

HUGO GERNSBACK, Editor

# RADIO CRAFT

**IN THIS ISSUE**  
A 1-Kw Radio-Frequency Heater  
Record Player for FM Receiver



**PULSE CODE MODULATION  
STOPS RELAY LOSSES**  
SEE PAGE 28



**FEB**  
1948

**30¢**  
CANADA 35¢

**RADIO-ELECTRONICS IN ALL ITS PHASES**

Laboratory Tests Prove  
that FEATURE for FEATURE

**AIR KING**

Portable WIRE RECORDER  
PHONO-COMBINATION



*Tops all Competition!*

Compare these features:

- **A record player too!** Plays 10"—12" records! Records from phonograph! Has Fidelitone permanent needle.
- **5 Tubes exclusive with Air King!** ... 5 tube amplifier (including rectifier) guarantees finest fidelity.
- **Has radio attachment!** At no extra cost there's a cable attached to record on wire from radio without use of microphone. This assures original high fidelity. Can also dub in voice (through mike) while recording from radio.

• **Practical, compact carrying case!** Housed in sturdy wooden luggage-type carrying case.

• **Console features in portable case!** Has the superior engineering qualities of a console wire recorder including automatic shut-off (motor shuts off automatically after wire rewinds)... safety lock that prevents accidental erasures... visual-tone indicator to maintain recording level... highly sensitive microphone with table stand makes it ideal for conference use... few simple controls, most easy to operate!

• **Price is complete...** includes these extras! Two spools of wire... cord for radio recording... microphone table stand.

**\$129<sup>50</sup>**

Including Federal Tax.  
(Slightly higher west  
of Rockies)

See Your  
**AIR KING**  
Distributor  
Today!



MODEL 750

AIR KING PRODUCTS CO., Inc., Brooklyn 32, N. Y.

**AIR KING RADIO**

Division of HYTRON RADIO & ELECTRONICS CORP.

*The Royalty of Radio Since 1920*





# I Will Show You How to Learn RADIO by Practicing in Spare Time

I Send You Big Kits of Radio Parts



**KIT 1**  
I send you Soldering Equipment and Radio parts; show you how to do Radio soldering, how to mount and connect Radio parts; give you practical experience.



**KIT 2**  
Early in my course I show you how to build this N.R.I. Tester with parts I send. It soon helps you fix neighborhood Radios and earn EXTRA money in spare time.

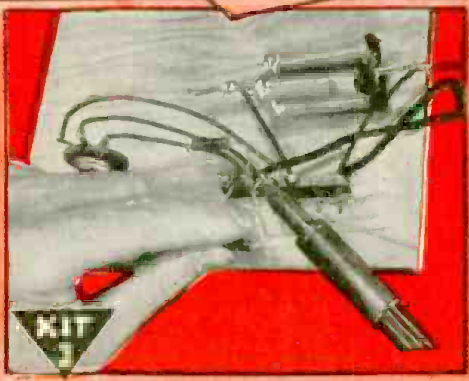

**KIT 3**  
You get parts to build Radio Circuits; then test them; see how they work; learn how to design special circuits, how to locate and repair circuit defects.

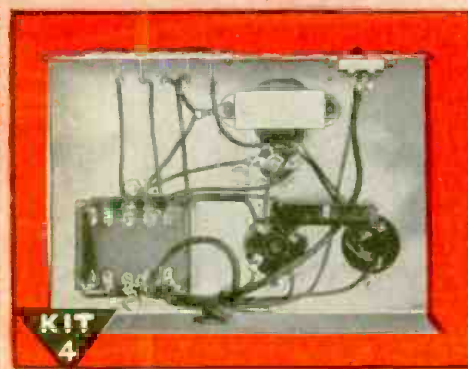

**KIT 4**  
You get parts to build this Vacuum Tube Power Pack; make changes which give you experience with packs of many kinds; learn to correct power pack troubles.

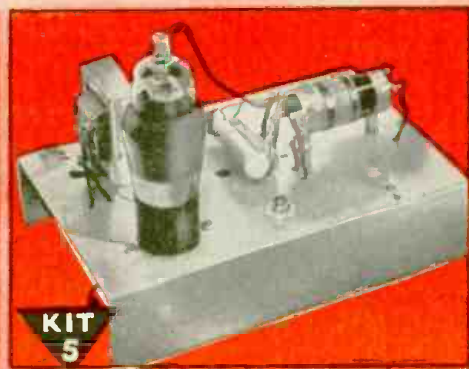

**KIT 5**  
Building this A. M. Signal Generator gives you more valuable experience. It provides amplitude-modulated signals for many tests and experiments.



**KIT 6**  
You build this Superheterodyne Receiver which brings in local and distant stations—and gives you more experience to help you win success in Radio.

## I Will Train You at Home - SAMPLE LESSON FREE

Do you want a good-pay job in Radio—or your own money-making Radio Shop? Mail Coupon for a FREE Sample Lesson and my FREE 64-page book, "How to Be a Success in RADIO—Television, Electronics." See how N. R. I. gives you practical Radio experience at home—building, testing repairing Radios with BIG KITS OF PARTS I send!

**Many Beginners Soon Make Good Extra Money in Spare Time While Learning**

The day you enroll I start sending EXTRA MONEY manuals. You LEARN Radio principles from my easy-to-grasp, illustrated lessons—PRACTICE what you learn with parts I send—USE your knowledge to make EXTRA money fixing neighbors' Radios in spare time while still learning! From here it's a short step to your own full-time Radio Shop or a good Radio job!

### VETERANS

You can get this training right in your own home under G. I. Bill. Mail coupon for full details.

### Future for Trained Men Is Bright in Radio, Television, Electronics

It's probably easier to get started in Radio now than ever before because the Radio Repair Business is booming. Trained Radio Technicians also find profitable opportunities in Police, Aviation, Marine Radio, Broadcasting, Radio Manufacturing, Public Address work. Think of even greater opportunities as public demand for Television, FM and Electronic devices continues to grow. Send for free book now!

**Our 34th Year of Training Men for Success in Radio**

My training includes TELEVISION • ELECTRONICS • FM

### Find Out What N.R.I. Can Do for You

Mail Coupon for Sample Lesson and my 64-page book. Read the details about my Course. Read letters from men I trained, telling what they are doing, earning. See how quickly, easily you can get started. No obligation! JUST MAIL COUPON NOW in an envelope or paste it on a penny postal. J. E. SMITH, President, Dept. 8BX, National Radio Institute, Pioneer Home Study Radio School, Washington 9, D. C.

## Good for Both - FREE

Mr. J. E. SMITH, President, Dept. 8BX, National Radio Institute, Washington 9, D. C. Mail me FREE, without obligation, Sample Lesson and 64-page book about how to win success in Radio—Television, Electronics. (No salesman will call. Please write plainly.)

Age .....

Name .....

Address .....

City ..... State .....

(Please include Post Office Zone Number)



APPROVED FOR TRAINING UNDER GI BILL

# War Surplus Bargains Sold As Used Unless Otherwise Specified!

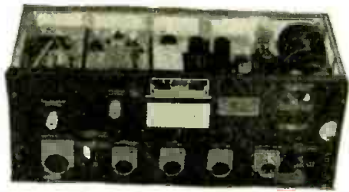

## RADIO ALTIMETER APN/1

A complete 460 mc. radio receiver and transmitter which can be converted for ham or commercial use. Tubes used and included: 4-12SH7, 3-12S17, 2-6H6, 1-VR150, 2-955, 2-9004. Other components such as relays, 24 V dynamotor, transformers, pots, condensers, etc., make this a buy on which you can not go wrong. Complete as shown in aluminum case 18"x7"x7 1/4".

**\$8.95**

## NAVY CRV-46151 AIRCRAFT RADIO RECEIVER

INCLUDING CASE

**\$19.50**

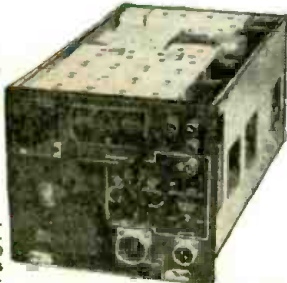

Four bands, including broadcast (195-9.050 KC). Circuit is six-tube super-heterodyne with mechanical band change or remote operated electrical band change. Remote band change and tuning controls included, making this set readily adaptable to mobile ham use. Powered from self-contained 24 V. DC dynamotor. The sets are complete with tubes, mounting rack and remote controls.

## AIRCRAFT TRANSMITTER BC-457A or BC-458A

Ideal to make over for master oscillator. Priced complete with tubes. Has built-in crystal for dial calibration. Used but in good condition. 5.3-7 MC or 4-6.3 MC FREE Mounting Rack with order of two or more.

**\$3.95**



## INTERPHONE AMPLIFIER RL-9

Convert to high fidelity phone Amp. or speech Amp. Complete with tubes and dynamotor, for 24 V. DC operation. Used but in good condition.



SPECIAL PRICE **\$1.75**

TERMS: CASH WITH ORDER

**AMERICAN SURPLUS PRODUCTS CO.**

537 N. CAPITOL AVE. INDIANAPOLIS, IND.

## ARC-4 TRANSMITTER & REC.

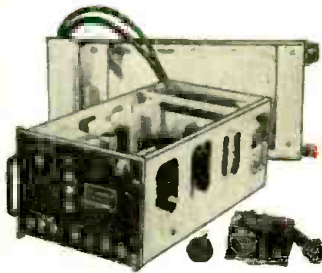

INCLUDING CASE

**\$17.95**

Operates on any of its 4 predetermined crystal controlled frequencies in the range of 140 MC. Complete with tubes, remote control, junction box, shock mounting base and connecting plugs. This unit is ideal for amateur UHF or mobile telephone. Operates from self-contained 24 V DC dynamotor. 12 V available upon request.

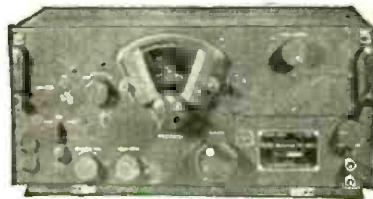

## BC-348

### Communications Receiver

Excellent selectivity, sensitivity and stability makes this the most outstanding of any receiver yet available from government surplus. This Receiver will give outstanding performance wherever used. Built to withstand vibration and features gear driven 100:1 ratio vernier tuning control. Six bands—500 Kc. and 1.5-18 Mc. Two stages RF, 3 stages IF, BFO, crystal filter manual or AVC. Complete with tubes and 24 V. DC dynamotor. Easily converted to 110V AC operation. BC-348, 110 V. AC power supply. Including simple conversion instructions .....\$8.95

**\$69.50**

## BRAND NEW SCR-625 MINE DETECTORS

ATTENTION, PROSPECTORS, MINERS, OIL COMPANIES, PLUMBERS, ETC.

Used by the Army to detect buried metallic mines. Its private use suggests the location of underground or underwater pipes, cables and ore-bearing rock, the location of metallic fragments in scrap materials, logs, etc., and the screening of personnel in plants for carrying of metallic objects. New, complete in original overseas packing container. Originally sold by War Assets for \$166.00. The U. S. Forestry Service has recommended procedure for using the SCR-625 Mine Detector to find concealed metal in tree logs and other timber products.

**\$79.50**

## R-5/ARN-7 RECEIVER

Three bands 200 to 1750 KC. Complete with 17 tubes required. This set is ideal for conversion to home broadcast Receiver addition to ham shack, etc. Reported sold for many times the price when brand new. A Receiver that would be hard to pick up at this price. ONLY **\$31.50**

PRICES F.O.B. INDIANAPOLIS

## NEW WILLARD RECHARGEABLE STORAGE BATTERIES



New 6 Volt battery in spill-proof clear plastic case, housed in metal case for easy mounting. Applicable for a wide range of uses where battery power is needed. Shipped dry. Uses standard battery electrolyte available everywhere.

Price, each ..... **\$4.00**  
In lots of ten, each ..... **\$3.35**  
Without metal case ..... **\$3.00**  
In lots of ten, each ..... **\$2.95**

## AN/ART B COLLINS

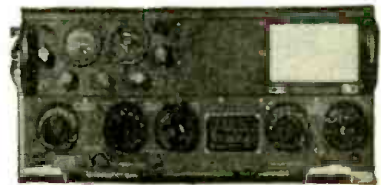

## AUTO TUNE TRANSMITTER

A modern, compact, lightweight, high-powered transmitter. For frequency range 2-18.1 Mc. on any of its 11 auto tune crystal controlled or master channels. These units removed from planes. Checked and guaranteed. Weight, 67 lbs.

**\$134.50**

WITH DYNAMOTOR UNIT & CONTROL HEAD

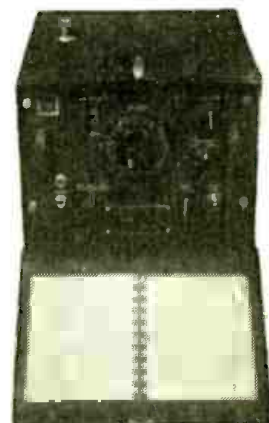

## BC-221 FREQUENCY METER

Covers 125-20,000 Kc. Battery or 110 V. AC v-brack operated. Beautiful equipment.

**\$49.95**



## OXYGEN TANKS

These oxygen tanks, removed from surplus aircraft, have a capacity of 500 lbs. pressure. Type D2, with complete regulator assembly. Size of tank 22"x5".

**\$6.95**

TERMS: CASH WITH ORDER

**AMERICAN SURPLUS PRODUCTS CO.**

537 N. CAPITOL AVE. INDIANAPOLIS, IND.

# Sustained CAPACITY

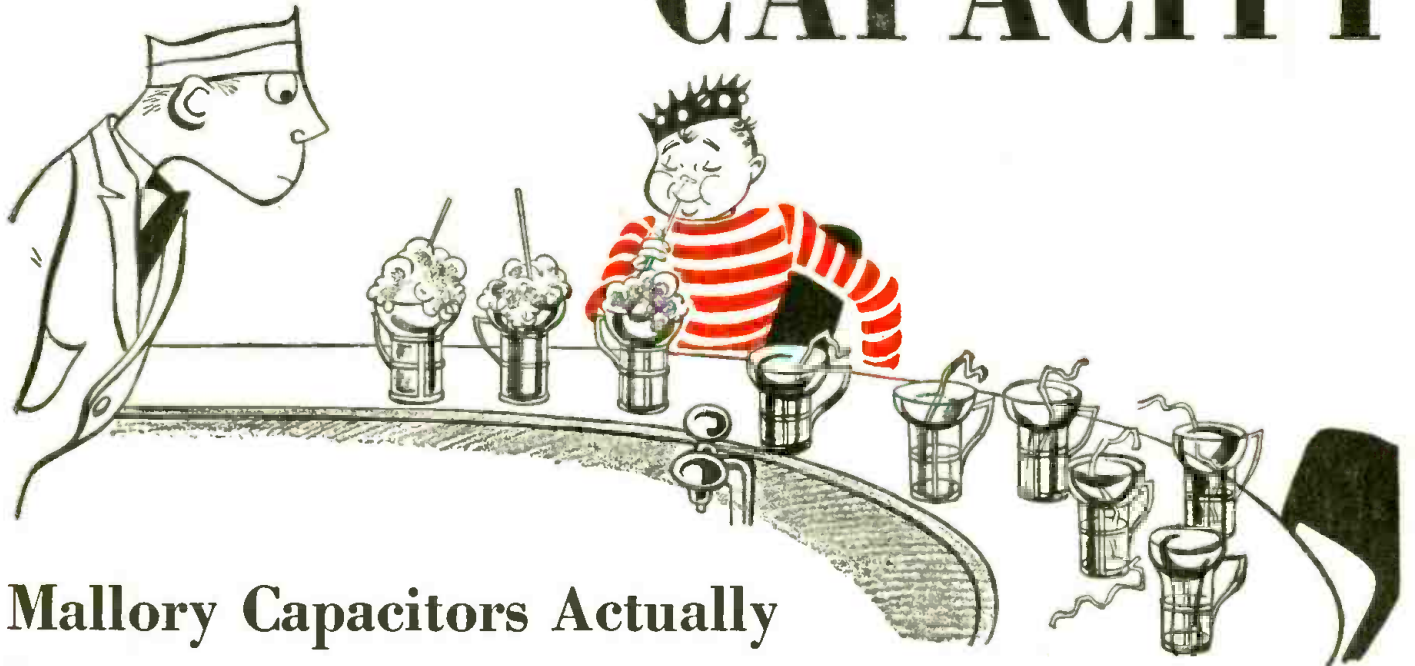

## Mallory Capacitors Actually Increase in Capacity After 2,000\* Hours

Install Mallory FP Capacitors with the knowledge that they will last in a "hot set" with temperatures up around 185° F.—they will last on the shelf or in an inactive set without needing reaging—and they will last without loss of capacity.

Their RF impedance—their ability to withstand ripple current, are other plus values that make Mallory capacitors popular with radio service men, as well as with manufacturers of radio equipment.

### THE MALLORY "GOOD SERVICE FOR GOOD BUSINESS" PLAN

will increase business and profits in your shop.

A unique follow-up file makes it easy to keep customers.

You tie in with Mallory acceptance to develop new business—ask your distributor about it.

Mallory is never satisfied to produce parts that just get by. In all Mallory Parts you will find a generous margin in your favor. Mallory capacitors will operate at 185° F.—that's 35° hotter than R. M. A. requirements.

### \*2,000 HOURS OF OPERATION

An actual test of Mallory capacitors operated in an oven at 185°F. and 450 volts DC, plus 10 volts of 120 cycle ripple, showed them still going strong and with increased capacity at the end of 2,000 hours. Typical results:

At Start of Test		After 2,000 Hours	
Capacity	Resistance	Capacity	Resistance
20.9 mmf	6.16 ohms	23.5 mmf	6.5 ohms
20.1 mmf	6.5 ohms	23.4 mmf	6.55 ohms

BUY MALLORY ASSURED QUALITY AT REGULAR PRICE LEVELS

**P. R. MALLORY & CO. Inc.**  
**MALLORY** CAPACITORS . . . CONTROLS . . . VIBRATORS . . .  
 SWITCHES . . . RESISTORS . . . RECTIFIERS . . .  
 VIBRAPACK® POWER SUPPLIES . . . FILTERS  
\*Reg. U. S. Pat. Off.  
**APPROVED PRECISION PRODUCTS**

**P. R. MALLORY & CO., Inc., INDIANAPOLIS 6, INDIANA**

McMurdo  
**SILVER**

**NEW!**

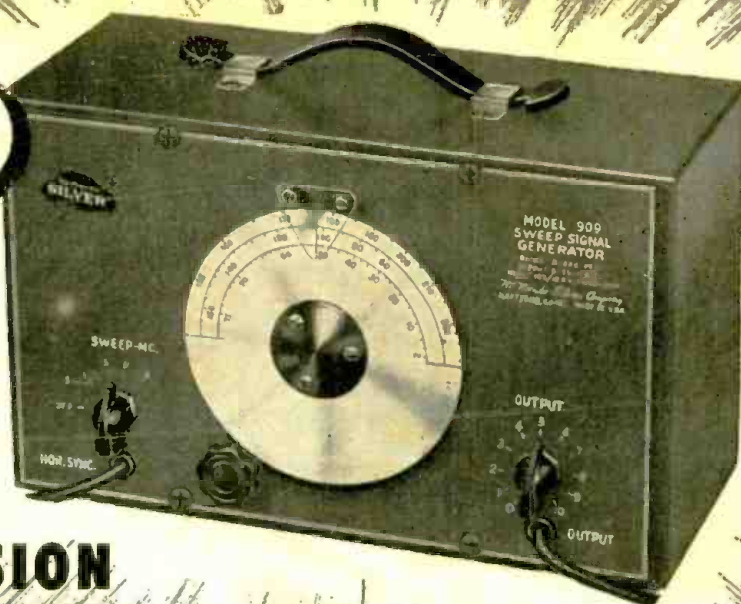

## FM & TELEVISION SWEEP SIGNAL GENERATOR

Here's what you and thousands of research and service technicians have demanded... a frequency-modulated FM and TV sweep signal generator. With this new McMurdo Silver MODEL 909 you can align your scope and can visually align FM and TV receivers... quickly and perfectly... for it comes with simple but complete instructions to put you at the head of the parade in FM and TV service.

Quality and completeness are as high as price is low... the regular "trademark" of Silver LCETI... Laboratory Caliber Electronic Test Instruments at prices you can afford.

**CENTER-FREQUENCY RANGE** 2/226 mc. — 5" vernier-driven calibrated dial. A new Silver development covers 2/77, 70/154 and 151/226 mc. in 3 bands without band-switching!

**STABILITY** is extraordinary. New u.h.f. tubes give stability such that FM and TV 'scope pictures once set up will "stay put" for hours on end.

**SIZE AND STYLE** match "VOMAX" and all Silver LCETI. Power required is 105/125V., 50/60 a.c. at 35 watts. Size 12 $\frac{3}{4}$ " x 7 $\frac{3}{8}$ " x 6" overall.

**CO-AXIAL OUTPUT CABLES.** 3 ft., d.c. isolated, 5/125  $\Omega$  impedance for r.f.; separate horizontal synchronizing cable. Both with clips for direct connection to receiver circuits.

**SWEEP FREQUENCY** is panel-knob variable 0/9 mc. . . . to set correct sweep for FM and TV i.f. and r.f. alignment. True electronic, not distorting and troublesome mechanical sweep.

**SYNCHRONIZATION** is either power line sine wave, or sawtooth to 'scope from 909. R.F. OUTPUT is panel-knob controllable 0/500,000 microvolts maximum. More than ample for all visual alignment with any good oscilloscope.

**MODEL 909 FM & TV SWEEP SIGNAL GENERATOR** makes you master, not victim, of today's most profitable service fields . . . at a price which is already the amazement of the industry!

Model 909 ..... Only \$48.50 Net



**900 "VOMAX"** 51 ranges; d.c., a.c., a.f., i.f., r.f., 20 $\nu$ /500 mc. 0/3000 V. d.c.; 0/1200 V. a.c., current 0/12 A. ; resistance 0/2000 meg $\Omega$  ; db.—10/+50. The overwhelming choice of wise research and service technicians.  
Only \$59.85 Net

**904 CONDENSER/RESISTOR TESTER.**  $\frac{1}{4}$  mmfd./1000 mfd.;  $\frac{1}{4}$   $\Omega$  /1000 meg $\Omega$  ; variable d.c. polarizing voltage leakage current; 0/50% power factor. Laboratory accuracy of  $\pm 3\%$ . Measures all condensers with 0/500 V. rated d.c. volts applied.  
Only \$49.90 Net

**905 "SPARX" DYNAMIC SIGNAL TRACER/TEST SPEAKER.** Traces a.f., i.f., r.f. signals thru any receiver, tests pick ups, mikes, PA amplifiers. 20  $\nu$  /200 mc. Saves time in receiver repairs as does no other single instrument  
Only \$39.90 Net

**906 FM/AM SIGNAL GENERATOR.** 8 ranges,  $\pm 1\%$  accurate, 90 kc./210 mc. 0/100% AM, 0/1000 kc. FM modulation. Less than 1 microvolt to over 1 volt metered output. The outstanding signal generator buy.  
Only \$99.50 Net

SEND FOR COMPLETE CATALOG. See these and Silver communication transmitters, receivers, "Micromatch", Xtal-controlled VFO, pretuned freq. multiplier at your jobber.

OVER 36 YEARS OF RADIO ENGINEERING ACHIEVEMENT

*McMurdo Silver Co., Inc.*

EXECUTIVE OFFICES: 1240 MAIN ST., HARTFORD 3, CONN.  
FACTORY OFFICE: 1249 MAIN ST., HARTFORD 3, CONN.



**I Put You to Work with Your Hands to LEARN RADIO!  
You Build Receivers! You Make Typical Defects Occur  
and Make Tests to Prove the Theory!**

**YOU GET  
8 BIG KITS OF RADIO  
PARTS & EQUIPMENT  
including  
2-BAND SUPER  
RECEIVER!  
and 16 RANGE METER  
FOR TESTING**

**LEARN RADIO  
to MAKE MONEY!**

**LOW COST TRAINING — EASY PAYMENT PLAN!**

**You Learn at Home How to  
Build and Test Dozens and  
Dozens of Circuits — Simple  
and Complex!**

**YOU DO  
OVER 175  
INSTRUCTIVE  
EXPERIMENTS**



**YOU BUILD  
ALL THESE TESTERS  
..... AND MORE!**

I give you a fine, moving-coil type Meter Instrument on Jewel Bearings — with parts for a complete Analyzer Circuit Continuity Tester. You learn how to check and correct Receiver defects with professional speed and accuracy.

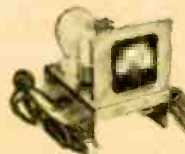

You'll get valuable experience and practice building this Signal Generator and multi-purpose Tester. Makes a breeze out of fixing Radios and you don't have to spend money on ready-made Equipment.

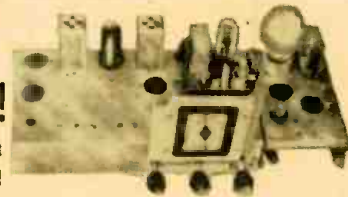
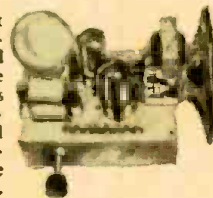

Soldering, wiring, connecting Radio parts . . . building circuits with your own hands — you can't beat this method of learning. When you construct this Rectifier and Filter, Resistor and Condenser Tester, etc., you get a really practical slant on Radio that leads to a money-making future.

F. L. SPRAYBERRY, PRES-  
IDENT of the SPRAYBERRY  
ACADEMY OF RADIO. This  
is the man who directs  
your study. His years of  
experience and Radio  
"know-how" assure you of  
the finest in home Radio  
Training!



**Set has Long and  
Short Wave Tuning.  
All Sprayberry Equip.  
is yours for KEEPS.**

**SPRAYBERRY HOME TRAINING is PLANNED to MAKE MONEY for you FAST!**

I train you with regular professional Radio Equipment. I tell you exactly what to do . . . how to do it. You handle Radio Parts, see them operate, learn what they're for. With the fine Kits I supply, you learn how to build Radio Circuits, construct your own Test Equipment. I'll show you how to cause typical Radio defects so you can watch and see how they act. You learn the latest methods for trouble-shooting and repair. All this adds up to

the finest kind of "bench" experience. And you get it right in your own home. In no time at all, you'll be ready for a business of your own or a good job in Radio, FM, Television, Radar, Industrial Electronics, etc. Now's the time to get started!



**SEND FOR MY  
VALUABLE  
FREE BOOKS!**

**VETERANS**

Approved for G.I. Training under  
Public Laws 16 and 346.

F. L. Sprayberry, Pres.  
SPRAYBERRY ACADEMY OF RADIO,  
2028 Sprayberry Bldg, Pueblo, Colo.

Please rush my FREE copies of "How to MAKE MONEY in RADIO, ELECTRONICS and TELEVISION" and "HOW to READ RADIO DIAGRAMS and SYMBOLS."

Name ..... Age .....

Address .....

City ..... State .....

Check here if a Veteran

READ WHAT GRADUATE SAYS:  
"One Job Nets About \$26.00" "Since last week I fixed 7 radios, all good paying jobs, and right now I am working on an amplifier system. This job alone will net me about \$26.00. As long as my work keeps coming in this way, I have only one word to say and that is "Thanks" to my Sprayberry training and I am not afraid to boast about it." ADRIEN BENJAMIN, North Groves-nordale, Conn.

**TRANSFORMERS**

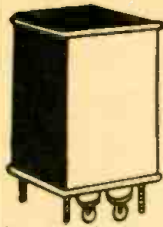

Power xfmr. Pri: 117v. 60 cy. Sec: 330-0-330 v. @ 85 ma. 5v. @ 2 amp. 6.3 v. @ .3 amp. 6.3 v. @ 7.5 amp ..... \$1.95

Power Pair: Xfmr 470 v.ct. @ 60 ma. 6.3 v. @ 1.65. 5v. @ 2 amp. PLUS a 6by 50 ma. choke. Both for only ... \$1.75

**Filament Transformers**

(All primaries 117v., 60 cy.) #5126: 5v. @ 3 amp., 5v. @ 3 amp., 5v. @ 6 amp. (All center tapped) \$2.25  
#5100: 6.3 v. ct @ 1.2 amp. .... \$1.35  
#5085: 6.3 v. @ 6 amp. 6.3 v. @ 1.5 amp. .... \$1.40  
UX 6899: 5 v. @ 5.5 amp. 5 v. @ 5.5 amp. 29.000 volt test ..... \$24.50

**CHOKES**

6 Hy @ 150 Ma ..... \$1.50  
6 Hy @ 300 Ma ..... \$3.25  
1 Hy @ 800 Ma. 7.5 ohms ..... \$8.95  
Dual choke, 2 Hy @ 100 ma ..... \$ .90  
Dual choke, 7 Hy @ 75 Ma, 11 Hy @ 60 Ma ... \$1.50  
8.5 h. @ 150 ma. .... \$1.50  
25 h. @ 65 ma. .... \$1.10

**PE 73 CM Power supply for BC 375. Input: 28 VDC. Output: 1000 VDC @ 350 Ma. starting relay, filter, etc. New \$4.95**

**DYNAMOTORS**



Mfrs.: Write for quantity, prices & discounts on above item.  
**BD 77, Power supply for BC 191. Input: 14 VDC. Output: 1000 VDC @ 350 Ma. New, with spare fuse links, etc. \$5.95**

**PE 101C, Input: 13/26 VDC @ 12.6/6.3 A. Output: 400 VDC @ 135 Ma., 800 VDC @ 20 Ma. (9VAC @ 1.12 A.) \$3.49**

**PE 86 N. Input: 28 VDC. Output: 250 VDC @ 60 Ma. Westinghouse w/Filter ..... \$1.95**  
Without Filter ..... \$1.60

**PC 77, Input: 12 VDC. Output: 275 VDC @ 110 Ma. 500 VDC @ 50 Ma. .... \$3.25**

**DAG 33 A, Input: 18 VDC @ 3.2 A. Output: 450 VDC @ 60 Ma. .... \$2.45**

**DM 33A, Input: 28 VDC @ 7 A. Output: 540 VDC @ 250 Ma. Power supply for modulator of SCR 274 N ..... \$3.95**

**Dyn. Model 23350. Input 27 VDC @ 1.75 A. Output: 285 VDC @ 75 Ma. .... \$1.75**

**DM-21: In 14VDC 3.3A Out 235VDC 90 ma. with filter ..... \$2.59**

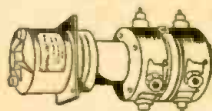

**MOTOR DRIVEN SWITCH**  
Switch operates at 1800 rpm, using internal 24 VDC motor. Switch is DPDT, and was originally designed for automatic switching of YAGI radar antennae ..... \$2.00

**WIRE RECORDING MAGAZINES**  
Magazine for KS 1200 D recorder, made by W. E. Comes with wire for 1/2-hour recording. Has elapsed time indicator, recording and erase features. Size 14 1/2" Lx7" Wx3 1/2" H. Less Drive Motor ..... \$30.00

**140-600 MC DIRECTIONAL ANTENNA**  
140-310 Mc cone and 300-600 Mc cone, each consisting of 2 end fed half wave conical sections with enclosed matching stub for reactance changes with changing frequency. New, complete with mast, guys, cables, carrying chest ..... \$49.50



**GIBSON GIRL EMERGENCY XMTR**

Transmits automatic SOS signal on 500 kc emergency wave. Can be manually keyed to transmit additional information. No Batteries required. Hand cranked. \$25.00

**BC 1160 A RADAR TRANSMITTER**  
Range: 150-200 Mc. 115 VAC. 60 cy. Many Valuable parts: Blower, GR Variac, 10 tubes including 807 and 2X3, complete power supply. Size: 18x20x17 1/2". Weight 150 lbs. .... \$45.00

**MacKay Radio Transmitter**

Model 167-BY. CW Xmtr with range 2 to 24 mc. Power output: 200 Watts from 2 to 16 mc, 150 Watts from 16 to 24 mc. Complete, with 110 VDC rotary power supply ..... \$350.00

**CROSS POINTER INDICATOR**



Two 0-200 microampere movements, 3" case, many applications ..... \$2.50

**RADAR AIRCRAFT**

**"Communications"**

**AMATEUR INDUSTRIAL**



**INDICATOR BC 104-A**

Part of radar set SCR 521. Makes an excellent foundation unit for a high gain scope. Uses following tubes: 4-6AC7, 3-6HG, and 5BP1 CR tube. Comes enclosed in metal shield. New, less power supply, in wooden carrying chest ..... \$17.50

**CATHODE RAY TUBES**

3BP1 .....	\$1.25	5BP4 .....	\$1.60
3FP7 .....	\$1.20	5BP1 .....	\$1.20
5FP7 .....	\$1.75	5JP2 .....	\$4.00

**RECTIFIER TUBES**

872A .....	\$1.00	705A .....	\$1.25
355A .....	\$5.00		

**PUT YOUR SURPLUS EQUIPMENT TO WORK.**  
24 volt filament transformers Input: 117V, 60 cy. output 24V at 3 amp ..... \$1.50

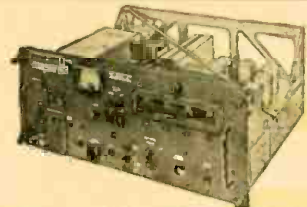

**BC 1267 Transmitter & Receiver**  
1 KW pulse oscillator on 154 to 186 mc. Can be converted to CW or voice operation on 144 to 148 mc. band. Receiver is a superhet with 2 stages of RF, 5 stagger tuned IF stages. Plenty of room on chassis for additional stages & changes. New. W/tubes. In original crate ..... \$75.00

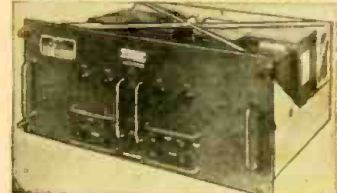

**Power Supply RA105A**  
Input: 117 V, 60 CPS. Output: 2000 VDC, 2000 VDC, 610 VDC, 415 VDC, 300 VDC, 290 VDC, 160 VDC, and 6.3 VAC, 60 CPS. New. W/tubes ..... \$40.00

**Indicator I-221**  
Remote antenna direction controller & indicator, using 2 Selsyn motors. Servo unit controls direction of antenna, 360 deg. rotation. Operates on 117 VAC, 60 cps. New. W/tubes ..... \$50.00

**RACK, FM 79** For housing above 3 units. Has self contained blower, built-in cables & plugs, & interlocking devices. New ..... \$35.00

**Control Unit BC 1073**  
Consists of pulse-generator and wavemeter which measures frequencies from 150 to 210 mc. The pulse generator makes an excellent square-wave generator with variable pulse-widths. The wavemeter can be modified into a UHF oscillator, 117 VAC, 60 cps operation. W/tubes ..... \$50.00

**Antenna, AN 128 A**  
2 parallel vertical dipoles working against a square reflector. Impedance is 50 ohms. Broad bandpass. Makes an ideal antenna, with high gain & directivity on 2 meters. New-original case ..... \$40.00

**Complete Set RC 148**  
Xmtr & Rcvr BC 1267 & power supply RA-105. Both units with tubes ..... \$47.50

**Complete Transmitter and Receiver RC-145**  
BC 1267, RA 105 A, Indicator I 221, may be operated as independent units, or the complete set of components combined to form a unit may be purchased at this special price. With mounting rack. New ..... \$190.00 (Gov't cost ..... \$5000.00)

**MINE DETECTOR AN/PRS I**  
Will indicate buried metallic & nonmetallic objects, such as water pipes, sewer pipes, tree roots, water pockets, etc. Uses earphones and meter for aural and visual indicators. Operates on principle of changes in radiation resistance. An ideal gadget for campers, geologists, home-owners. New, complete ..... \$12.75  
With Batteries ..... \$21.65

**HEADSETS**

Dynamic mike and headset combination. A high quality, efficient unit, used in E-10 tank Xmtrs. Mike & phones complete, new as shown ..... \$2.75

**HS 30 HEADSET:** A feather-weight headset with insert type phones that cut background noises to a minimum. Low impedance (500 ohms) assures efficiency & high fidelity 5.85 Matching transformer to match 500 ohms to 8000 ohms output ..... \$3.35

R-15 headsets: 8000 ohms impedance, rubber cushions. Comes with 8' cord & plug. Pl. 55. New ..... \$1.95  
Used, in good condition ..... \$3.60

**SONAR SOUND DETECTION UNIT**

Ideal for detecting under water sounds, such as fish swimming in schools, within a 15 mile area. Using a Rochelle salt crystal, which is about 1000 times more sensitive than quartz. It is completely enclosed in a solid rubber sheath. This sound detector was originally used in harbor defense. Coupled to an audio amplifier, this can be found to have many valuable applications. It's the Model JR which contains 7 microphone units \$12.50

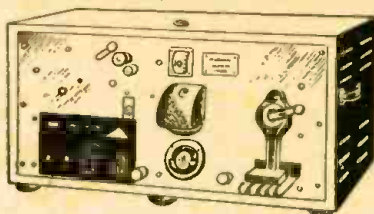

**MCELROY TG-10 KEYER**

Makes excellent code practice machine, using tape or key. Variable words-per-minute adjustment. Clean quick keying, using photocell. Operates on 110 V, 60 cycle. Slightly used, but in excellent condition. Less tubes ..... \$15.00

**MICROWAVE TUBES**

(Magnetrons)

2T32 .....	\$15.00	2T21 .....	\$15.00
Magnet for 2T32 ..	\$ 8.00	2T21A .....	\$15.00
2T38 with magnet	\$25.00	2T22 .....	\$15.00
2T55 with magnet	\$25.00	2T26 .....	\$15.00
3T31 .....	\$17.50	2T31 .....	\$15.00
Magnet for 3T31 ..	\$ 8.00		

W.E. 700A (L band) ..... \$45.00  
W.E. 720BY (S band) 1000 Kw. .... \$25.00  
QK 59, QK 60, QK 62, tunable packaged magnetrons, 10 cm. Ea. .... \$45.00  
Klystron-2K25-723-AB ..... \$3.50

**24-VOLT AUDIO AMPLIFIER**

BC 686-A, Bendix audio amplifier, operates on 24 v.d.c. Uses 3-25L6. New, less handset and tubes. Size 19"x10 1/2"x8" ..... \$19.95

**HIGH FREQUENCY PM TWEETERS** 8 ohm impedance, heavy duty, 1 1/2" cone and voice coil. Up to 15,000 cycle reproduction. Weight 4 1/2 lbs. New with spare cone \$4.95



**Tuning Units**

From TCE & GP-7. Ideal basis for ECO rig. Ranges: A 350-800 kc. B 800-1500 kc. C 1.5-8mc. E. 4.525-6.5mc. F6.2-9.05 mc. Complete set of 5 \$11.00

Units C.F. .... Each \$2.25  
Units A.B.E. Each \$2.00



From BC 191 & BC 375 TU 6B, 3000 kc to 4500 kc. TU 6B-7700 to 10,000 kc, TU 10B-10,000 to 12,500 kc, TU 22 B 350 to 650 kc. Will supply closest unit to Specined Frequency, at time of shipment. Each, \$2.75

**INSULATORS**

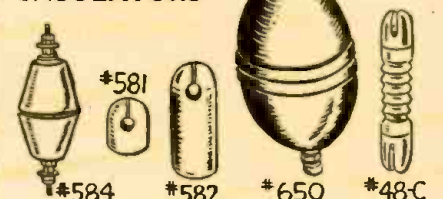

#650: Ladd-bowl feed thru. Similar to National XS 3. Made of high quality glazed porcelain. Fits 2 1/2" hole. 6 1/2" L x 3" diam. .... \$1.50

#584: Feed-thru. Made of steatite. Similar to National XS 1. Fits 1 1/2" hole. 5" L x 1 1/4" diam. .... \$4.49 or 4 for \$15.00

#582: Antenna feeder support. Holds twinex line also. 3" L x 1 1/4" diam. Hole size: 3/8". Each \$1.17 or 10 for \$11.00

#581: Same as #582, except it is 1 1/2" Long. Each \$1.12 or 12 for \$13.00

#48C: Antenna support insulator. Made of fine quality steatite, with nickel plated reinforced ends. Non-corrosive, 4" L x 5/8" diam. .... Ea. \$2.5

Antenna Feed Thru Insulator: 3" cup-shaped pair with flexible whip antenna mounting. Can be used either as feed-thru or whip & mast base. A MUST at this low price ..... \$1.00

All merchandise guaranteed. Mail orders promptly filled, prices F.O.B. N. Y. C. Send Money Order or Check. Rated Concerns send P.O. Shipping charges only send C.O.D. Send for Flyers.

**COMMUNICATIONS EQUIPMENT CO.**  
131-C LIBERTY ST., NEW YORK 7, N.Y. TELEPHONE DIGBY-9-4124



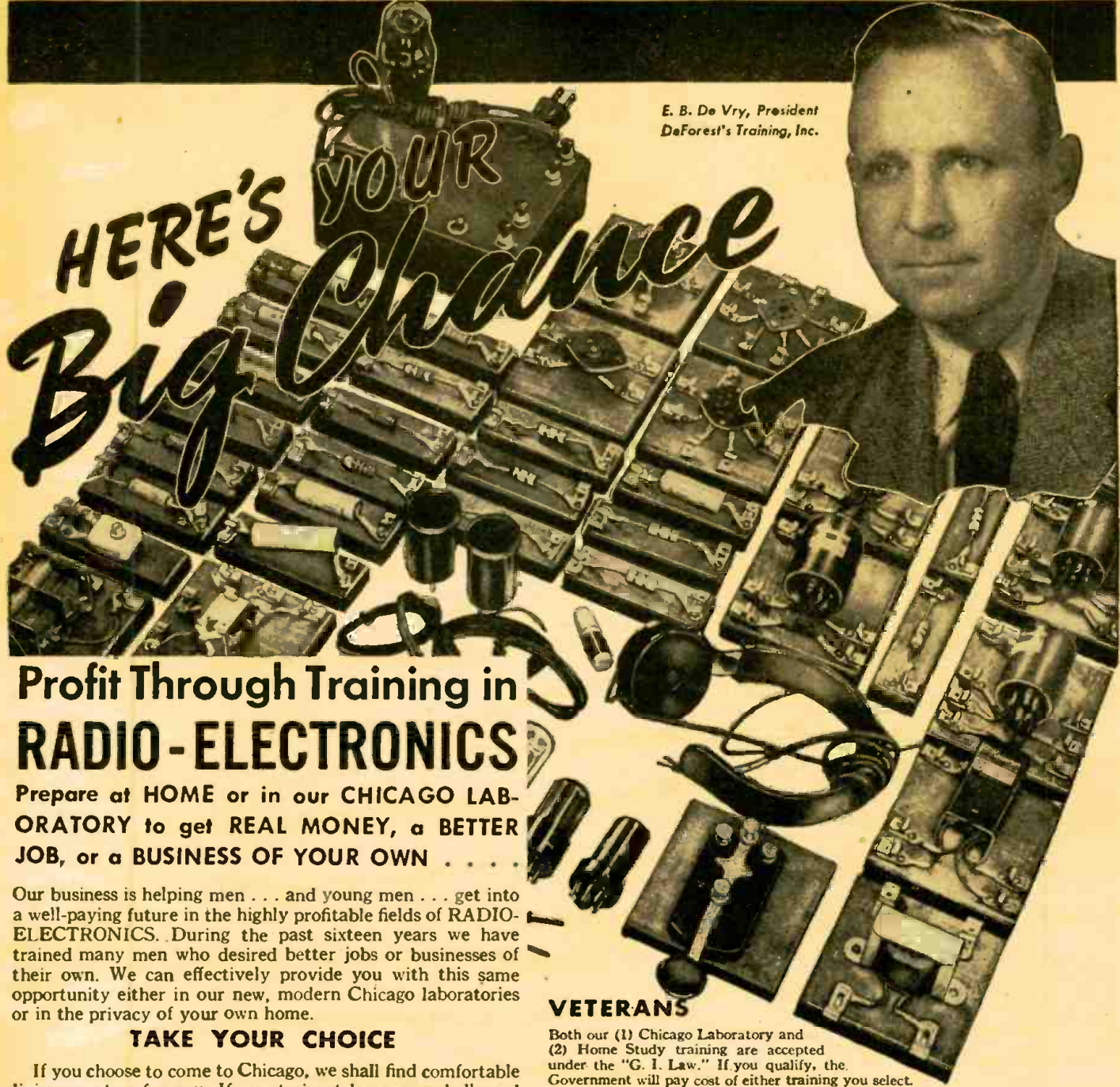

E. B. DeVry, President  
DeForest's Training, Inc.

# HERE'S YOUR Big Chance

## Profit Through Training in RADIO-ELECTRONICS

Prepare at HOME or in our CHICAGO LABORATORY to get REAL MONEY, a BETTER JOB, or a BUSINESS OF YOUR OWN . . . .

Our business is helping men . . . and young men . . . get into a well-paying future in the highly profitable fields of RADIO-ELECTRONICS. During the past sixteen years we have trained many men who desired better jobs or businesses of their own. We can effectively provide you with this same opportunity either in our new, modern Chicago laboratories or in the privacy of your own home.

### TAKE YOUR CHOICE

If you choose to come to Chicago, we shall find comfortable living quarters for you. If you train at home, we shall send you modern, practical equipment. In either of these two methods, you will have the supervision of some of the finest instructors in the country. Fill in coupon below and we shall send you, absolutely FREE, full information about our program of building men for better opportunities in RADIO-ELECTRONICS. DeForest's Training, Inc. also includes instruction in FM Radio, Television and Industrial Electronics.

If you prefer to remain at home, you receive eight (8) big kits of radio parts and assemblies from which you can work out dozens of fascinating radio circuits to gain practical experience in your own home. In addition, you receive a 16 mm. motion picture projector and 12 information-packed reels of film which help you learn faster . . . easier. You also get modern looseleaf lessons with handy fold-out diagrams.

### EMPLOYMENT SERVICE

When you complete your training our effective Employment Service helps you get started toward a real future. Mail coupon below today . . . do not delay.

### VETERANS

Both our (1) Chicago Laboratory and (2) Home Study training are accepted under the "G. I. Law." If you qualify, the Government will pay cost of either training you select.

## MAIL THIS OPPORTUNITY COUPON NOW!

Mr. E. B. DeVry, President  
DeForest's Training, Inc.  
2533 N. Ashland Ave., Dept. RC-2  
Chicago 14, Illinois

Please show me how I may get started toward a good job or a business of my own in Radio-Electronics.

Name.....Age.....

Address.....Apt.....

City.....Zone.....State.....

If under 16, check here for special information.

If a discharged Veteran of World War II check here.

# DeForest's Training, Inc.

CHICAGO  
ILLINOIS

Associated with the DeVRY Corporation  
Builders of Movie & Electronic Equipment

# Television stations get programs by telephone lines, too

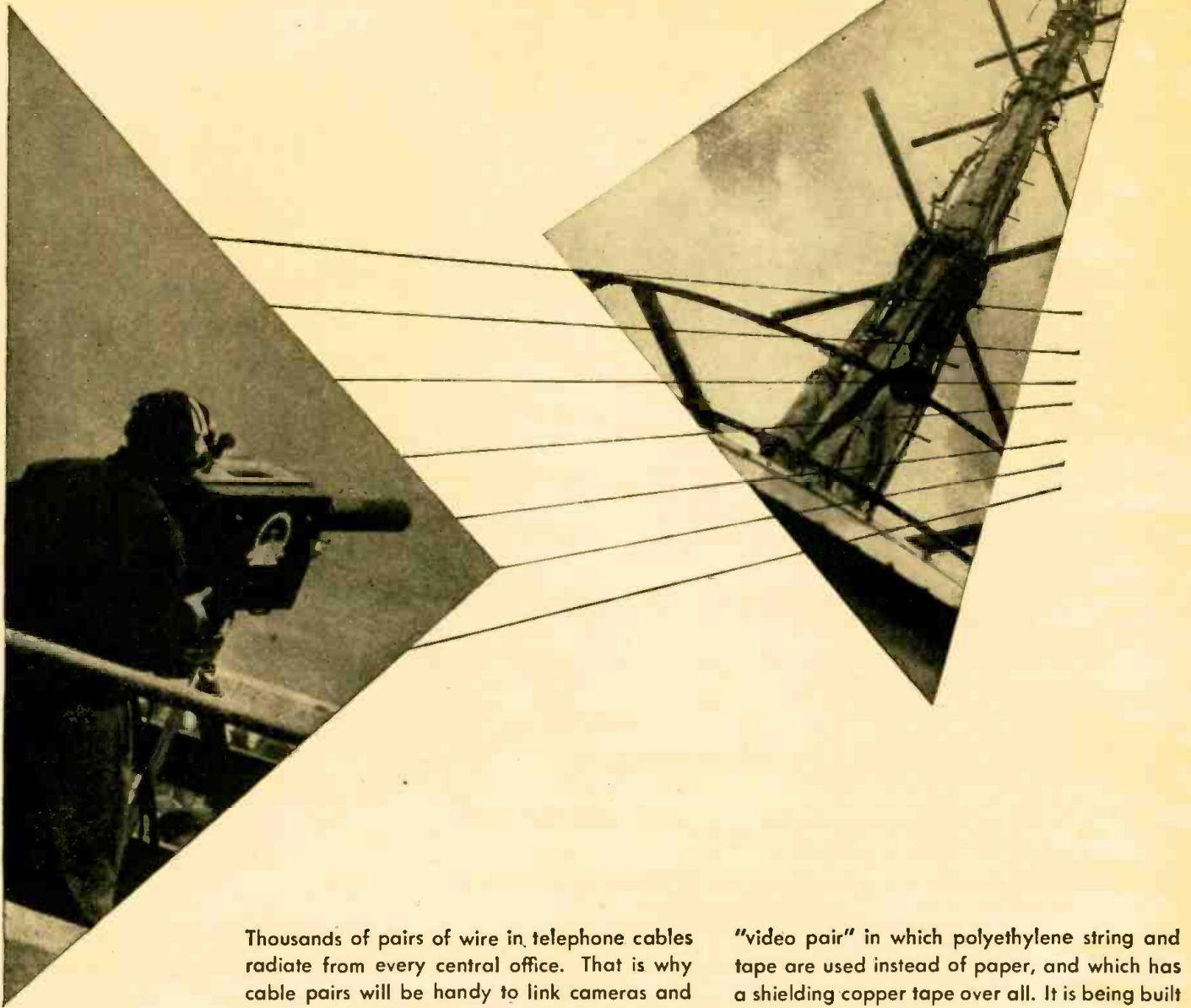

Thousands of pairs of wire in telephone cables radiate from every central office. That is why cable pairs will be handy to link cameras and transmitters wherever a television program may originate.

Since cable pairs are designed first for voice transmission—top frequency, about 3200 cycles per second—the loss at picture frequencies up to 4,000,000 cycles is high, so an amplifier is inserted about every mile. Equalizing networks are also needed to bring the losses at all frequencies to the same value.

Recently, the Laboratories have developed a

“video pair” in which polyethylene string and tape are used instead of paper, and which has a shielding copper tape over all. It is being built into new telephone cables which go to points where television programs are certain to originate. Losses are so much less that amplifiers can be four miles apart.

Inside an all-weather sheath, “video” travels safely and reliably alongside your telephone call, a sound program, telegraph signals, pictures for tomorrow’s papers. This service of the telephone cable was ready when television needed it because of Bell Laboratories activity.



**BELL TELEPHONE LABORATORIES** *EXPLORING AND INVENTING,*

*DEVISING AND PERFECTING, FOR CONTINUED IMPROVEMENTS AND ECONOMIES IN TELEPHONE SERVICE,*

RADIO-CRAFT for FEBRUARY, 1948

**WE BRING NATIONAL SCHOOLS  
TO YOU FOR  
HOME TRAINING IN RADIO  
TELEVISION & ELECTRONICS**



RADIO SHOP AT NATIONAL



BROADCAST STUDIO AT NATIONAL

Partial View of the Facilities that Stand Behind Your National Schools Home Training

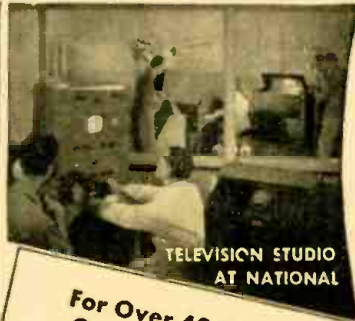

TELEVISION STUDIO AT NATIONAL



Since 1905

**For Over 42 Years  
One of America's  
Leading Trade Schools**

**NATIONAL SCHOOLS SHOP METHOD  
HOME TRAINING WILL START YOU RIGHT**

We will train you today to get started tomorrow in one of the thousands of opportunities opening in the field of Radio, Television and Electronics. The Home Radio Service Field continues to grow. Television is here . . . Television Broadcasting facilities are being rapidly expanded. Television sales, service, installation and maintenance requirements are more and more important from day to day. Electronics is an important factor in many applications for utility, safety, accuracy and convenience. Airlines are finding new uses for Radio bringing new benefits to air transportation. Ships at sea are employing Radar together with other conventional Radio apparatus for ship-to-shore communications and safety. Frequency Modulation is modernizing Radio Broadcasting, offering static-and-interference-free reception in the home. The list of Radio applications is almost endless, and every one represents increasing opportunities in our modern world for the RADIO, TELEVISION AND ELECTRONICS TECHNICIAN WITH A SOLID TECHNICAL BACKGROUND.

**YOU CAN BE A NATIONAL SCHOOLS MAN**

It is not a question of opportunity but rather how to take advantage of existing opportunity. Only proper training can make these opportunities a reality. National Schools of Los Angeles, one of the oldest and largest technical trade schools in the United States, offers you Shop Method Home Training, a proved method that builds qualified technicians. Here is Home Training that BRINGS RESULTS.

Behind all training from National Schools stands a permanent faculty of experienced instructors and engineers. These men are daily teaching resident students right in our own Shops and Laboratories. From first hand experience with students here at school, our instructors understand the needs and ambitions of men like you. All of our instructors, both Home Study and Resident, have ideal facilities to make your training practical, up-to-the-minute, interesting. It takes years of experience to know how to train men, especially in the practical technical trades. Established almost 50 years ago, National Schools has a rich background of experience to help you to take full advantage of the opportunities in the Radio, Television and Electronics Industry.



**Begin Training at Home  
Later Come to Our Shops and  
Laboratories in Los Angeles**

**—If You Prefer**

National's Master Shop Method Home Training in Radio, Electronics and Television is COMPLETE in itself. No other training is necessary; but, some men do prefer to take a short experience course here in our resident shops and laboratories, at the end of their Home Study training. They find it helpful to spend a short period of time in our modern Broadcasting Station, or our New Television Laboratories and Studios, or our Extensive Radio Servicing Shops—as well as other departments covering every specialized phase of the Radio Industry.

You are welcome to take advantage of this additional instruction if you wish. If you are interested, check the coupon below. Full details will be sent you by return mail. National Schools' OUTSTANDING FACILITIES MAKE IT POSSIBLE TO OFFER THE FINEST POSSIBLE TECHNICAL TRADE TRAINING IN RADIO, TELEVISION AND ELECTRONICS.

**You Get All This Radio  
Experimental Equipment to  
Use and Keep at Home!**

LEARN BY DOING is the basic principle of National's Shop Method Home Training. We send you standard Radio parts for an interesting series of experiments which demonstrate the fundamentals of Radio, Television and Electronics. The very essence of this training is EXPERIENCE—you get actual experience by building many different types of circuits. You build a fine, long distance MODERN SUPER-HETERODYNE RECEIVER, signal generator, low-power Radio transmitter, audio oscillator, etc. This practical work develops your knowledge of Radio step by step, makes you a practical Radio Technician.

G. I. APPROVED

**NATIONAL SCHOOLS**

LOS ANGELES 37, CALIFORNIA EST. 1905



**MAIL OPPORTUNITY COUPON FOR QUICK ACTION**

NATIONAL SCHOOLS, Dept. RC-2  
4000 South Figueroa Street, Los Angeles 37, California

Mail me FREE the two books mentioned in your ad, including a sample lesson of your course. I understand no salesman will call on me. I have checked below the plan which interests me.

NAME . . . . . AGE . . . . .

ADDRESS . . . . .

CITY . . . . . STATE . . . . .

(Include your zone number)

- I am interested in home study only.
- Send information on your Combined Home-Study and Modern Resident Shop Training.
- Veteran of World War II.



**VETERANS**

During the war, National trained enlisted men under contract with the War Department. Both the Armed Forces Institute and Marine Corps Institute used our lesson texts on a wide scale. Now, we are training veterans, both resident and home study, through the Veterans Administration. If you are a veteran of World War II—and qualified for training under the G.I. Bill of Rights, check the coupon for special information.



**GET THESE  
2  
BIG BOOKS FREE!**

# FEBRUARY • 1948

Editorial: The War on Servicemen.....by Hugo Gernsback 17  
 Radio-Electronics Monthly Review..... 18, 19

## Electronics

Constructing a Radio-Frequency Heater.....by Richard C. Kleinberger 20  
 Sunspots and Radio.....by Dr. Harlan True Stetson 24  
 Pulse Code Modulation.....by Fred Shunaman 28

## FM and Television

Radio Record Player for your FM Receiver.....by Richard H. Dorf 27  
 Designing Televisers..... 36

## Servicing

Radio Set & Service Review (Collins Model 75A-1).....by R. F. Scott, W2PWG 32  
 Scratch Suppressor..... 70

## Sound

Magnetic Recording, Part IV.....by A. C. Shaney 31

## Test Instruments

Signal Tracer is Hand-Size.....by Charles W. Carruthers 34  
 Simple Bridges for Inductance Checks.....by R. G. Young 35

## Construction

I-10 Meter Receiver.....by I. Queen, W2OUX 23  
 BC-946 as B.C. Receiver.....by Lynn G. Herbert 26

## Departments

Transatlantic News.....by Ralph W. Hallows 38  
 World-Wide Station List.....Edited by Elmer R. Fuller 40  
 The Question Box..... 42  
 New Radio-Electronic Devices..... 46  
 Radio-Electronic Circuits..... 48  
 Try This One..... 50  
 Technotes..... 56  
 New Radio-Electronic Patents.....by I. Queen 66  
 Communications..... 82  
 Book Reviews..... 87



Incorporating  
 SHORT WAVE CRAFT TELEVISION NEWS  
 RADIO & TELEVISION

### HUGO GERNSBACK

*Editor-in-Chief*

FRED SHUNAMAN, *Managing Editor*

M. HARVEY GERNSBACK,  
*Consulting Editor*

ROBERT F. SCOTT, W2PWG,  
*Technical Editor*

ANGIE PASCALE,  
*Production Manager*

I. QUEEN, W2OUX, *Editorial Associate*

ELMER FULLER, *Shortwave Editor*

G. ALIQUO, *Circulation Manager*

JOHN J. LAMSON,  
*Advertising Director*

ALFRED STERN, *Promotion Manager*

### In An Early Issue

Electronic Instrument Pickup  
 A Capacity-Operated Relay  
 De Luxe Amateur Transmitter

### On the Cover:



Dr. R. W. Sears of Bell Telephone Laboratories with the pulse modulation coding tube he developed.

*Chromatone by Alex Schomburg from photo by Warren Z. Illes.*

Member Audit Bureau of Circulations



RADCRAFT PUBLICATIONS, INC. Hugo Gernsback, President; M. Harvey Gernsback, Vice President; G. Aliquo, Secretary  
 Contents Copyright, 1948, by Radcraft Publications, Inc. Text and illustrations must not be reproduced without permission of Copyright owners.  
 RADCRAFT PUBLICATIONS, INC. • PUBLICATION OFFICE 29 Worthington Street, Springfield 3, Mass. • EDITORIAL AND ADVERTISING OFFICES 25 West Broadway, New York 7, N. Y. Telephone REctor 2-9690.  
 BRANCH ADVERTISING OFFICES: Chicago: 308 W. Washington Street, Chicago 6, Ill. Tel. Randolph 7363. Detroit: Frank Holstein, Manager, Room 402 Lexington Bldg., 2970 West Grand Blvd., Detroit 2, Mich. Telephone Madison 7026-7. Los Angeles: Ralph W. Harker, Manager, 606 South Hill St., Los Angeles 14, Calif. Tel. Yucker 1793. San Francisco: Ralph W. Harker, Manager, 582 Market St., San Francisco 4, Calif. Tel. Garfield 2481.  
 RADIO-CRAFT, February, 1948, Volume XIX, No. 5. Published Monthly on 25th of month preceding date of issue. Allow one month for change of address. When ordering a change, please furnish an address stencil impression from a recent wrapper. All communications about subscriptions should be addressed to the Circulation Manager, Radio-Craft, 25 West Broadway, New York 7, N. Y.  
 SUBSCRIPTION RATES: United States and possessions, Mexico, Central and South American countries, \$3.50 a year; \$6.00 for two years; \$8.00 for three years. Canada, \$4.00 a year; \$7.00 for two years; \$9.50 for three years. All other foreign countries, \$4.25 a year, \$7.50 for two years; \$10.25 for three years. Entered at Post Office, Springfield, Mass., as second-class matter under the Act of March 3, 1879.  
 FOREIGN AGENTS: Great Britain: Atlas Publishing and Distributing Co., Ltd., 18 Bride Lane, Fleet St., London E.C.4. Australia: McGill's Agency, 179 Elizabeth Street Melbourne. France: Brentano's, 37 Avenue de l'Opera, Paris 2e. Holland: Technisch Bureau Van Boerle, Bemelmans & Co., Heemsteedsche Dreef 124, Heemstede. Greece: International Book & News Agency, 17 Amerikis Street, Athens. So. Africa: Central News Agency, Ltd., Cor. Rissik & Commissioner Sts. Johannesburg; 112 Long Street, Capetown; 369 Smith Street, Durban, Natal. Universal Book Agency, 70 Harrison Street, Johannesburg. Middle East: Steimatzky Middle East Agency, Jaffa Road, Jerusalem. India: Susil Gupta (Distributors) Co., Amrita Bazar Patrika Lt., 14 Ananda Chatterjee Lane, Calcutta.

# TELEVISION IS GROWING!



Dr. Lee de Forest

No longer is Television just a laboratory marvel. It is rapidly spreading over the nation. Practically every radio manufacturer has Television models in production. New stations are being licensed. Television is already *big business*.

## Are You Ready?

Who will get those new high paying jobs? Who will step into key positions in a rapidly growing industry? Not inexperienced radio men. Not untrained electricians. But men who know Television and can be relied upon to operate and maintain expensive equipment!

## American Television—A Great Training Institution!

American Television has pioneered in Television research. Its directors have made fundamental contributions to the industry. Dr. Lee de Forest, our Director of Research and Training, is known throughout the civilized world as the "Father of Radio" through his invention of the radio tube. U. A. Sanabria, President and founder of American Television, Inc. invented the Interlace Scanning System which is now the standard of all Television. Most recently, a revolutionary new circuit which corrects a common television defect known as "ghost images" has been developed by J. M. Sanabria, head of American Television's Manufacturing Division.

### Most Elaborate Training Laboratories

Every modern type of equipment obtainable has been installed for instruction purposes in what we believe to be the most extensive and elaborate Television training facilities in the world. You will find complete operating studios with the new sensitive cameras and their associated equipment. A corps of highly qualified instructors will guide your study.



## Start Learning TELEVISION at Home—FREE!

Prepare yourself for the endless opportunities in Television the new "American" way. Now, for the first time, you may discover in advance of entering school, just how your abilities fit into Television. If you qualify under the simple rules, you will be given a complete preliminary home study Television course absolutely free and without obligation.

Your success with the course will not only help you to decide for yourself what phase of Television you like best but will also aid us in qualifying you for residence training.

We prefer that all new resident students take this free course as it provides excellent preparation for residence study. However, there is no obligation on your part to enroll for residence training when you complete the home study course.

We urge you to take advantage of this splendid opportunity at once. Just write your name and address on a penny postcard and say: "I am interested in your free Television Course". Do it today! This offer is necessarily limited.

Approved for Veteran Training



# American Television, Inc.

5050 BROADWAY

CHICAGO 40, ILLINOIS

# Free

## CONCORD RADIO CATALOG



**LOWEST PRICES on Everything in  
 RADIO • TELEVISION • RADAR  
 ELECTRONIC EQUIPMENT**

- Thousands of items—parts, supplies and equipment—for every Radio and Electronic need.
- Special Bargains—hundreds of money-saving values in top quality Radio Parts.
- Immediate delivery from big complete stocks at Chicago and Atlanta.

MAIL COUPON FOR FREE COPY

# CONCORD

RADIO CORPORATION

**CHICAGO 7**                      **ATLANTA 3**  
 901 W. Jackson Blvd.              265 Peachtree St.  
 Downtown Chicago Branch: 229 W. Madison St.  
 Lafayette Radio Corp.

*A Few of the Thousands  
of Great Money-Saving  
Buys in this 160-Page  
Radio Catalog!*



**Filter Choke**  
 30 Henry, 50 Ma.  
 Low Cost Per Henry

450 ohms D.C. resistance. Unshielded, strap type mounting. Ideal for replacement and experimental uses. Size: 2 1/2 x 1 1/2 x 2 1/4". Shpg. wt., 2 lbs. **59c**  
 X183 .....



**Crystal Pickup**

Quality crystal pickup mounted in arm for 10" and 12" records. Mounting included. Requires 1/2" hole. Shielded lead and cartridge case. Aluminum die cast arm finished in smooth dark brown. With semi-permanent needle. **\$159**  
 X143 .....

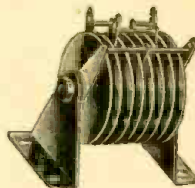

**Full Wave Selenium Rectifier**

BL 8-plate selenium full wave rectifier with bracket mounting. 12 VDC output with 18 VAC input, 8 VDC output with 12 VAC input both at 2 amperes drain. Measures 3" long, 1 1/2" wide, 2 1/2" high. Shpg. wt. 2 lbs. **89c**  
 583965 .....



**Crescent Record Changer**

Single posted changer plays 10 twelve-inch records or 12 ten-inch records. Rejects any record desired. Can be operated manually. Tone arm can be moved at any time without damage. Mounted in brown metal case with ventilating louvers, and hole cut for mounting speaker. Changer is finished in two tone brown. **\$1695**  
 589573 .....



**Even-Speed Phono Motor**

Model 80. Rim-drive phono motor. 9" turntable. Constant speed (78 r.p.m.) self-starting, forced draft air-cooled. For 10" and 12" records. 110 V. 60 cycles only. Wt. 4 lbs. **\$769**  
 X182 .....



**50/30 MFD. 150 WVDC Electrolytic Condenser**

583235  
 See this and similar **29c** bargains on page 52 of Concord's newest catalog.



**10 MMFD Double Spaced Air Padding Condenser**

Same size as regular air padding condensers, but with twice the spacing between plates, and with 1/4" shaft 1 1/2" long. Mounts by means of two threaded studs. **12c**  
 583508 .....

**HERE'S A REAL BARGAIN!**

A Type 211 Transmitting tube for only **39c**  
 5B603 .....

Concord Radio Corporation, Dept. RC-28  
 901 W. Jackson Blvd., Chicago 7, Ill.

Yes, rush FREE COPY of the comprehensive new Concord Radio Catalog.

Name .....

Address .....

City ..... State .....



**Where Will YOU Be  
5 Years from Now?**

**RADIO-ELECTRONICS  
SERVICING Will  
Advance Unbelievably  
During the Next Decade!**

**Will You** be a Trained Radio  
Electronics Technician holding a highly-skilled, well-paid position? **?**

**OR**

**Will You** be just another serviceman who "muffed" his BIG opportunity back in '47? **?**

Foresighted radio servicemen are looking ahead to the future. A future that has unlimited opportunities and real profits for those who have the "Know-How" to SERVICE television, FM, industrial electronic equipment, and the many other new radio developments.

Join the many professional servicemen who are studying at home, the new developments, the new techniques, with CREI . . . protecting their future jobs, their businesses by acquiring the new "Know-How," NOW!

CREI'S reputation for some study training has been proved over 19 years. Important new developments have been included in our present course. Trained instructors give you personalized attention and guidance all the way.

Find out for yourself how CREI can help you to greater security and prosperity. Send in the coupon now! Actually see what CREI has to offer.

**VETERANS! CREI TRAINING AVAILABLE UNDER THE "G. I." BILL!**

**Capitol Radio Engineering Institute**

*An Accredited Technical Institute*

DEPT. RC-2, 16TH AND PARK ROAD, N. W., WASHINGTON 10, D. C.

Branch Offices: New York (7): 170 Broadway • San Francisco (2): 760 Market St.

**SAMPLE LESSON  
FREE**

Now, see for yourself! Mail the coupon for free sample lesson and see how simple it is to study at home and improve your ability the CREI way.

"ELECTRON PHYSICS AND ELECTRON THEORY"—This interesting lesson from the Radio-Electronics course discusses modern theories of the composition of matter, including *atomic energy*, and their relation to present-day radio and electronics.

"PICK-UP TUBES—ICONOSCOPE AND IMAGE DISSECTOR TUBES"—An informative lesson from the Television course. These are the fundamental pick-up tubes of the television camera. It precedes the study of the Orthicon and the Image Orthicon.

**MAIL COUPON FOR FREE  
BOOKLET & SAMPLE LESSON**



**CAPITOL RADIO ENGINEERING INSTITUTE**

16th & Park Rd., N.W., Dpt. RC-2, Washington 10, D. C.

Mail me ONE FREE sample lesson and your 24-page booklet, "CREI Training for Your Better Job in Radio Electronics". I am attaching a brief resume of my radio experience, education and present position.

Check One  PRACTICAL RADIO-ELECTRONICS  
Course:  PRACTICAL TELEVISION

NAME \_\_\_\_\_

STREET \_\_\_\_\_

CITY \_\_\_\_\_ ZONE \_\_\_\_\_ STATE \_\_\_\_\_

I am entitled to training under the "G. I." BILL.



# ESSE Specials!

Do not fail to closely examine this list of bargains. We believe that every item listed below is a sensational value that soon can never be repeated. All equipment advertised herein is unconditionally guaranteed to the customer's satisfaction to this extent: Return any item advertised within five days after delivery for full refund except transportation charges (both ways).

Below are listed surplus radio and electronic supplies that are too numerous to picture. Every ham and operator is familiar with these items. See our previous ads for pictures and more complete descriptions.

## RECTIFIER RA-63-A

Battery charger or rectifier, or power supply units. 110 V. 60 cy. input; 12 V. 8 amp. output. Brand new .... **\$19.75**

## ARB (CRV-46151) AIRCRAFT RADIO RECEIVER

6 tube, 4 band, superheterodyne rec. with built-in dynamotor. Designed for reception of MCW, (tone or voice) or CW within the frequency range 195 Kc. to 9.05 Mc. We bought a carload of these in order to sell them at this price ..... **\$19.50**

## BC-221 FREQUENCY METER

Covers 125-20,000 Kc. Battery or 110 V. AC, vibra-packed operated. A beautiful instrument ..... **\$49.95**

## T-17-B CARBON MICROPHONES

Hand mike, Brand new ..... **\$1.00**

## HS-33 HEADPHONES

600 ohm. (Used) ..... **.75**

## HEADPHONE EXT. CORD

..... **.50**

## PE-103 DYNAMOTOR, New

..... **8.95**

## IF AMPLIFIER STRIP

19 Mc. containing 5 WE 7-17A tubes ..... **\$3.95**

## INTERVALOMETER

Electronic timing device. Was used for releasing bombs at intervals. Ideal for dark-room timer, model train controller. (Contains relays, switches, pilot light, resistors, knobs, etc.) ..... **\$2.25**

## WILLARD LEAD ACID CELLS

(Brand New)

2 V. (dry-chgd.) ..... **\$1.00**  
 6 V. (dry-chgd.) ..... **\$3.00**  
 6 V. (in metal carrying case) (dry chgd.) ..... **\$4.00**  
 (add electrolyte specific gravity 1.265—drug-store).

## LANDING LIGHTS—AIRCRAFT

24 V. retractable, 600 watts ..... **\$3.95**

## BC-348 COMMUNICATIONS REC.

The finest of all surplus receivers ..... **\$69.50**

## BC-348 110 V. Power Supply

..... **8.95**

## SCR-625 MINE DETECTOR

(Brand New). The most sensitive mine detector on the surplus market. For miners, treasure hunters, plumbers, etc. .... **\$79.50**

## AN/PRS-1 MINE DETECTOR

(Brand New). A very dependable detector. Only ..... **\$14.95**

## TURBO AMPLIFIERS

Use for parts or small phono amplifier, shipped complete with the following tubes: 2—7C5's, 1—7Y4, 1—7F7. Our greatest bargain, ea. .... **\$1.65**

## BC-375 GE MOPA XMTR.

The most famous of all surplus transmitters. Was used by the Army bombers and ground stations during the War. Frequency range is covered by means of plug-in tuning units as shown below. Each tuning unit has its own oscillator and power amplifier coils and condensers, and antenna tuning circuits all designed to operate at top efficiency within its particular frequency range. Transmitter and accessories are finished in black crackle, and the milliammeter, voltmeter, and RF ammeter are mounted on the front panel. FREQUENCY RANGE: 200-500 Kc. and 1500-12,500 Kc. (Will operate on 10 and 20 meter band with slight modification.) OSCILLATOR: self-excited, thermo-compensated, and hand calibrated. POWER AMPLIFIER: neutralized class "C" stage, using 211 tube, and equipped with antenna coupling circuit which matches practically any length antenna. MODULATOR: Class "B"—uses two 211 tubes. POWER SUPPLY: Dynamotor which furnishes 1000 V. at 350 Ma. Conversion instructions and diagram for 110 V. AC furnished upon request for \$1.00.

PRICES: As follows—

Transmitter only ..... **\$19.50**  
 Tuning units TU-5B, TU-6B, TU-7B, TU-8B, TU-9B, TU-10B, TU-26B, choice ..... **\$3.75**  
 Dynamotor PE-73C ..... **\$4.95**  
 Antenna tuning unit (BC-306A) ..... **\$4.95**

## BC-357 MARKER BEACON RECEIVER

Ideal for controlling remote circuits and model aircraft, boats, etc. Operates about 75 Mc. Signal easily altered to 2-meter band. Tubes used and included: 12C8, and 12SQ7. Also sensitive relay. Circuit diagram inside case. Size, 5 3/8 x 3 3/8 x 5 1/4". For 24V DC operation ..... **\$2.95**

## RADIO ALTIMETER INDICATOR 1-152-AM

Includes 3DP1, 2X2, and 3 type 6AG5 tubes. Powered by 110 V 400 cy. .... **\$8.75**

## T-39/APQ-9 RADAR TRANSMITTER

Contains many excellent parts for the VHF experimenter such as a cavity oscillator using 2—RCA 8012 tubes rated at full output to 500 Mc. Tubes are forced air-cooled by 24 V. DC motor, which is easily converted for 110 V. AC operation. Other valuable parts such as a pair of 807's, 2—6AC7's, 1—931, and 1—6AG7 tubes, ceramic switch, potentiometers gears, revolution counter, etc. .... **\$12.50**

## APN-1 RADIO ALTIMETER

A complete 460 Mc. radio rec. and trans. which can be converted for ham or commercial use. Tubes used and included: 4—12SH7, 3—12SJ7, 2—6H6, 1—VR150, 2—955, 2—9004. Other components such as relays, 24 V. dynamotor, transformers, pots, condensers, etc., make this a buy on which you cannot go wrong. Complete in aluminum case 18 x 7 x 7 1/4" ..... **\$8.95**

## INTERPHONE AMPLIFIER

We've sold thousands of these. Every ham and experimenter could use several at our low price. Type AM-26/AIC with 28 V. DC dynamotor. Contains 2—12A6, and 2—12J7 tubes. Easily converted for phonograph or inter-communication amplifier. A steal ..... **\$1.75**

## BC-966-A IFF

Approximately 2-meter operation, 14 tube, 350 V. DC dynamotor, 12 V. DC input. Contains voltage regulators and many other fine parts. Worth much more than our price for parts ..... **\$4.75**

## DETROLA AIRCRAFT RECEIVER

If you want a good 28V. DC operated 200-400 Kc. aircraft receiver—just don't pass up this bargain. A few left at ea... **\$4.75**



**IF TRANSFORMER**19.2 Mc. Ea. **\$.20****TELRAD 18-A FREQ. STANDARD**

Checks signals in the range of 100 Kc. to 45 Mc. with a high degree of accuracy. Self-contained power supply for 110, 130, 150, 220, and 250 V. 25-60 cy. AC. Complete with tubes, dual crystal, and instruction book. One of the best buys on the surplus market today. Brand new. **\$24.95**

**BEAM ROTATING MOTORS**

Look at our other ads for more complete descriptions. Fellows, we've sold hundreds of these. Every ham shack cannot afford to be without one.

24-28 V. DC motor **\$9.95**24-28 V. motor with beam mounting plates attached. **\$14.50**Transformer to operate beam motor on 110 V. (New) **\$4.95**

Selsyn indicators for beam rotating motor (operates from 15-25 V. 60 cy. AC supply.) Choice of 5" or 3" model. Ea. **\$2.85**

**BL SELENIUM RECTIFIER**(New) **\$1.25****RADIO SET SCR-510**(New) **\$49.75****R-89-ARN5 GLIDE PATH REC.**

326-335 Mc on any of 3 pre-determined crystal controlled frequencies. Contains 11 tubes, 6 relays, and other valuable parts. For 24 V. DC operation. Size, 13<sup>3</sup>/<sub>4</sub>x5<sup>1</sup>/<sub>4</sub>x6<sup>3</sup>/<sub>8</sub>". **\$7.95**

**AIRCRAFT SUPPLIES**

These instruments have all been tested for accuracy.

Sensitive Altimeters **9.00**Gyro-horizons **7.50**Magnetic Compasses **6.00**MN-26 Radio Compass. (Brand new) **69.50**SCR-269F Radio Compass. (Brand new) **69.50**

Astro Compass.

These are beautiful instruments that should sell on the regular market for many, many times our price. They have various uses including those of the yachtsman as well as the airman. If you desire, send for more complete descriptive literature. **\$11.50**

**C-1 AUTO PILOT AMPLIFIER**

Were used to control operation of Servo-units, causing them to move the control surface of airplane in one direction or the other in response to signals received. The complete amplifier includes one rect. 7Y4, 3-7F7's for amplification and control, 3-7N7's for signal discrimination, 1 power transformer, 6 relays, 4 control pots, chokes, condensers, etc. Convert for use on radio controlled models, doors, etc. Operates from 24 V. DC. Size 9<sup>1</sup>/<sub>4</sub>x6<sup>1</sup>/<sub>4</sub>x7<sup>5</sup>/<sub>8</sub>". Complete **\$3.95**

**BC-733D LOCALIZER REC.**

A part of aircraft blind landing equipment. Operates on any one of its 6 pre-determined crystal controlled frequencies in the range of 108-120 Mc. Contains 10 tubes—3 of which are W.E. 717-A's—and crystals. Ideal receiver for conversion to 144 Mc. ham band or mobile telephone bands. For 24 V. DC operation. Size, 14<sup>1</sup>/<sub>2</sub>x7x4<sup>5</sup>/<sub>8</sub>". Complete with dynamotor. **\$4.95**

**THROAT MIKES**7 for **\$1.00****NAVY HOSPITAL TENTS**

These large, brand new, fire-resistant, fungus-proof, water-proof, heavy canvas tents are of the finest grade canvas with tie-down ropes, in canvas carrying bag. Wgt. 365 lbs. Size, 16' width, 50' long, 12' apex, 4' sidewall. We have but 20 of these left and must sell them immediately. Can be used to house automobiles, machinery, side-shows, or various purposes. Our sacrifice price. **\$185.00**

**LIFE RAFTS**

Off-season Sale. Large size rubber floats, ideal for fishing and boating. Sold in an "as is" condition—some need minor repairs and inflation valve inserted. Ea. **\$12.50**

**SCR-274N COMMAND SET COMPONENTS (ARC-5)**

Modulator with dynamotor **5.75**  
 Rec. 190-550 Kc. **5.75**  
 Trans. 4-5.3 Mc. **5.75**  
 Trans. 3-4 Mc. **5.75**  
 Trans. 5.3-7 Mc. **5.75**

**COLLINS AN/ART-13 XMTR.**

A compact, light-weight, modern, high-powered transmitter. Frequency range 2-18-1 Mc. on any of its 11 auto-tune crystal controlled or master oscillator channels. Dec., 1947, *Radio News* gives conversion data for converting 24 V. DC operation to 110 V. AC. These are in exceptionally fine condition, tested in our labs. Wgt., 67 lbs. (Dynamotor included) **\$134.50**

All equipment advertised herein is unconditionally guaranteed to the customer's satisfaction to this extent: Return any item advertised within five days after delivery for full refund except transportation charges (both ways).



**Radio Co**

40-42 W. South St.  
 Indianapolis 4, Ind.

Unless Otherwise Stated, All of This Equipment Is Sold As Used  
**CASH REQUIRED**  
**WITH ALL ORDERS**  
 Orders Shipped F.O.B. Collect



*"It's the one that  
REALLY WORKS"*

*Reports Pilzer Twigg*

You all remember Pilzer from way back before the war. He repairs radios at the Acme Radio Emporium. After field-testing advance samples of the new Sprague TM, Mr. Twigg reports:

"Up to now I couldn't keep a tubular in the auto radio in my Model T long enough to bother with puttin' one in. Now motoring is fun again. The radio coos like a baby. Sprague TM's are the only ones that really work!"



## The first truly practical all-purpose HIGH-TEMPERATURE MOLDED paper tubulars—New type TM

- Highly heat resistant
- Moisture resistant
- Non-inflammable
- Conservatively rated
- Small in size
- Mechanically rugged
- Completely insulated

After more than four years of intensive research, plus one of the largest retooling programs in its history, Sprague announces a complete line of high-temperature molded paper tubular capacitors that offer far-reaching advantages for a long list of products ranging from home or auto radios and electrical appliances to military equipment. These new molded types will be known as "TM" units. Basically, because of its completely new method of construction, this Sprague TM unit is so far ahead of anything now available, it should

have the same effect on the paper tubular capacitor business that bakelite molded resistors had in the resistor field years ago.

The unique high-temperature molded construction of these new capacitors assures maximum dependability even under extremes of heat, humidity, and physical stress. Thus the new TM types have virtually universal application in modern equipment. **YOU CAN STOCK ONE BRAND FOR ALL REQUIREMENTS—SPRAGUE TM'S!**

*Reach for a Sprague and know you're right!*

CAPACITORS

# SPRAGUE

\*KOOLOHM  
RESISTORS

\*T.M. Reg.  
U.S. Pat. Off.

SPRAGUE PRODUCTS COMPANY, North Adams, Mass.

JOBGING AND DISTRIBUTING ORGANIZATION FOR THE PRODUCTS OF THE SPRAGUE ELECTRIC COMPANY)

# THE WAR ON SERVICEMEN

## *New Pressure Continues Against Radio Servicemen . . .*

By HUGO GERNSBACK

**H**ERE is a little story which will be of interest to every reader of this magazine. I give it to you the way it was related to me:

Not so long ago a certain household called up the Service Department of the Telephone Company complaining that very frequently their phone went dead. Whenever this happened no outgoing calls could be made nor could incoming calls be received.

The woman of the household reported this a number of times. The 'phone company promptly sent over a serviceman. He took the telephone instrument apart, checked the ringer box, but could find nothing wrong.

It appears that the trouble occurred only in the evening—never during the day. Several other servicemen investigated the case, but the subscriber continued to complain until the case began to be a nuisance at the central 'phone office.

The record indicated that no less than four servicemen had gone to the subscriber, that everything had been checked carefully, yet the 'phone continued to go dead in the evening.

Finally one of the best troubleshooters was assigned to the case. After he had studied the complaint records he decided to make his call in the evening to ascertain the cause of the trouble. At the subscriber's home instead of looking at the 'phone instrument itself—which he knew was O.K. because the instrument had been checked several times already—he proceeded to make a careful inspection of the wiring.

He traced the line from the incoming house shaft through the hall to the apartment entrance of the subscriber, then followed each foot of wire through the hall and living room. Next he noted that the wire went into a room the door of which was closed. He asked the lady of the household if he could enter the room. She assented providing he would make no noise, because her husband was asleep on the couch. The telephone man promised this and noiselessly kept on tracing the wire. Inside the den the wire ran alongside the door frame. About five feet from the floor the troubleshooter was amazed to find a pin which had been stuck into the phone line, thereby neatly shortcircuiting the wires! He removed the pin, tiptoed out of the room, went to the phone, dialed and got the operator.

He then turned to the lady of the house and smilingly told her that the cause of the trouble had finally been located: Someone in the household, he emphasized meaningly, evidently had a reason for shortcircuiting the line every night at a certain time. He then departed.

Verbal fireworks immediately flared. The outraged wife promptly awoke her husband and asked the reason for shortcircuiting the phone at night. The explanation was simple:

The lord and master—a harried broker—had a number of children and there were always dozens of calls

when he took his nap. The 'phone bell next to his den kept ringing practically uninterruptedly with the family clomping back and forward noisily through the hall whenever the phone rang. So he thought up the simple device of shortcircuiting the line and getting some quiet into the household—and a reduced phone bill. This solved the problem until the "gimmick" was discovered by the 'phone engineer.

Why do I tell this story? For a very simple reason. When it comes to servicing any technical device—be it a telephone, an automobile, or a radio—a serviceman goes through a certain well defined procedure. When failure occurs the technical serviceman will look for certain things first. That is his instinctive routine.

When, however, someone maliciously gimmicks a device—be it a 'phone, an automobile, or a radio—then we have a horse of a different spectrum.

Very often an investigator (who should know better) when he wishes to test servicemen—"fixes" a utility in a devious manner—which to him is obvious. But since that is not a normal failure of the device, no matter how intelligent the serviceman is he will not look for a "planted" gimmick, but goes on looking for a normal failure.

Frequently such a dodge is used for publicity articles in order to show up the various servicing trades. This is an old trick and has been done for generations. Every once in a while it turns up to the discomfiture of some particular servicing industry. The latest one occurred in New York recently when Lyle Van made a survey for Station WOR, the key station of the Mutual Network. On its face the survey indicated—according to the *New York Post*—that many radio repairmen are still chiselers.

Says the *Post*, and we quote verbatim:

It seems WOR sent out a \$60 battery-operated portable Jefferson-Travis set, in perfect condition *except for a short circuit in plain view in back of the set.* (The italics are ours.—R.C.) This could have been repaired in less than a minute with a screwdriver.

So what happened? The set was brought by Irwin Rosten, *Radio Daily* reporter, to two dozen repair shops. Not a single shop would give an estimate of charges while Rosten waited. Every shop insisted the set needed a thorough examination lasting hours, so, Rosten had to leave the set. Each shop claimed the set needed new condensers, or transformers, or oscillators, tubes, wiring, alignment, etc. Charges ranged from \$9.50 to \$15. Not a single shop told the truth: that the set had a short circuit in the antenna loop.

Not only that, but the trips to the 24 shops resulted in the set being ruined, thanks to tampering by the repairmen.

I note that a Radio Serviceman's Association of New York has just been formed. It hopes to investigate complaints by customers. Recently, City Councilman Stanley Isaacs proposed licensing of (Continued on page 68)

**STRATOVISION** will take to the air again early in 1948, Westinghouse engineers announced last month. In the second stage of the Stratovision experiments television programs will be broadcast from planes flying at an altitude of 30,000 feet.

Although Stratovision was proposed some years ago (it was described in **RADIO-CRAFT**, October, 1945) further experiments have been carried out practically without publicity. The 1948 experiments, however, will be on Television Channel 6 and will be participated in by thousands of television receiver owners.

**ISOTOPES**, used for various types of study and to cure disease, will from now on supply the world with its standard of length, the Bureau of Standards revealed last month. The new unit is the length of a wave of green radiation transmitted by mercury 198, an isotope transmuted from gold by neutron bombardment.

Legally the standard of length for most of the world is the distance between 2 lines on a platinum-iridium "metre" bar at the International Bureau of Weights and Measures in France. Two lines traced on a bar are a rather crude instrumentality for precise measurements, and the red line of cadmium has been used for many years wherever extreme precision has been needed. However, the cadmium standard also has serious disadvantages. First, there is a fine structure in the red radiation which prevents the line from being as sharp as desirable and thus limits the possible precision. Second, the cadmium standard requires excitation in a furnace, which entails unwanted broadening of the spectral line because of relatively high temperature.

The green line of mercury 198 has none of the disadvantages of either the meter bar or the red line of cadmium.

# RADIO-ELECTRONICS

The normal human eye is far more sensitive to green than to red, an important consideration in visual adjustment of the interferometer with which lengths are measured and compared. All other characteristics desirable in a light wave standard—such as ability to be reproduced, absolute sharpness of the wavelength, intensity of the spectral line, life and ease of maintenance—are possessed to a greater extent by mercury 198.

**INTERFERENCE** to British television programs from American FM broadcasts has become so severe that changes in American program schedules have been made, it was revealed last month. Commander E. F. McDonald, president of the Zenith Radio Corporation, asked for and received permission from the FCC to change temporarily the broadcasting hours of his station WEFM to avoid interference with the London television station between the hours of 3:00 and 4:00 p.m. Greenwich Time.

The interference, first noticed early this week, is caused by long-range skip transmissions from the Zenith 45.1-mc FM transmitter. McDonald suggested that it is a temporary condition brought about by sunspot activity, now at the highest point ever recorded, and will not recur again as a serious problem at such extreme distances for 11 years, when sunspots will again reach maximum.

Effective immediately and continuing until the sunspot activity wanes in a matter of days or weeks, WEFM will begin broadcasting at 10:00 a.m. Chicago time (4:00 p.m. London time), and continuing until midnight.

**LARGE-SCREEN** television by a "double-take" method was demonstrated at the recent annual "clinic" of the Television Broadcasters Association. A moving-picture camera photographed the images on the screen of a standard television receiver, and after a development process which took only 66 seconds, the film was projected with regular moving-picture equipment. The resulting pictures were clear.

Engineers of the Eastman Kodak Co. read to the meeting a paper describing the methods by which development time was reduced to 66 seconds. Inclusion of sound, they reported, was the important difference between this and other rapid-development methods.

**TELEVISION** may be a "shock absorber" for the national economy four times as great as radio was after the first World War, Frank Mullen, executive vice-president of the National Broadcasting Co. stated last month.

While radio now has an annual turnover of more than \$1,500,000,000, he expects that television will account for more than \$6,000,000,000 annually, with a tremendous cushioning effect on employment and business as a whole.

**RADIO SERVICEMEN** were defended last month by Robert W. Damrach, production director of WEHR, Buffalo, rebutting statements made by a New York reporter who checked several New York service shops with a radio which had been "gimmicked" by shorting its loop antenna (see Editorial, page 17).

The radio serviceman, Damrach pointed out, would first check voltages in the set. Finding everything normal, next step might be to test the tubes. The particular "gimmick" which was introduced into the set was a shorted antenna, something which would be exceedingly rare in bona-fide repair work, and a serviceman would be likely to spend a great deal of time before finding it. A fair charge for the service might be an hour's labor charge which would probably run about \$2.50, Mr. Damrach believed.

**THE EDISON MEDAL** for 1947 has been awarded to Dr. Joseph Slepian, the American Institute of Electrical Engineers announced last month. Dr. Slepian, who is associate director of the Westinghouse Research Laboratories, was given the medal "for his practical and theoretical contributions to power systems through circuit analysis, arc control and current interruption" He is the inventor of the ignitron, highest-powered of all electronic tubes, and pioneered in the development of circuit breakers and lightning arrestors.

Last year's recipient of the Edison Medal was Dr. Lee de Forest.

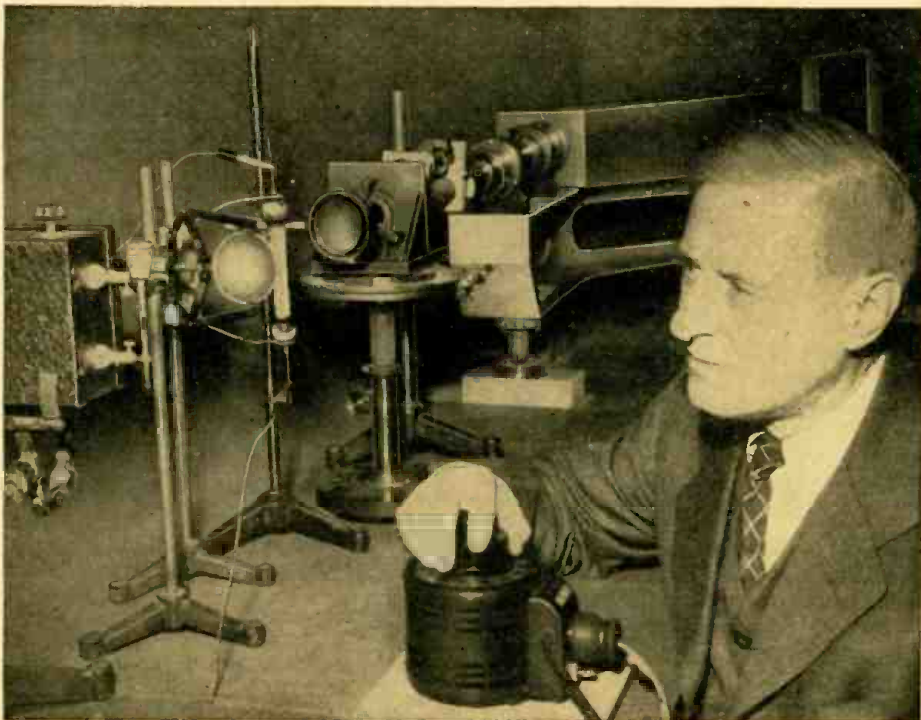

Dr. Wm. F. Meggers adjusts equipment for mercury 198 and cadmium wavelength comparison.

# MONTHLY REVIEW

**RADAR REFLECTIONS** from the apparently empty air at heights between 900 and 5,000 feet have been detected with 1.25-centimeter radar equipment at various times for the past 3 years, it was revealed last month by Herbert B. Brooks, William B. Gould and Raymond Wexler of Evans Signal Laboratory, United States Signal Corps. The inexplicable reflections have been termed "angels" by radar operators.

Angels appear to be more common in summer than winter, the Signal Corps engineers report, but have been reported in all seasons and weather conditions.

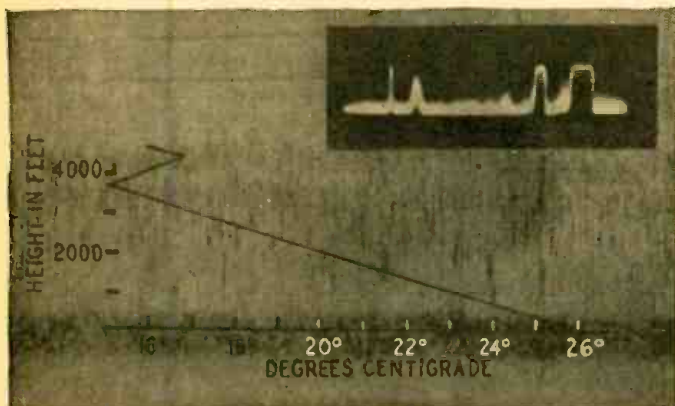

The two belts of angels are seen just below the 4,000-foot level. The insert shows how they appear on the cathode-ray tube screen.

As a means of studying the reflections, Mr. H. B. Brooks of Evans Signal Laboratory devised a means of recording the video signals from a radar receiver on a modified facsimile receiver, obtaining a vertical cross section of the atmosphere (time vs altitude) as a situation passes through the radar beam. Prior to these recordings it had been assumed that angels always appeared at random altitudes from very close to the ground up to perhaps 9000 feet. The recordings revealed that on certain days a large percentage of angels appeared to stratify at definite altitudes.

An analysis of the records of angels made on 7 days between 5 August and 4 September, 1947, by Mr. R. Wexler of Evans Signal Laboratory, indicates that on 4 days they occurred in double layers with scattered reflections between and below the layers. On 2 of these 4 days there were irregular intervals during which only one layer was evident. On the remaining 3 days only scattered angels were observed, with no concentration at any particular level.

On the 4 days during which double strata were observed, radiosonde flights at Belmar and Lakehurst (New Jersey) revealed atmospheric inversions, the base and top of which roughly agreed with the levels at which the two layers were observed. Typical is the Lakehurst sounding of 5 August, 1947, which shows an inversion based at 3800 feet, top at 4700 feet (see figure). On approx-

imately the same scale is shown the record of the reflections. The broad blackened base is the main pulse about 900 feet in width. Time goes from right to left beginning at 14:22 EST, ending 14:35 EST. Between 900 feet and 3200 feet are scattered angels spaced more or less at random. The 2 layers exist between 3200 and 3900 feet and between 4100 and 4800 feet. Between the two layers, coincident with the inversion, reflections are few in number and randomly spaced. The layer appears, therefore, to be located just above and just below the temperature inversion.

Two theories are offered concerning angels: first, that they are reflections from dielectric discontinuities in the atmosphere; second, angels are reflections from dust specks in the air.

For the detection of dielectric discontinuities in the atmosphere to a maximum range of 9000 yards, it may be shown theoretically that a discontinuity of 0.1 millibar in vapor pressure or

0.30 degrees centigrade in temperature could be detected by the 1.25 cm radar. Such a discontinuity would have to take place over distances small compared to

the wavelength. It is not known whether or not such discontinuities occur in the open atmosphere over distances of less than 1 cm. Sharp temperature or moisture discontinuities occurring over normal distances of 50 or more meters theoretically cannot be detected by the radar.

It appears improbable that the concentration and size of dust particles theoretically required for detection by radar would be normally present in the atmosphere.

**JOHN V. L. HOGAN**, one of America's first radio inventors, was presented the Armstrong Medal of the Radio Club of America at its 1947 annual dinner meeting. Mr. Hogan was honored as the inventor of the rectifier heterodyne receiving system, continuous-process facsimile, and single-control tuning. His record as a pioneer of high-fidelity and founder of the country's first high-fidelity station, which became WQXR, was also cited.

**INFRA-RED LIGHT** was used as a means of newspaper communication for the first time last month when a Chicago reporter used "black-light" communications equipment to send a story to his city editor.

The reporter, Larry Wolters, who is the radio editor of his paper, used the "talking lamp" first developed during the last war by Westinghouse engineers, and described in *RADIO-CRAFT*, October, 1946.

The "lamp" is a special caesium-vapor tube capable of following audio modulation with efficiencies approaching 100% up to at least 3,000 cycles per second.

The modulated infra-red rays were picked up by a phototube on the roof of the newspaper building, three-quarters of a mile away.



How the beam-of-black-light signal was received at the offices of the Chicago Tribune.

# Constructing a Radio-Frequency Heater

This 1-kilowatt dielectric unit is suitable for experimental use or the small laboratory

By RICHARD C. KLEINBERGER\*

**H**IGH-FREQUENCY dielectric heating as in instrument of industrial production has made tremendous strides in the past six or seven years. Much experimental work has been done and much has been written about it, so that almost everyone who is in any way involved in electronics has some familiarity with the subject. Many who may be interested in r.f. heating have done no actual experimental work because of the initial expense involved. The purpose of this article is to describe a dielectric heater having an output of 1 kilowatt that was built by the author for experimental purposes during his spare time and represents a cash outlay of about \$350. Comparable units bought commercially sell for \$1,500 to \$1,800.

Fig. 1 shows the complete circuit diagram for the unit. The r.f. portion is a straightforward Hartley circuit using an Amperex 234-R forced-air-cooled tube. Figs. 2 and 3 show 2 views of the r.f. portion and the arrangement of the various components. The resemblance between this type of equipment and a radio transmitter is marked. At the left in Fig. 2 can be seen the plate blocking condenser, oscillator tube, filament bypass condensers, and grid blocking condenser. In the center is the oscillator tank coil and vacuum condenser, and above—mounted on the panel shield—is the grid bias resistor. The variable condenser shown is part of the load-matching network, about which more will be said later. The blower for cooling the tube is mounted under the chassis and may be seen to the extreme right in Fig. 3. With the constants

shown in the circuit diagram, the oscillator will deliver power at a frequency of about 27 mc. R.f. connections are made with 3/4-inch copper strip. Braid should not be used, as the losses are high.

The main power transformer delivers 2,800 volts either side of center tap at 1 amp. This is rectified through a pair of 872-A/872 mercury-vapor rectifier tubes. No filter is used, but a bleeder resistor of 200,000 ohms is connected across the output of the rectifier. This is to insure that the plate blocking and plate bypass condensers will be discharged when the power is turned off. Transformers for the rectifier and oscillator tube filaments have the ratings indicated on the circuit diagram. The 3 transformers were built to order from specifications. All other components in the unit are standard stock items, as indicated.

\*Consulting Engineer, White Plains, N. Y.

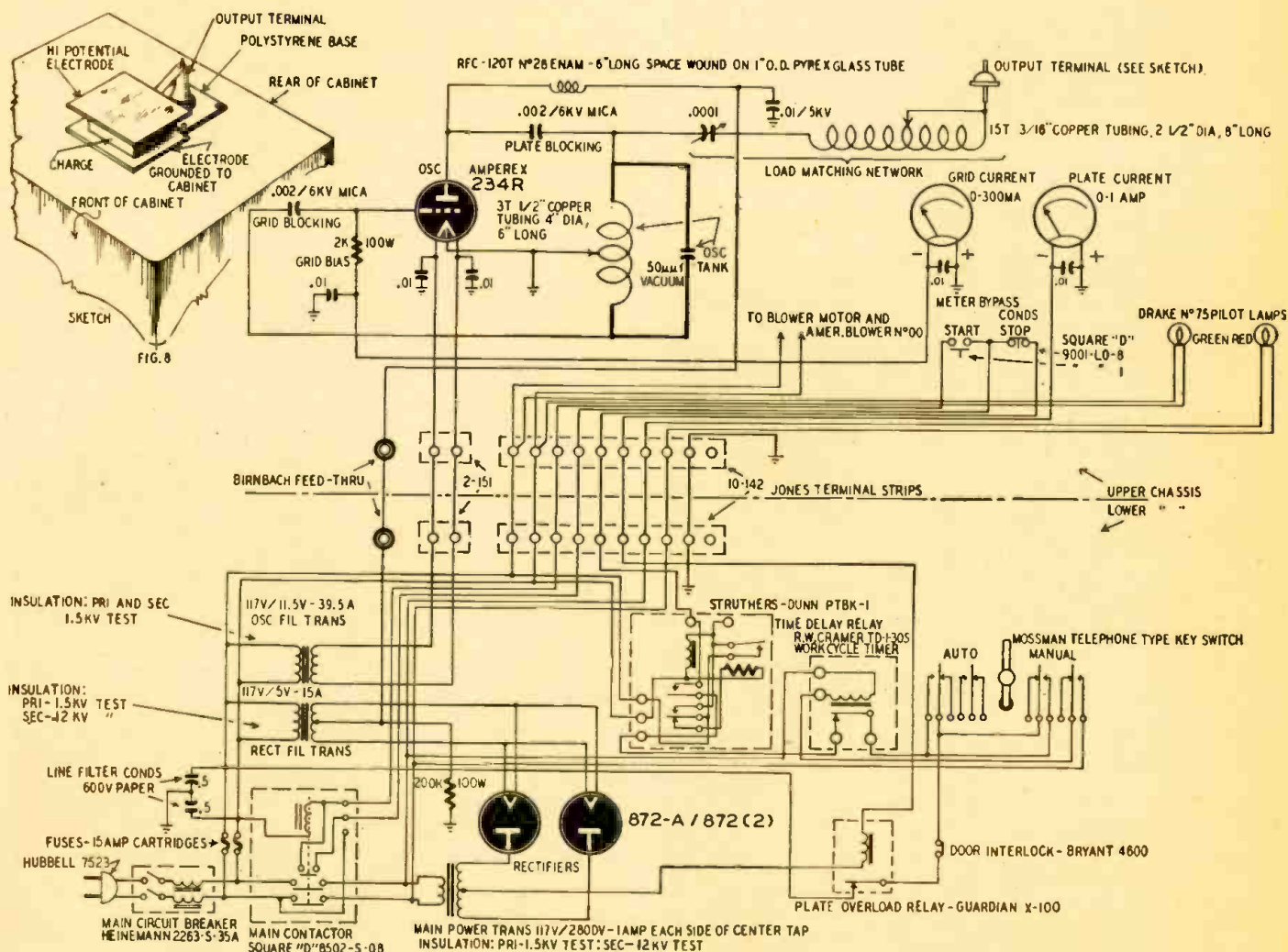

Fig. 1—The schematic. Designations of non-radio parts are included for the constructor's convenience. Transformers are made to order.

The following control items are provided: a main switch and circuit-breaker combination, main contactor, START and STOP push buttons, red and green pilot lamps, plate and grid current meters, thermal time-delay relay, work-cycle timer, plate overload relay, and AUTOMATIC-MANUAL key switch. To start, close the main circuit breaker. This causes the rectifier and oscillator tube filaments to light, the blower to operate, the green pilot lamp to light, and the thermal element of the time-delay relay to heat. After about 30 seconds the time-delay relay will operate. The purpose of the time delay is to make it impossible to apply the high voltage until after the tube filaments have had sufficient time to warm up. The next step is to push the START button. This actuates the main contactor, which causes the red pilot lamp to light and applies the high voltage to the oscillator tube. Also, if the key switch is in the AUTOMATIC position, the work-cycle timer will commence operating. If the switch is in the MANUAL position, the timer will not operate.

### Work-cycle timer

A word about the work-cycle timer is in order. This is a motor-driven, normally closed relay whose contacts are connected in series with the main contactor solenoid. It may be set to any desired time within the range of the instrument. At the end of this time the contacts open automatically, releasing the main contactor and thus shutting off the power. In many electronic heating applications it is desirable to have such automatic timing of the work cycle. When the key switch is in the MANUAL position, the timer motor is cut out so that the timer contacts remain

closed. To shut off the high voltage it is necessary to push the STOP button.

Figs. 4 and 5 are views of the power supply and control devices. The construction is conventional and requires little comment. Referring to Fig. 4, mounted on the rear of the panel may be seen (from top to bottom) the main circuit-breaker, the work-cycle timer, and the AUTOMATIC-MANUAL switch. Directly below the switch is a fuse block, with two 15-ampere cartridge fuses. These are to protect the control circuits, as may be seen on the circuit diagram. Below this are two  $\frac{1}{2}$ -uf., 600-volt paper condensers, which constitute a filter to protect the power line against radio-frequency surges. A portion of the time-delay relay can be seen on the base of the chassis just below the work-cycle timer.

The main power transformer is in the background at the rear of the chassis. Immediately adjacent are the 2 rectifier tubes. In the foreground at the left is the rectifier filament transformer, and at the right the oscillator filament transformer. In ordering this latter item it should be specified that it be of the *high-reactance* type, to limit the inrush of current when the tube filament is cold.

### General construction

Figs. 6 and 7 are front and rear views of the assembled unit. The resemblance to an amateur radio transmitter is very striking; in fact amateur components were used wherever possible. The cabinet is a Par-Metal No. DL-3513 having a panel space of 35 x 19 inches, set in a No. RT-410 roller truck. The lower chassis contains the power supply and the control devices. The upper chassis is the r.f. portion of the unit. Both chassis are 17 x 13 x 4-inch cadmium-plated steel. Both front panels are 17 $\frac{1}{2}$  x 19



Fig. 2—Radio-frequency section, rear view.

inches, black wrinkle finish. Each chassis is attached to its respective panel by means of 2 No. SB-713 steel mounting brackets. The cabinet as supplied had a door on the top. This was not desirable, so holes were drilled and brass straps fashioned and attached to the inside of the cabinet so that the door could not be opened. A square hole, 3 $\frac{1}{4}$  x 3 $\frac{1}{4}$  inches, was cut in the center rear of the cabinet top, and a piece of polystyrene of 4 x 4 x  $\frac{3}{8}$  inches mounted over it. Through the center of this was cut a hole to accommodate the large Birnbach feed-through shown in the photographs. This is the output terminal.

The ham will find himself quite familiar with the power supply and oscillator circuits. The very necessary relays and controls are the only parts of the equipment with which he has not had experience, but these features involve no technical problems.

Referring to Fig. 6, the components shown on the panels are as follows:  
(Continued on following page)



Fig. 3, left—Another view of the r.f. portion of the dielectric heater.

Fig. 4, below—The power supply section, drawn out of the lower part of its metal case. Components are identified in the text.

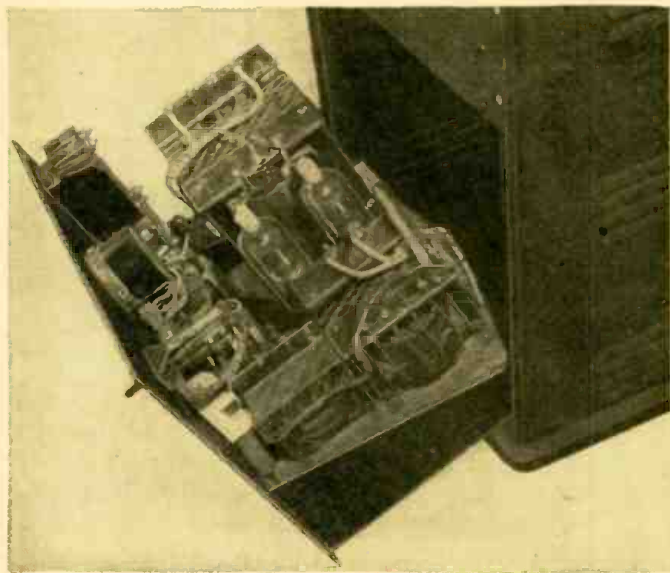

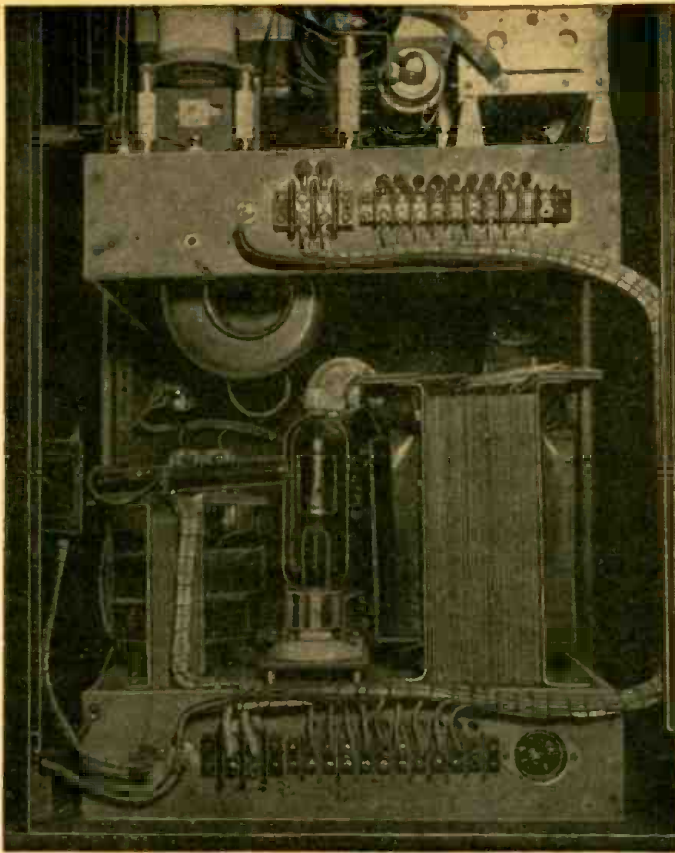

Fig. 5—Power transformer and blower are well shown in this view.

From the left at the top, the green indicator light, the start button, stop button, and red indicator light. In the next row are the grid and plate current meters. In the center of the panel is the power control knob. This operates the variable condenser of the load-matching network. A mechanical problem was presented here that required solving. For reasons of panel symmetry it was desirable to have this knob located in the position shown. However, for electrical

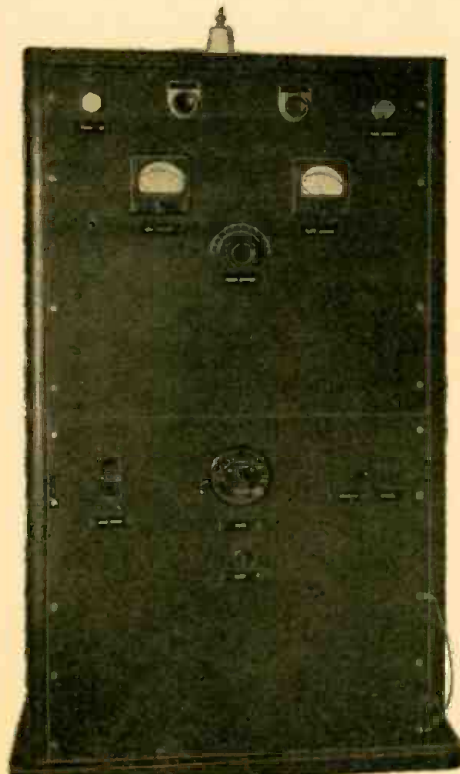

Fig. 6—Front view of the complete equipment.

reasons it was desirable to have the condenser located at the edge of the chassis, as can be seen from Figs. 2, 3, and 7. Therefore, it was necessary to resort to a bevel gear drive arrangement. Part of this can be seen in Fig. 2. Four small brass rods, some  $\frac{1}{2}$  x  $\frac{1}{8}$ -inch brass strip, a  $\frac{1}{4}$ -inch insulated shaft coupling, and some incidental hardware were obtained, and the drive was homemade. The strip was used to make supporting brackets. The insulated shaft coupling is necessary as the entire condenser is hot to ground.

On the lower panel, at the left, is the main switch and circuit-breaker, in the center is the work-cycle timer, directly under it is the reset button for the plate overload relay, and to the right is the AUTOMATIC-MANUAL switch.

Fig. 7 shows clearly how the two chassis look when mounted in place in the cabinet. The r.f. choke is shown at the upper left in the photograph. It is a homemade affair, mounted on standoffs on the inside of the cabinet. A 1-inch (outside diameter) pyrex glass tube, 9 inches long, was fitted with straps to mount on the standoffs, and 120 turns of No. 28 enamel wire, space-wound the diameter of the wire, were wound on the tube. The winding length was about 6 inches. Also shown in this photograph is the inductor of the load-matching network, mounted directly in the cabinet, under the top. The cabling arrangement for connecting the terminal boards of the two chassis is also shown. At the extreme right of the lower chassis is shown the Hubbell twist-lock male receptacle, with which the power cord engages. Mounted on the lower door-jamb is seen the door safety interlock. With the rear door of the cabinet open, it is impossible to apply the high voltage.

#### Load-matching network

To those who have had experience only with communication apparatus the load-matching network previously referred to may seem somewhat strange. However, the impedance of a dielectric-heating load differs considerably from that of an antenna. This impedance must be matched to the electronic generator to effect a satisfactory transfer of energy to the work. Then again, with an experimental unit, a wide variety of loads will be encountered. The network described is sufficiently flexible to accommodate the range of load im-

pedances likely to be encountered.

When everything has been assembled and connected the first step is to condition the rectifier tubes. Close the main circuit breaker and allow the filaments to burn for about 15 minutes. This will evaporate any mercury that may have been deposited on the tube filaments. Next the grid adjustment should be made. Set the cathode tap on the tank coil one-third of the way from the grid end of the coil. Close the rear door and push the START button. This applies the high voltage to the oscillator tube; and, if everything is in order, the unit will oscillate. This can be determined by noting if a reading appears on the grid-current meter. If no reading appears, something is wrong, and all connections should be checked. When everything is in order, the grid current should be 100 milliamperes at no load. If the reading differs from this, the position of the tank coil tap should be changed until it is correct. When this has been accomplished, the unit is ready.

Fig. 8 shows a typical arrangement for heating an experimental load. An electrode is fashioned from copper or brass to overhang the charge a small amount, such as  $\frac{1}{4}$  or  $\frac{3}{8}$  inch, as shown. This is the high-potential electrode. The grounded electrode may be a brass or copper plate, bolted or otherwise connected to the cabinet. It is usually desirable to insert a thermometer in the charge so that the change in temperature may be observed during the heating cycle.

The only remaining step is to tune the generator to match the load impedance. With no load on the unit, the plate current will be about 0.13 amp. Set the tap on the network inductance at about the mid-point of the coil. Apply the power and vary the tuning condenser until the plate ammeter reads 0.6 amp.

(Continued on page 85)

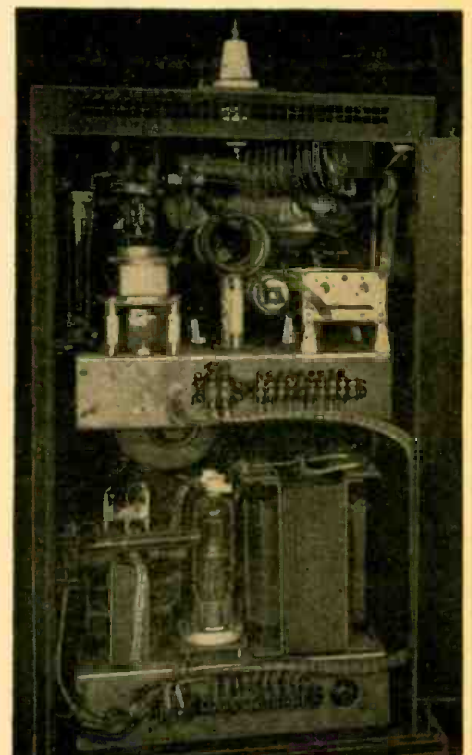

Fig. 7—The complete job viewed from the rear.





# Sunspots and Radio



Dr. Harlan True Stetson is a Research Associate of the Massachusetts Institute of Technology and Director of its Cosmic Terrestrial Research Laboratory at Needham, Mass.

## The Sun's magnetic storms are important to listeners on earth

By HARLAN TRUE STETSON

made at more than 50 ionospheric stations in various parts of the world. A variable-frequency pulse surges to the ionosphere and back until the critical frequency is reached, when the wave breaks through to outer space. How the average critical frequencies between 9.00 am and 3.00 pm respond to sunspots, both at the E- and F-layers of the ionosphere, is depicted in Fig. 1. From these critical frequencies it is simple arithmetic to calculate the electrons per cubic centimeter at these levels.

How well a radio wave is received over a long-distance path depends upon: (1) how well it is reflected by the ionized layer concerned; and (2) how much of the wave is attenuated through absorption in the lower ionized layers through which the wave passes twice in its flight upward and return from the reflecting layer. Waves of broadcast frequencies are turned back from the E-layer at a fairly constant height of about 110 kilometers. The shorter waves from 1,500 to 30,000 kilocycles depend more upon the F-layer, 200 kilometers high, for their reflection. Waves reflected from the F-layer must pass twice through the E-layer and suffer absorption, depending upon the number of ions or the electron density in this lower layer.

To trace the many vagaries that influence radio reception was the primary reason for the establishment of a Laboratory for Cosmic Terrestrial Research at Needham, Massachusetts, associated with the Massachusetts Institute of Technology. Here 7 recorders are constantly at work with automatic pens of potentiometer recorders geared to special receiving sets, crystal-controlled, that receive waves at different frequencies over different paths from distant

stations. More than 20 years' records, covering 2 sunspot cycles, have accumulated on the reception of WBBM, Chicago, in the broadcast band; and the years are accumulating for which records have been received from WWV, the National Bureau of Standards standard-frequency transmitter, sending out waves on 5, 10, and 15 megacycles continuously 24 hours in the day.

With the growing interest in the higher-frequency FM and television, waves too short to be reflected from the usual ionospheric ceilings are recorded by way of tropospheric reception, the

**W**ITH sunspots staging what is probably their greatest activity for three centuries, radio communications are experiencing abnormal transmission conditions. Frequencies in the 50-megacycle band have been crossing continents and oceans with unheard-of clarity. All this comes about with the increase in ionizing radiation from the sun concomitant with a peak of solar activity which certainly has not been rivaled since 1778.

It is common knowledge that the ultraviolet radiation from the sun augments the electron densities in the upper layers of the ionosphere from which dx transmission is reflected. The prediction of communication frequencies depends upon the time of the day, the season of the year, and—equally important—the sunspot cycle of 10 to 11 years' duration.

Every hour on the hour records are

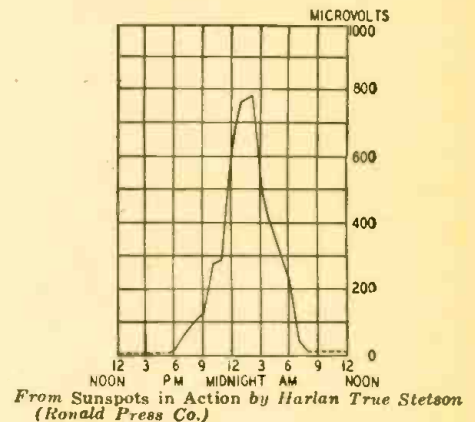

Fig. 2—Changes in signal strength of WBBM, Chicago, at Needham, Mass., December, 1941.

troposphere being that lower layer in the ionosphere, underlying the stratosphere, in which all our weather is made. In these records close correspondence between meteorological changes and radio reception has been found.

After Pearl Harbor in December, 1941, WBBM broadcast on 780 kc 24 hours in the day to inform the world of the latest developments in war news. This gave us the opportunity to record WBBM's variation in field strength 24 hours continuously. The results of this reception are shown in Fig. 2. It will be observed that during the daylight hours waves at this frequency were so heavily absorbed as to be scarcely perceptible at Needham over the 851-mile path. After sundown, near 6 pm, with the recombination of ions in the lower layers, reception begins to increase rapidly, rising from near zero to nearly 800 microvolts at the receiver by 2 am, and thereafter diminishing and fading out after sunrise about 8 am. This is a clear demonstration of the diurnal variation due to changes in the ionization of the upper

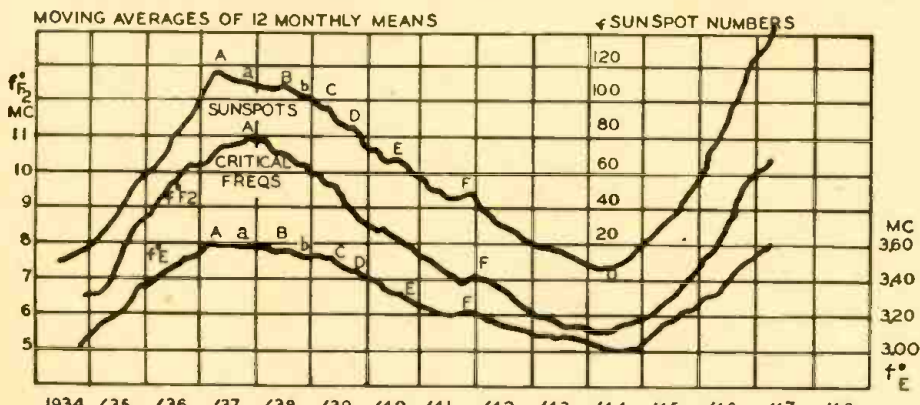

Fig. 1—Sunspot periods vs. critical radio frequencies (values averaged 9-15 hours EST).

atmosphere, chiefly in the E-layer which is responsible for this long-distance reception at broadcast frequencies.

If we confine our attention to broadcast reception from WBBM until 9 pm, we shall discover a marked seasonal variation. In Fig. 3 a field of 500 micro-

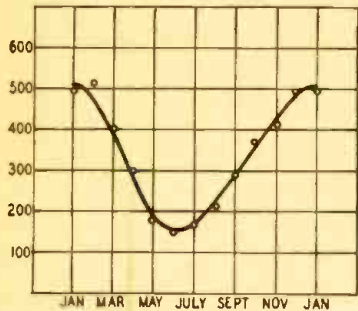
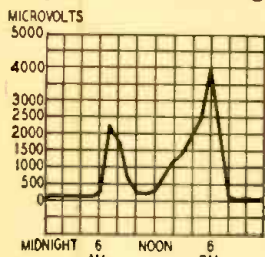

Fig. 3—Field variations, reception at 9 pm.

volts at the receiver in January falls to nearly 150 microvolts in June, rising again with the advent of winter. This is easily explained by the increased absorption caused by heavy ionization of the lower layers due to the long summer



From Sunspots in Action, Ronald Press Co.

Fig. 4—Daily variation, WWV's 5-mc signal.

days and high altitudes of the sun. Here we deal with night E ionization.

In Fig. 4 we have a record of a single day's reception on December 10, 1945, from the 24-hour recorder of WWV, the National Bureau of Standards standard-frequency signal on the 5-mc frequency. Low reception during the night hours is followed by an abrupt increase following sunrise with a field of about 2,300 microvolts, as the increasing number of ions in the F2-layer produces better reflection of the waves in the 60-meter band. Thereafter, as the sun attains higher altitudes with more penetrating radiations, ionization builds up in the lower E-layer, increasing the absorption and therefore the attenuation of these waves, causing a drop in field intensities until the noon hour. With the declining sun in the afternoon recombination of the ions in the E-layer diminishes the absorption, and field intensities again rise until about 6 pm. Thereafter, following sunset, recombination sets in again in the ionized F-layer. Poorer reflection results, and field intensities drop rapidly toward the low night values. This curve, typical of the winter months of 1945, can change materially with the sunspot cycle.

With the increase in sunspots in 1946 the ionizing power of the ultraviolet light of the sun increases enormously. During the daylight hours more and more ions are created in both the F2- and the E-layers and slower recombination of the E-layer during the night hours makes for higher values of field

reception. The characteristic change from summer to winter is clearly shown in Fig. 5 where from January, 1945, to June, 1945, we have the expected metamorphosis of the wintertime pattern to the summertime pattern; with the subsequent return to the wintertime pattern in December, 1945, and January, 1946. If one traces the pattern from January, 1946, onward, it can be seen that by early March in 1946 the diurnal reception curve has already gone over into the summer pattern with high night values from WWV and low daytime values due to heavy E-layer absorption.

Now comes the surprise! The summertime pattern of 1946 did not return to the wintertime pattern even though shorter days and longer nights brought decreasing solar altitudes with the progress of the season. The reason for this nonreturn to the winter pattern at the end of 1946, which, as shown in Fig. 6, persists throughout the spring and summer of 1947, is to be explained on the basis of the sudden rise in sunspots which took place during the year 1946 and carried over until 1947. The marked rise in the sunspot curve is shown in Fig. 7. Experience with previous sunspot cycles tells us that the ultraviolet radiation from the sun is about twice as great at sunspot maximum as at sunspot minimum. It is believed, therefore, that the increasing ionization of the sun accompanying the rapid rise in sunspots more than offset the shortening days of winter and the lower solar altitudes which normally bring about the winter pattern.

We are now nearly at the peak of the present sunspot cycle and we may anticipate that before 1948 is over the

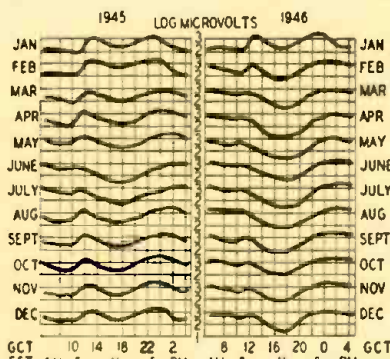

Fig. 5—Monthly diurnal variation, WWV, 5 mc.

intensity of the ultraviolet ionizing radiation from the sun will start again to diminish, with a return of this ionizing radiation of sunlight to more nearly normal values. As the sunspot cycle fades, we shall anticipate a return of WWV's 5-mc field-intensity pattern to the winter type. Should this happen in the winter of 1948 we may surmise that we are definitely past the current maximum.

All this goes to show how important sunspots are to the radio listener and to communication engineers. Critical frequencies alone may tell us what are the maximum usable frequencies; unfortunately, critical frequency data alone do not make allowance for the attenuation of the waves which may be introduced by the ionization of the at-

mosphere at lower levels. For this reason radio engineers are becoming more and more interested in recorded field intensities at different frequencies over different paths as a means of improving predictions.

It must be understood that at least 2 different types of interruptions to radio may come about through solar disturbances. One of these is attributable to the radiation of the sun in the extreme ultraviolet end of the spectrum. Such an effect is observed almost immediately, since it takes only 8 minutes for light to travel from the sun to the earth. Occasionally solar explosions accompanying sunspots take place, causing ultraviolet flares on the solar surface akin to an atomic bomb explosion. These flares may result in a momentary blackout of radio communications on all frequencies. Such interruptions, from the records obtained at the Cosmic Terrestrial Research Laboratory, may last from 15 minutes to an hour or more. These fadeouts, to which attention was originally called by Dr. J. H. Dellinger of the National Bureau of Standards, have sometimes been called Dellinger effects. They occur only on the side of the earth exposed to the sun's rays.

Another effect, more far-reaching and of longer duration, is attributed to electrified particles emitted from the sun in the region of sunspots. It is believed that from these gigantic solar whirlwinds particles are shot earthward which, when reaching the earth's atmosphere, so heavily ionize it as to disrupt the radio ceilings over the entire earth. They are of sufficient intensity to cause gorgeous displays of the aurora, or northern lights, which then blaze with great brilliancy, like neon lights advertising an electric show, from 200 to 400 miles aloft. It is then that rivers of electrons start flowing in invisible space, inducing even in the earth itself electric currents that interfere with telegraph lines and teletypes, garbling messages as though a thousand gremlins were let loose on the teletype keys.

One effect of these electrified particles is to create such heavy ionization in the lower atmosphere of the earth as to absorb radio waves and kill communications. These disturbances may last not only for hours but sometimes for days. Long-continued observations at the Cos-

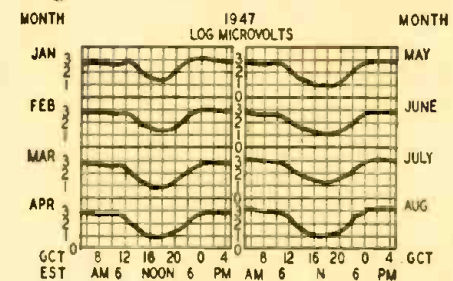
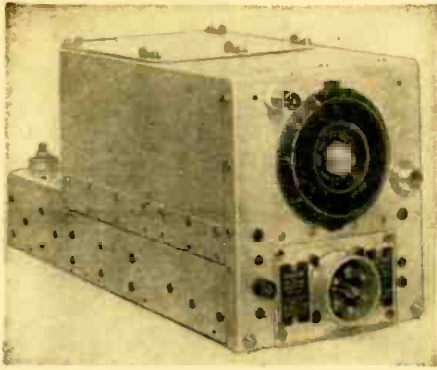

Fig. 6—Mean diurnal variation, Jan.-Aug. 1947.

mic Terrestrial Research Laboratory have shown that in general the appearance of sunspots affects first the highest of the radio ceilings, the F-layer. Short-wave communication by way of this F-layer is therefore the first to be seri-

(Continued on page 72)

# BC-946 AS B. C. RECEIVER



The BC-946 is usually obtained in this form.

This little aircraft unit can be converted into a home radio of unusual selectivity and sensitivity

By LYNN G. HERBERT

**D**OES your family feel like the shoemaker's children who had no shoes when they start listening to that 4-tube table model bloop-er? Then here is your chance at the expense of a few bucks and a dozen soldering-iron burns to have them bragging to all the neighbors about the fine radio you "made" for them.

It all comes from Uncle Sam's release of the SCR-274-N, out of which you will need the broadcast range receiver, BC-946. For a very modest hunk of capital you get 1 r.f., 2 iron-core i.f.'s, and beam power output similar to the 6V6.

Since you will want to keep the cost down, you will probably put in a 50Y6 as a rectifier in series with the six 12.6-volt, 0.15-amp tubes. The 50Y6 is used as a voltage doubler. The young'un can get between the chassis and a radiator safely without being electrified, for the chassis is connected to the radiator through a 100-watt projection lamp to trade a few electrons for the plate supply. If you don't like that idea, stick to the conventional a.c.-d.c. hookup. The average family will need about an hour's

training on the subject. All this assumes that you live in an average house with 3-wire distribution system of 220-110 volts a. c. with grounded neutral. If it is some odd arrangement, better put a condenser to ground.

The first thing you will want to do after your purchase is to rip the bottom cover off and poke around inside to see what parts you can take out to put in something else. The way the wiring is laid out will frighten you—strictly G.I. Now that you have had a look, pull out the tubes and remove the 2 upper shield covers. To get the inner one off, loosen the screws holding the first two i.f. transformers, and pull them off their plugs. If you own a double-jointed screw driver, you can spend twice the time getting those 2 screws out and not remove the i.f.'s.

Drill into the end of the tuning control gear about 1/2 inch with a 3/16-inch drill. Due to the movement of the assembly during drilling, you get a nice tapered hole and can file a brass rod or the end of a volume control shaft down to fit. The other end will fit any old knob from the junk-box.

Unplug the tuning coil assembly for elbow room, and take off the front plug

and its various cans. Pry the inner connector out carefully, for it is used with the rear one as a speaker plug. Block up this hole with a piece of sheet aluminum and drill the 3/8-inch volume control hole in it. Now you can pull off the 3- $\mu$ f can on the front. Remove the 239-kc b.f.o. can and the adjacent output transformer (ES-691027) behind it in the back corner of the under-chassis space. Now remove the r.f. hash choke L14 and the dynamotor socket beneath it. Unscrew the dynamotor shock mounts. The 50Y6 replaces the socket. Remove the components of the b.f.o.—R14, 15, 16, 17, and C26. To remove C29 and C31, remove the screws attaching choke L15. Throw R10 in the junk-box. During the conversion you will most likely have to remove the screws of cans of condensers to get at various components. A socket on the power supply plugs into the jack (J2) on the back of the receiver chassis.

The large capacitances of the rectifier filter condensers may alarm you, but all the peak currents used by the 12A6 during loud passages or bass notes must come from them. A heat shield might be placed between the filter condensers and the rectifier tube to lower the operating temperature of the condensers. If so, it should have a large area so as to dissipate the heat well. The resulting ripple level was very low in my set.

The audio could possibly use more gain to drive the 12A6 to full output, but it was more than ample with the 8-inch speaker in the exponential horn used here. The inverse feedback network with a 150,000-ohm resistor and .001 condenser adds a little wool to the response and trims down the harmonic distortion. The cathode bypass of the 12A6 is intentionally small to boost the high frequencies from about 4,000 cycles up. You might want this boost to start in at a lower frequency, so try values of about 0.5  $\mu$ f. The 30- $\mu$ f condenser from the 12A6 cathode is moved over to the cathode of the 12R7.

Automatic volume control is applied to the r.f., i.f., and mixer stages. The

(Continued on page 65)

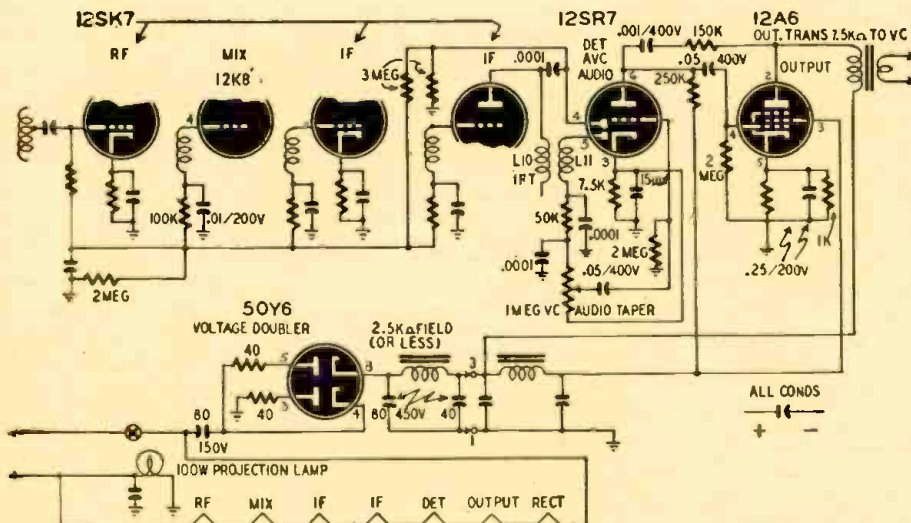

Schematic showing all changed circuits. A complete diagram is usually sold with the set.

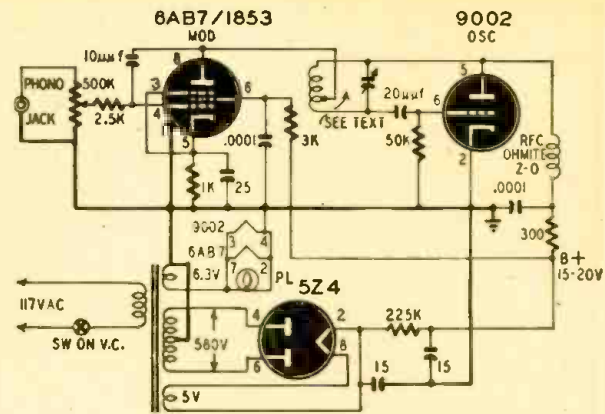
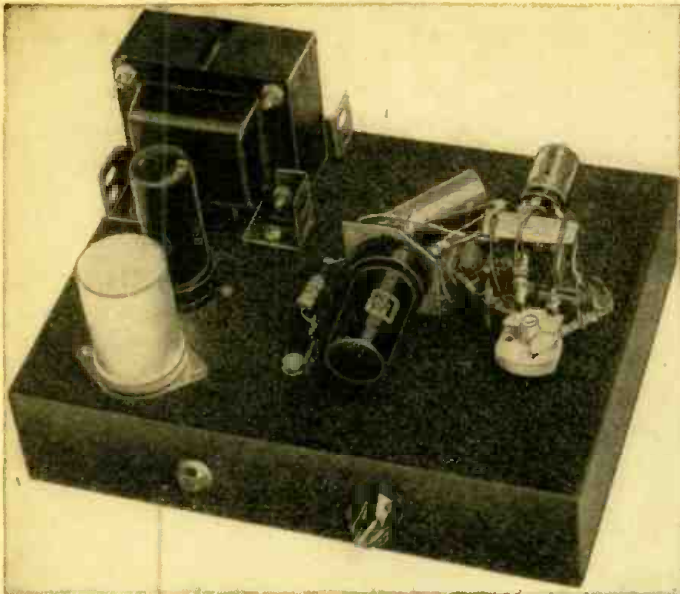

Schematic and photograph of the FM wireless record player. Note that all grounds are led to one point (behind small variable condenser). These points are important in high-frequency work, and successful operation may depend on them.

# RADIO RECORD PLAYER FOR YOUR FM RECEIVER

By RICHARD H. DORF

FOR many years phonograph oscillators have been very useful and popular. They are, in effect, miniature broadcast stations, and make it possible to locate the pickup-turntable unit anywhere in the room. Unlike ordinary portable phonographs, the reproduced frequency range need not be restricted by the small speaker which fits into the phonograph case. Played through the family radio receiver, records are usually enhanced in quality.

Not the least of the wireless record player's advantages is comfort and convenience. The small player can easily be put on a coffee table or an end table, so that the operator need not get up from his seat to change records. If space is scarce, the phonograph can be stored in a closet when not in use.

The common phonograph oscillator which works in the standard broadcast band is subject to most of the usual disadvantages of AM transmission and reception. It is often difficult, especially in large cities, to find a place on the dial where there are no whistles or "monkey chatter." This is particularly true at night. Unless the oscillator puts out a substantial signal, interference may be heard; and if it *does* put out a substantial signal, the neighbors and the FCC may be heard! In addition, most AM receivers do not have particularly good audio-frequency response or distortion ratings. Further, an amplitude-modulated oscillator can never be modulated 100%, so receiver volume must be turned up more than usual, admitting

any hum and extraneous noise that may be lurking in the vicinity—including carrier hum.

There is a cure for these problems. Any critic who has ever listened to a good FM broadcast knows that there is little or no interference, that most FM receivers have good a.f. characteristics, and that FM tone has that something which, for lack of a better term, we call "presence." It is a quality no AM broadcast can produce—a feeling that the speaker or musician is right in the room with you.

So—why not a frequency-modulated phono oscillator? The FM oscillator described here has practically no frequency discrimination or distortion in itself and, received on a good FM receiver, its sound quality is limited only by the a.f. system of the receiver. It produces satisfactory results with a signal just about strong enough to operate the receiver's limiter.

Bottom view of the oscillator. Most of the wiring is on top.

There is no cross talk with broadcast stations, no monkey chatter. It is not necessary to find a quiet spot on the dial, since, as long as the oscillator signal is at least twice as strong as that of a station on or near its frequency, that station will be completely blanked out. The signal strength is great enough to produce this effect at distances up to at least 30 feet. At substantially greater distances, the oscillator cannot be heard; you are safe from the neighbors and the FCC.

FM receiver production is in its stride now; more and more homes are FM-equipped. With this phono oscillator you will have a miniature FM station, capable of high-quality reproduction.

The FM oscillator is shown in the photograph. As the schematic diagram reveals, its construction is simple. It is built on a standard 7 x 9 x 2-inch metal chassis and has its own a.c. power supply.

The oscillator is an ultraodion. This is probably the simplest type of v.h.f. oscillator, and its stability is entirely adequate. The 9002 tube is suitable because

(Continued on page 71)

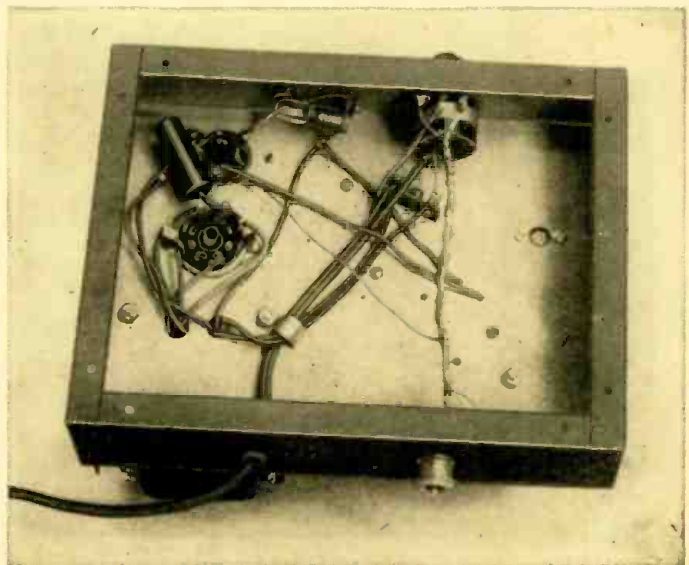

# Pulse Code Modulation

Radiophone signals can be relayed a large number of times without deterioration by this new system

By FRED SHUNAMAN

**R**ADIOTELEPHONY got its start on the sea and in the air, where the connecting lines of the older line telephony could not be strung. Recent events like the opening of the New York-Boston microwave circuit indicate that it is preparing to take over on land as well. The future will see towers on hilltops beaming or funnelling signals to other towers on the far horizon as well as the familiar complex webs of wires stretching endlessly on multi-

crossbarred poles or buried co-axial cable lines.

Two stumbling-blocks have hampered the advance of radio in commercial telephony. One is the difficulty of transmitting a large number of messages at the same time on one channel, as can be done easily over *multiplex* wire circuits and coaxial cable. The other is destruction of the signal by atmospherics, electrical interference or distortion introduced by transmitting, relaying and receiving apparatus. To reach great distance on the ultra-high frequencies available for commercial telephone use, many relays are necessary. The number of times a signal can be relayed depends on the amount of extraneous material it picks up on the way. After a large number of relay steps, the voice content of the message may be lost—buried under a mass of atmospherics and electrical noise.

Pulse Code Modulation, a development of Bell Telephone Laboratories, undertakes to solve these two problems simultaneously. Like earlier forms of *pulse modulation*, it makes no attempt to put the whole signal wave on the air. Instead, small *samples* of the signal wave are taken at evenly-spaced intervals. These samples, which register the signal voltage, are transmitted as pulses. They build up at the receiving end substantially the same signal wave as the one at the transmitter.

To follow exactly the frequency of the sampled transmission, the sampling rate must be at least twice as great as the highest frequency transmitted. Samples are taken 8,000 times per second to transmit telephone conversations which are filtered to remove all frequencies above 3,400 cycles. If the sampling drops be-

low this 2-1 ratio confusion between a sampled frequency and the difference between it and the sampling frequency arises; a sampling frequency of 8,000 would be unable to distinguish between 6,000 and 2,000 cycles (RADIO-CRAFT, March, 1946).

Sampling solves the problem of multiplexing, for the samples can be taken in a much shorter time than the 1/8,000 second allotted. In the present Bell Laboratories experimental set-up, 12 conversations can be sampled in that time. Thus 12 transmissions can be sampled in turn and carried on the same frequency, each one "sharing time" in the 1/8,000 second interval. Circuits at the receiving end unscramble the multiplexed signals and distribute them to their proper channels.

Older forms of pulse modulation attempted to solve the twin problems of multiplexing and multiple relaying. Successful in the former, they did not succeed in getting rid of the cumulative effects outside of interference and noise generated in the radio equipment itself. *Pulse Amplitude Modulation* (Fig. 1-a) was least successful. Static or interference can falsify the message carried by any one pulse, distorting the received signal as in any other form of AM. *Pulse Position Modulation* (Fig. 1-b)—more like FM than AM—was more successful. Instead of varying in amplitude with the signal, modulation caused the pulses to be made earlier or later than their unmodulated position in the center of the time channel. Since all pulses are clipped to uniform amplitude in the receiver, amplitude modulation introduced by noise voltages has no effect. Unfortunately interference or fading may destroy all but the leading edge of one pulse and all but the trailing edge of another, thus varying their relative position, and so distortion does creep in.

*Pulse Code Modulation* (PCM) (Fig. 1-c) also uses samples to tell its story at the receiving end, but instead of carrying its information by changing the position of pulses, each sampled voltage sends its own *code character* to the receiver or relay station, where it is either *decoded* to produce an exact replica of the sample, or *regenerated* to repair damage caused in transmission, and sent out again as a perfect code group, which can be regenerated and relayed an indefinite number of times.

This advantage is gained at the cost of complication in the transmitting and receiving circuits. Fig. 2 is the rear view of a panel which houses the equipment

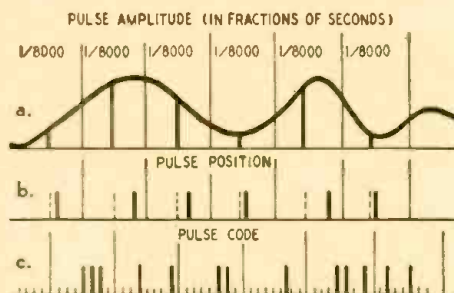

Fig. 1—Pulse modulation, 3 typical systems.

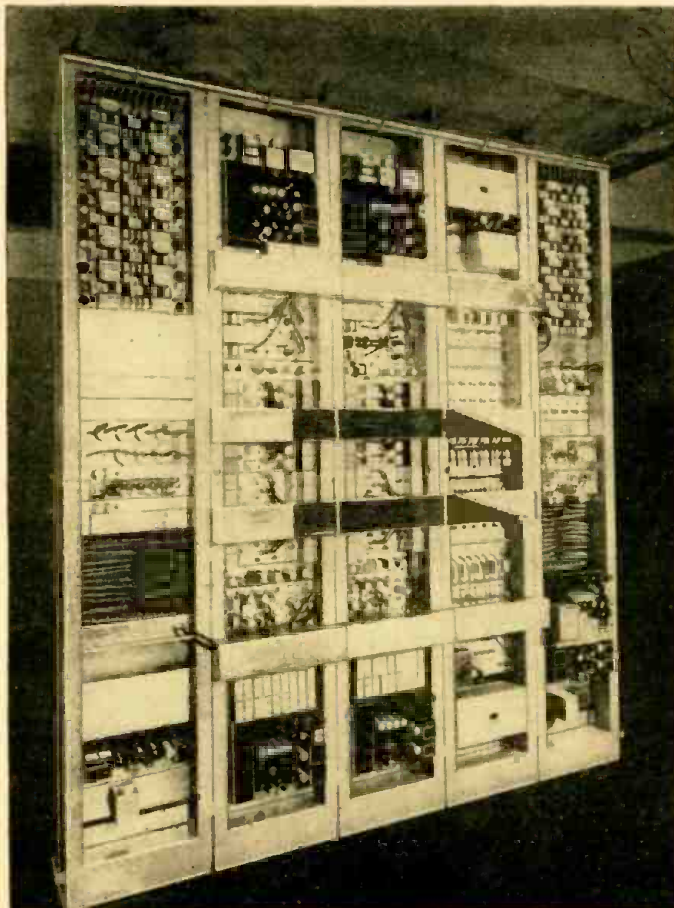

Fig. 2—Rear view of the Bell Laboratories experimental equipment.

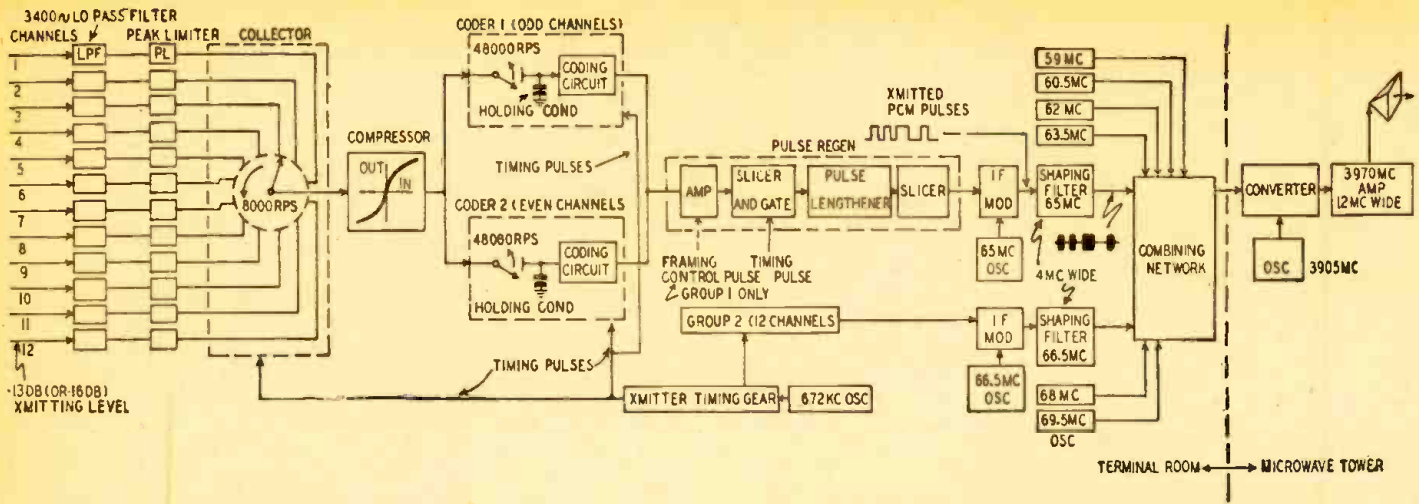

Fig. 3—The complete transmitting apparatus for one experimental circuit, indicating also how additional circuits may be accommodated.

for 2 12-channel circuits, with some auxiliary equipment which might be used for 8 more. Together with old circuit features, such as electronic switches, expanders, clippers (or slicers) we find some new components and ideas. Among these are the *coder* (shown on the cover) *quantizing circuits* and *decoders*. Parts of the circuit resemble older pulse modulation equipment (see *PPM—New Technique*, RADIO-CRAFT, February, 1946). Voice signals from each of the 12 channels of a circuit are passed through filters and limiters (Fig. 3) then are sampled by an electronic switch which contacts each channel 8,000 times per second. Each sample is then put through the compressor, from which it goes to another pair of switching circuits which route the samples from even-numbered circuits through one coder and those from the odd-numbered channels through the other. This is done so the holding capacitors have time to discharge completely between signals, and thus prevents interference (crosstalk) between channels. After coding the signals are amplified, then go through a *slicer* and *gate*, which clip them off to an even amplitude and permit only very narrow pulses to pass in the exact positions required by the pulse code. These exactly positioned pulses are then lengthened by a following circuit to make them easier to transmit than the former very narrow (0.4-micro-second) pulses.

A second slicer again evens the pulses

and they pass to an i.f. modulator working on a frequency in the neighborhood of 65 mc. The square pulses go through a *shaping filter* to produce rounded pulses more suitable for radio transmission. A converter at 3905 mc beats with the i.f. and the sum frequency of 3970 mc is further amplified and fed to the horn or parabolic radiators of the antenna system.

Besides multiplexing in time, a number of channels divided in frequency may be transmitted by the same broadband transmitter, as shown in Fig. 3. It is expected that a complete system will be able to carry 8 such channels, or 96 telephone conversations, simultaneously.

Signals follow an equally complex course at the receiving end (Fig. 4). The multiplex signals are first converted back to the 65-kc intermediate frequency, detected and fed to the input slicer, which cuts them down to even amplitude. A switching circuit then divides the odd and even channels and sends them to the two decoders, after another gating and slicing. After decoding, odd and even channels are again combined and amplified, expanded to restore the original form before compressing, and distributed back on their 12 lines in the inverse process of sampling. The holding condensers reduce the amplification needed in the subsequent audio amplification of voice signals which reproduce those supplied to the transmitter, and a 3,400-cycle filter cuts off any high-note

noise or distortion products which may have been introduced into the signal in the various circuits.

### The pulse code

The code system is simple, and somewhat resembles a telegraph code in which only dashes appear. Each code

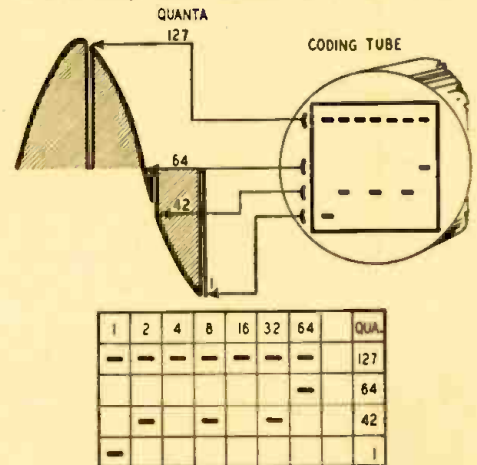

Fig. 5—How audio wave is sampled and coded. group is made up of seven spaces, and the code characters are made by filling some of these spaces with dashes and leaving others blank. By combining dashes and blanks as many ways as possible in the 7 allotted spaces, 128 different characters or code groups can be formed.

Samples taken at various points on  
(Continued on page 30)

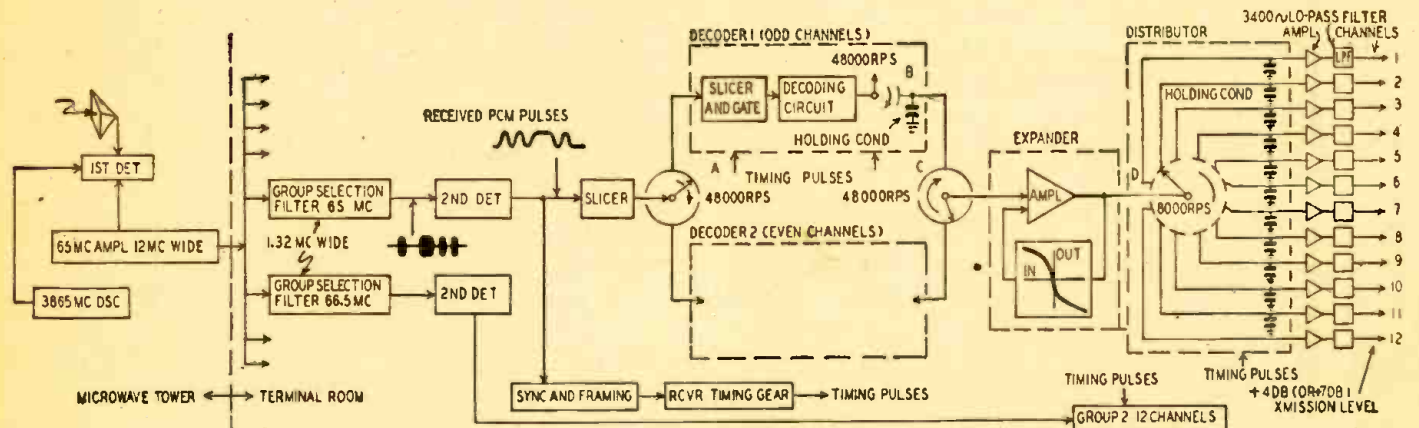

Fig. 4—The experimental receiver, with decoding equipment for one 12-channel group, and indicating parts common to several circuits.

the audio voltage wave produce their own code groups, as shown in Fig. 5. Each of the dashes is given a code value corresponding to its position in the frame. Thus a dash in the first position has a value of 1, in the last position of 64, and a code group composed of a dash in the first and last position, with nothing in the 5 spaces between, would have a value of 65.

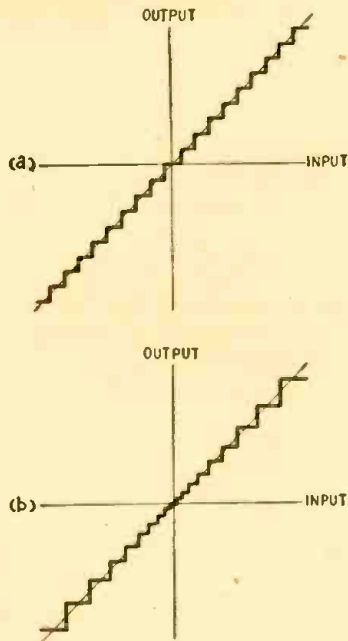

Fig. 6—Breakup of voltage into quanta steps.

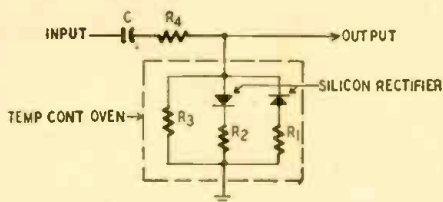

Fig. 7—Circuit of the compressor or expander.

Samples can then be taken only at 128 points or steps over the amplitude range. These steps (Fig. 6-a) are close enough together to reproduce voice excellently. A system with a larger number of steps has been used for music transmission. Each of these steps or quanta has its own code number, ranging from 1 to 127 in the system now used. The code number 64 represents zero signal, and low-level negative or positive swing is represented by numbers just below and above 64. High-level signal swings are represented by numbers near zero and 128.

### The signal compressor

In *quantizing*, or dividing the signal voltage into a series of steps, equal steps seemed to the ear to be too far apart for weak signals and appeared to be closer together as voltages increased. Instead of evenly-spaced steps like those of Fig. 6-a, what was needed was a series more like that of 6-b, in which more steps are available for low-level signals. Such a division is made by inserting a *compressor* in the circuit just before coding.

The compressor (Fig. 7) uses metal rectifiers, whose resistance is large to low currents but decreases as the current through them increases (RADIO-CRAFT, August, 1947, page 37). Two silicon rectifiers poled in opposite directions are shunted across the input to the coder. To make all compressors uniform, small padding resistors are connected in series with each rectifier and a large resistor is shunted across the unit. These resistors are adjusted till the compressor matches a standard unit. The compressor's d.c. resistance then ranges from about 6,000 ohms for very weak signals to only about 190 ohms at full-load peak.

The compressor is shunted across the coder input circuit, so that stronger signals are attenuated more than weak ones. The effect is as if the quantizing steps were farther apart for strong signals and closer together for weak ones (Fig. 6-b).

The *expander* in the receiver circuit (Fig. 7) is an identical unit. It is placed in the feedback path of an amplifier, so that its effect on the signal is exactly opposite to that of the pre-coding compressor. Since the two units are identical, the signal from the expander-amplifier has exactly the same form as it had before compressing.

### Coding tube and circuits

The actual coding is done by the special cathode-ray tube shown on our cover. It consists (Fig. 8) of an ordinary electron gun, horizontal and vertical deflecting plates and three elements which work together to code the signals. Each channel is sampled once in 1/8,000 second, and there are 6 chan-

nels for each coder, so the horizontal beam sweeps from left to right 48,000 times per second. It is blanked out on the return trace.

Voltage samples from the compressor are applied to the vertical deflecting plates. The electron beam may be swept across the tube at any point between the horizontal axis (no signal) and the top or bottom (maximum positive or negative signal).

The code is produced by the *aperture plate* and *quantizing grid*. The aperture plate, shown behind its quantizing grid in Fig. 9, has a number of vertical slots so placed that a narrow electron beam sweeping horizontally across it sends spurts of electrons through it to produce code characters like those of Fig. 5. A beam focused between the top pair quantizing grid wires (maximum positive signal) passes through 7 slots in the aperture plate, producing evenly-spaced pulses (code 1-1-1-1-1-1). One wire (step) below, the beam would pass through the aperture plate in all positions but the first, and the code would be 0-1-1-1-1-1. There are 128 steps separated by the wires of the quantizing grid, each with a different combination of marks and spaces. The lowest step (maximum negative signal), for example, produces the code 1-0-0-0-0-0-0.

The *quantizing grid* is very important. It holds the beam in a straight horizontal line and prevents it from straying up or down during a horizontal sweep. To so control the beam, a *quantizing bias* is picked up from the circuit which blanks out the electron beam on each return sweep. This bias pushes the beam up against the grid wire just above the sweep path selected for it by the signal. As electrons from the beam strike the grid, it emits secondary electrons. These are picked up by the *collector* and returned as a *quantizing feedback* to the vertical deflecting circuit.

(Continued on page 47)

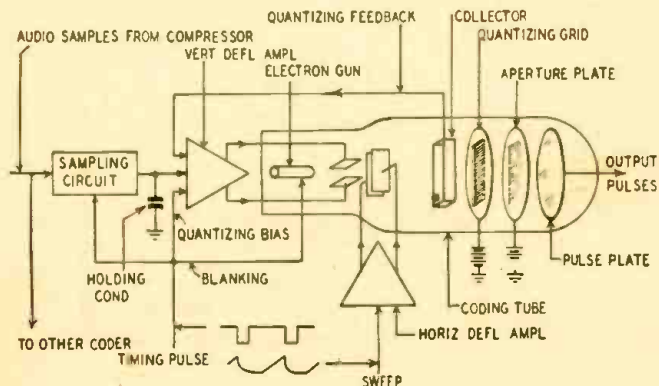

Fig. 8—The coding tube, most important feature of the system.

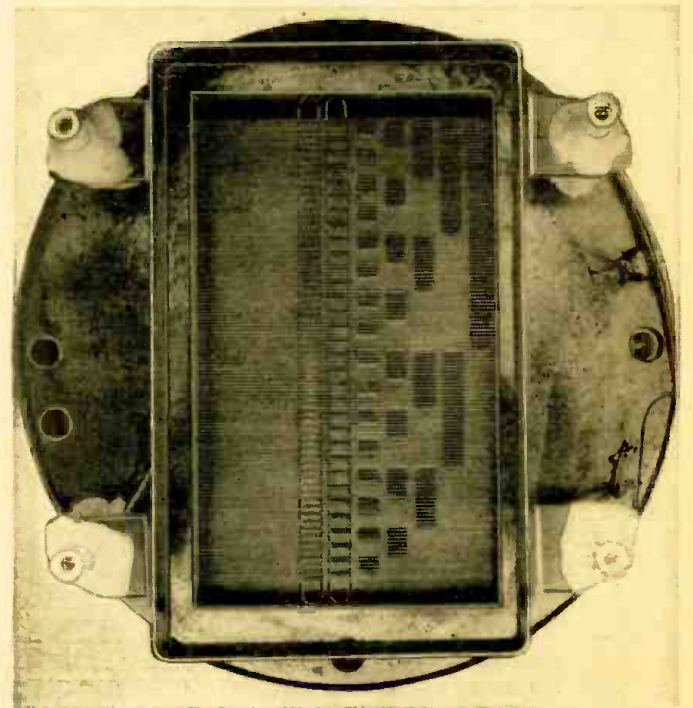

Fig. 9—End view of the aperture plate through the quantizing grid.



# MAGNETIC RECORDING

## Part IV—The electronic section of a modern magnetic recording and playback apparatus

By A. C. SHANEY\*

IT MAY be predicted safely that the major developments contributing most toward the improvement of magnetic tape recording will be in the discovery of new and improved magnetic tape manufacturing techniques.

It is equally safe to predict that tape recording will gain supremacy over magnetic wire recording. The major advantages offered by magnetic tape recording include:

1. It is virtually impossible to tangle tape.
2. Tape offers unlimited editing facilities. Sections may be spliced with ordinary Scotch tape.
3. Magnetic tape decreases the possibility of magnetic cross transference.
4. Magnetic tape may be operated at a considerably reduced speed.
5. Mechanical problems in handling magnetic tape are relatively simple

\*Chief Engineer, Amplifier Corp. of America

when compared to the mechanics of feeding a hair-thin wire at a constant speed.

6. There is every indication that magnetic tape will be reduced substantially in price as demand increases. The same cannot be said for the comparatively expensive process of drawing the equivalent of A.W.G. No. 28 stainless steel wire.
7. Speed for speed, magnetic tape is far superior to wire. At present, tape traveling at 4 inches per second can easily equal the response of wire traveling at 24 inches per second.
8. Magnetic wire produces an apprecia-



9-tube amplifier is housed in this long-playing recorder-reproducer.

ble variation in high-frequency amplitude level due to the twisting of the wire on its axis. This cannot happen with magnetic tape.

9. Most magnetic tape machines provide a high speed forward and reverse shuttling. Most wire recorders, on the contrary, do not offer this desirable feature, and the lack may make it necessary to play through a

(Continued on page 54)

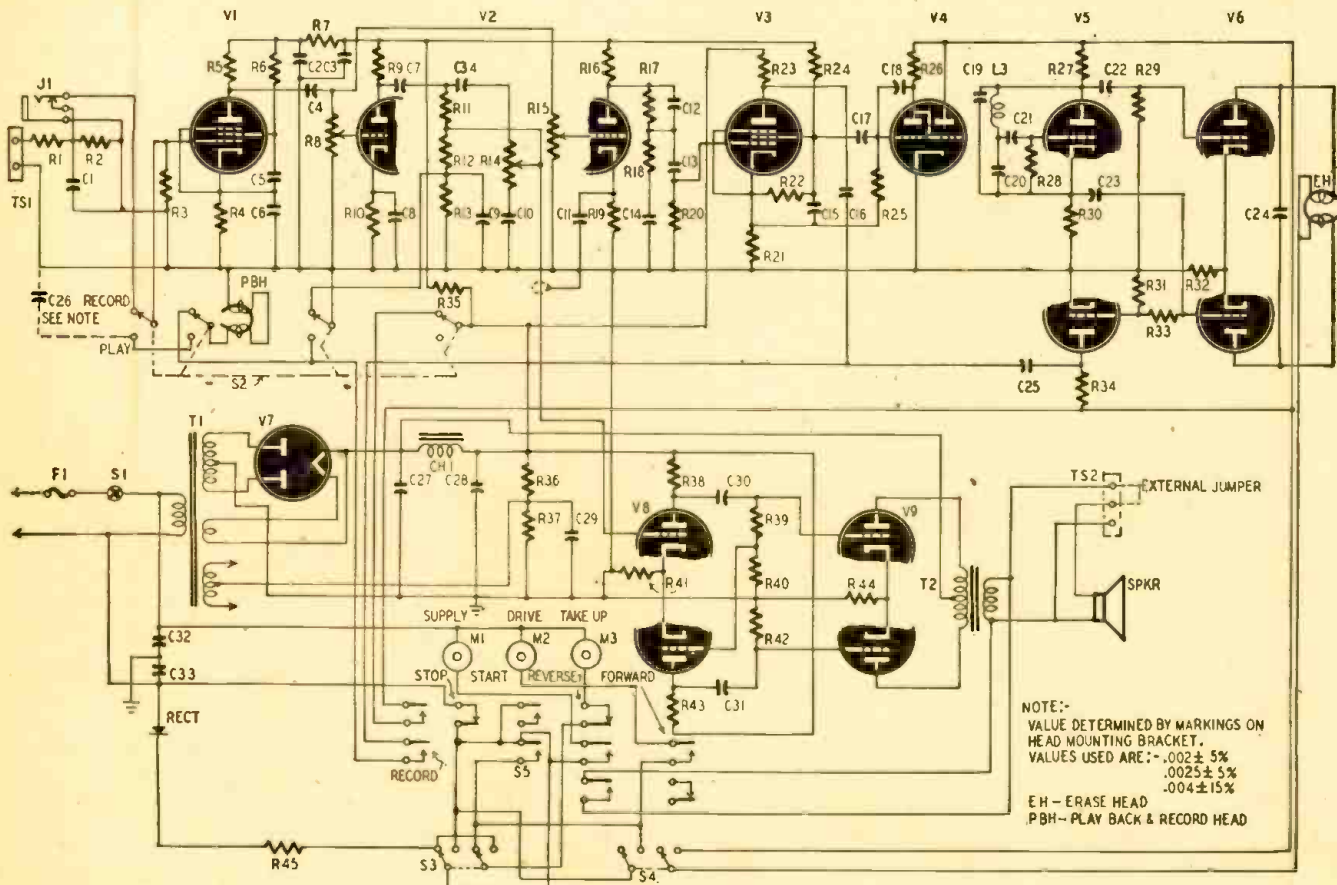

Fig. J—Schematic of the complete recording and playback amplifiers and erasing circuits. Circuit breakdowns appear in Figs. 2 and 3.

# Radio Set and Service Review



## The Collins Model 75A-1 Uses several new principles

By R. F. SCOTT, W2PW6

**T**HE Collins amateur-band receiver, Model 75A-1, embodies several features new to amateur receiver design. It is the first of its type to use *permeability tuning* and *double conversion*. These features do much to provide image-free reception and rock-like stability from a cold start—even on 10 meters.

It is a 14-tube receiver with six tuning ranges; one for each amateur band (80, 40, 20, 15, 11 and 10 meters). A well-calibrated mechanical bandspread system and highly stable oscillators provide reset ability to within a few cycles on any band. Tuning ranges of the bands are: 80 meters, 3.2 to 4.2 mc; 40 meters, 6.8 to 7.8 mc; 20 meters, 14 to 15 mc; 15 meters, 20.8 to 21.8 mc; 11 meters, 26.0 to 28.0 mc and 10 meters, 28 to 30 mc.

The main dial is of the slide-rule type, with a scale for each band. Each scale is divided into 100-kc points. The circular vernier dial has 2 scales. The lower scale is divided into 1-kc points for use on 80, 40, 20 and 15 meter bands.

The upper scale is used on the 11 and 10 meter bands and is marked in 2-kc divisions. The proper scales of both dials are lighted by operation of the band switch. Exact frequencies, in megacycles, are read by adding the settings of the two dials. If, for example, the band switch is set at 80 meters, the pointer on the main dial is between 3.3 and 3.4 mc and the vernier on 45, you find the frequency by adding the direct reading of the vernier dial to 3.3 mc. The frequency is 3.345 mc.

The hair-line of the vernier dial is adjustable 2 divisions each side of center position to compensate for variations in calibration that may arise with aging. WWV, on 15 mc, can be used for checking the calibration of the receiver and for setting the position of the vernier indicator.

### Double conversion

The block diagram and the chart at the bottom of the schematic diagram will make it easier to understand the tuning system. The block diagram shows 5 cir-

uits ganged to the tuning control. Six circuits are ganged to this control but one was omitted for simplicity. These circuits are permeability tuned with powdered iron cores connected to a movable platform linked to the tuning shaft.

When the set is tuned to a particular band, proper antenna and r.f. coils and crystal are selected. The incoming signal is amplified by the r.f. stage and mixed with the signal from the crystal oscillator at the plate of the first mixer. Tuned circuits in the output of the mixer resonate at a frequency equal to the difference between the signal and oscillator frequencies.

Oscillator crystals for the 4 lower frequency bands are chosen so the difference frequency is 2.5 mc at the low ends of the tuning range and 1.5 mc at the high ends. For example: A 5.7-mc crystal is used on the 80 meter band. It beats with 3.2-mc signal to produce a 2.5-mc difference frequency. A 4.2-mc signal beats with the crystal to produce a 1.5-mc difference frequency. The high-frequency i.f. transformers are variable between 1.5 and 2.5 mc and their tuning slugs are ganged with those of the r.f. and antenna coils. In this way, the i.f. transformers are always tuned to the difference frequency. The comparatively high i.f. places the image repeat point well away from the signal frequency thus increasing the image ratio.

The variable i.f. beats with a signal from the v.f.o. to produce a 500-kc output in the output of the second mixer. The v.f.o. is variable from 2 to 3 mc to provide a constant 500-kc difference between its frequency and that of the variable i.f. The second mixer is followed by two conventional i.f. amplifiers fixed-tuned resonating at 500 kc.

The same tuning principles are used on other bands. Note that crystal fundamentals are used on the 80 and 40-meter bands. On 20 and 15 meters, the *second harmonics* of the crystal oscillator produce heterodynes in the range of the variable i.f. amplifier. The *third harmonics* of crystal frequencies are used to produce beat frequencies between 5.5 and 3.5 mc for signals on 10 and 11 meters. Shifting to a higher variable i.f. eliminates image response on these bands. When the variable i.f. is in

(Continued on page 74)

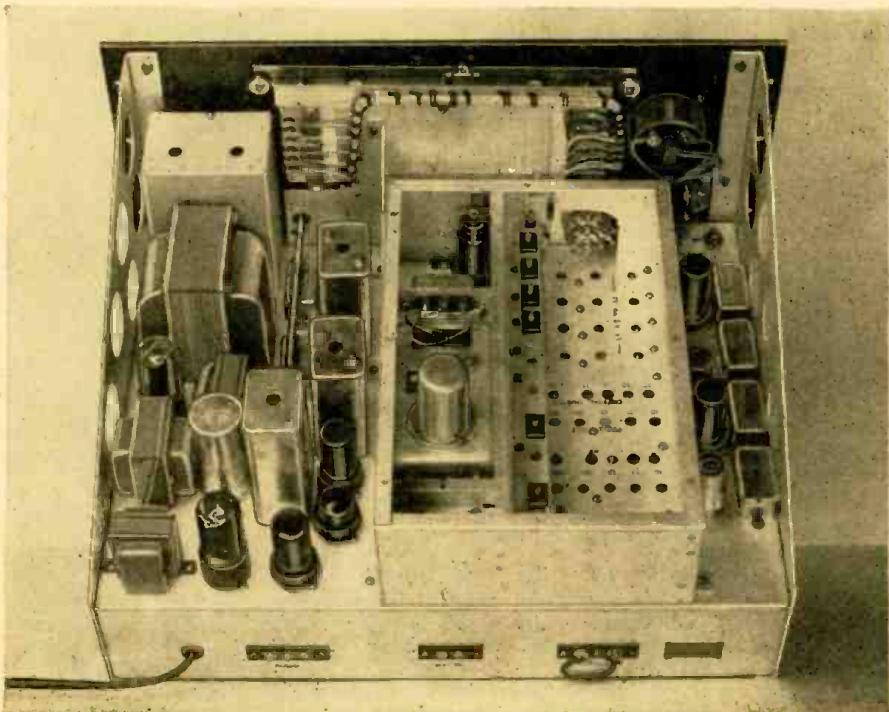

Rear view of the receiver. All tuning components are contained in the center compartment.

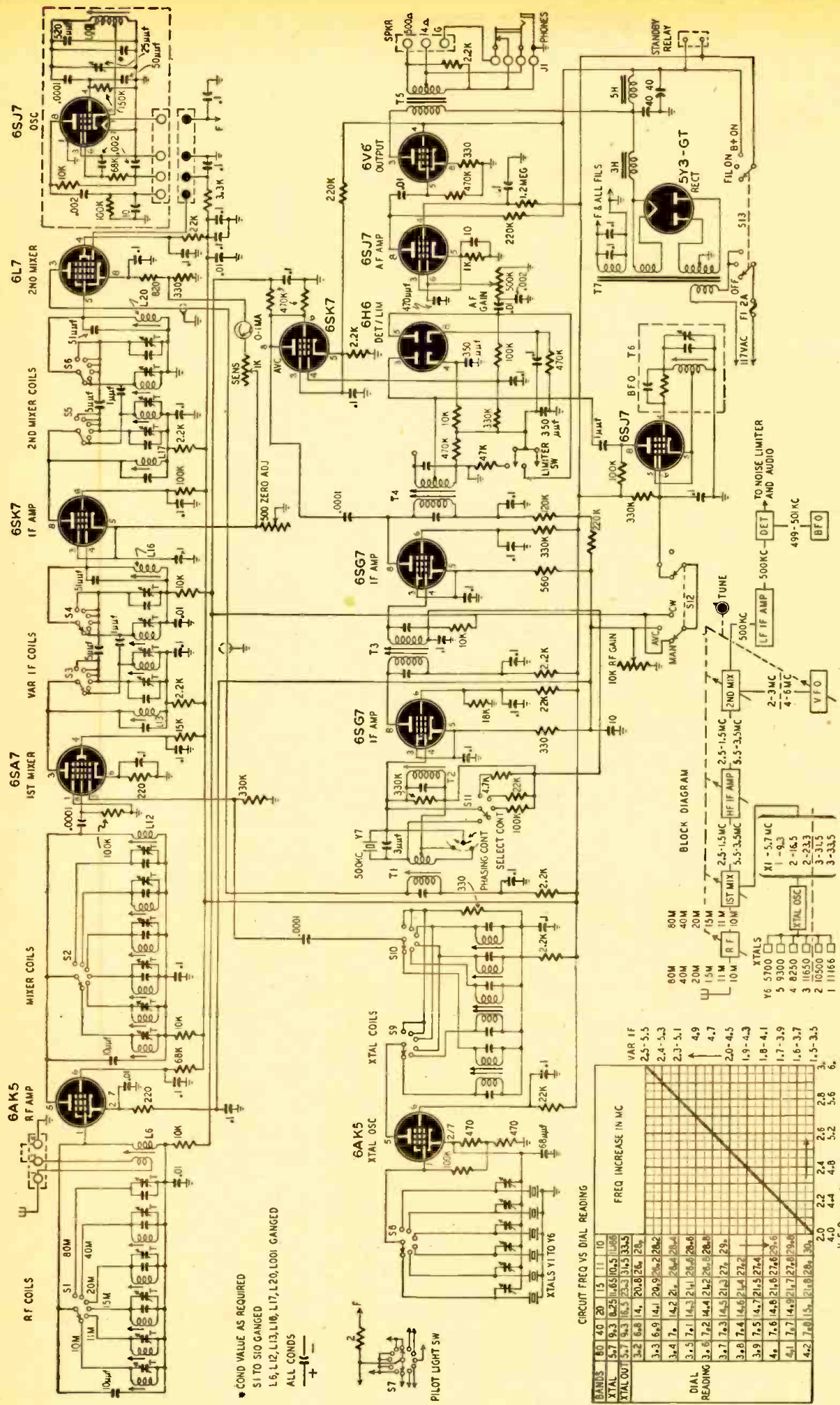

COND VALUE AS REQUIRED  
 S1 TO S10 GANGED  
 L6, L12, L13, L16, L17, L20, L001 GANGED  
 ALL CONDS  
 S7 PILOT LIGHT SW

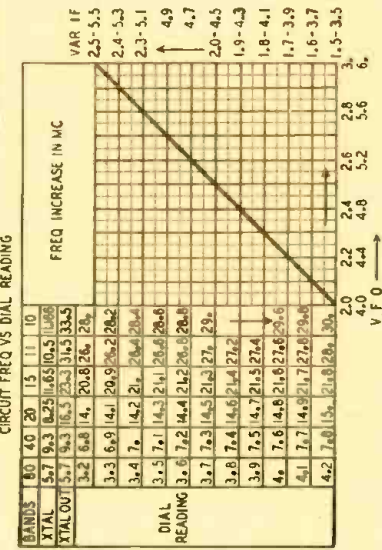

The Collins Model 75A-1, a 14-tube receiver, is designed solely for use on the amateur bands. Among a number of interesting features, it uses fixed crystal-controlled oscillators, and tunes by varying the intermediate frequencies.

# Signal Tracer Is Hand-Size

By CHARLES W. CARRUTHERS

**T**HIS practical signal tracer fits in the palm of your hand. It is not limited to the service bench, either! Batteries make it a very handy instrument for work in the field and reduce the problems of hum and the hot chassis of a.c.-d.c. instruments.

Making the unit so small that one can hold it in one's hand without tiring has a real advantage from the electrical standpoint. One can do away with special test leads and use very short unshielded probes mounted on the signal tracer itself. This makes it a simple matter to keep the r.f. input capacitance low and still have enough signal available at the grid of the first tube to keep the signal-to-noise ratio high.

It was designed to fulfill the following specifications:

1. Sufficient r.f. sensitivity to be able to pick up the signal at the antenna coil before any amplification has taken place.
2. Small enough coupling capacitance so that it will not load or detune the circuit under test to a degree that will interfere with normal operation.

3. Sufficient audio gain to permit the checking of the lowest audio levels normally encountered.

4. Definite separation between r.f. and audio signals. The r.f. probe must not pass audio, and the audio section must not pass r.f.

5. Power supply with an extremely low hum level and of a type that will permit direct connection from the tracer ground to any receiver chassis. The a.c.-d.c. type of power supply, which would require blocking condensers, and constant care to keep both receiver and tracer chassis on the same side of the line, is *definitely* not suitable.

6. Size as small as possible without sacrifice of efficiency.

7. Headphones rather than a speaker. This will cause less confusion when checking a receiver that is operating with low volume or distortion. The headphones also help to mask the sound coming from the receiver speaker, so that a check of quality and volume level may be made at any particular stage without interference from the receiver output.

8. A volume control. This is necessary to adjust the volume to a comfortable listening level and at the same time helps in making a comparison of signal levels.

The addition of tuned circuits would not only increase the size of the instrument and add to the number of controls, but would not provide any very great gain in usefulness. The selectivity of the circuit under test, if it is not loaded by the test equipment, is great enough to identify the frequency.

## A practical instrument

The circuit diagram shows an attempt to meet the foregoing specifications. There are no trick circuits here—no squeezing the last bit of gain out of the tubes. Input resistances are kept low to minimize the chances of oscillation due to feedback among closely-spaced parts. It is a simple 2-stage, untuned r.f. amplifier, detector, and 2-stage audio amplifier, with headphones to take the place of a speaker.

An r.f. probe is coupled to the first 1T4 grid by a 3-30- $\mu$ f trimmer (set to minimum capacitance under normal conditions). A 1-megohm resistor returns the grid to ground. All tubes have their screens connected to their plates at the socket. This was done to simplify the wiring, but does improve the operation to some extent. Chokes in the plate circuits of both r.f. stages improve the gain. (The increased r.f. impedance of the chokes over that of resistors and their lower d.c. resistance give them considerable advantage in low-voltage circuits.) A 100-250- $\mu$ f condenser couples the plate of the first tube to the grid of the second. Another condenser of the same value is used to couple the plate of the second tube to the diode detector plate. The second r.f. grid is also returned to ground by a 1-megohm resistor.

The audio probe connects to the diode plate end of the volume control through a .005- $\mu$ f blocking condenser. The variable tap on the volume control is connected through a .005- $\mu$ f condenser to the first audio grid, which is returned to ground through a 10-megohm resistor. A 2-megohm resistor connects to the negative side of a 500-ohm resistor that is in series with a B- lead. Output of the 1S4 is through a pair of headphones shunted by a .001- $\mu$ f condenser. A 2-pole switch on the back of the volume control breaks both B+ and A+ leads. The power supply is obtained from 1½-volt A- and 67½-volt B-batteries, of the size commonly used in the new personal portables.

## Construction pointers

The original unit was constructed in a small tinned-metal can—a spice can from the pantry shelf. The tube sockets and components are mounted on a narrow chassis soldered to the inside of the can cover. Long connecting leads are left to run to the volume control, which is mounted on the inside of the can. These leads may be hooked up before the unit is assembled, then folded back

(Continued on page 79)

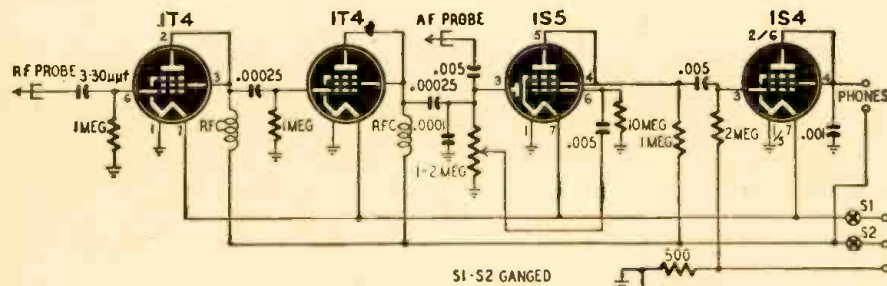

Schematic diagram. Batteries are self-contained. Note that the 1S4 is connected as a triode.

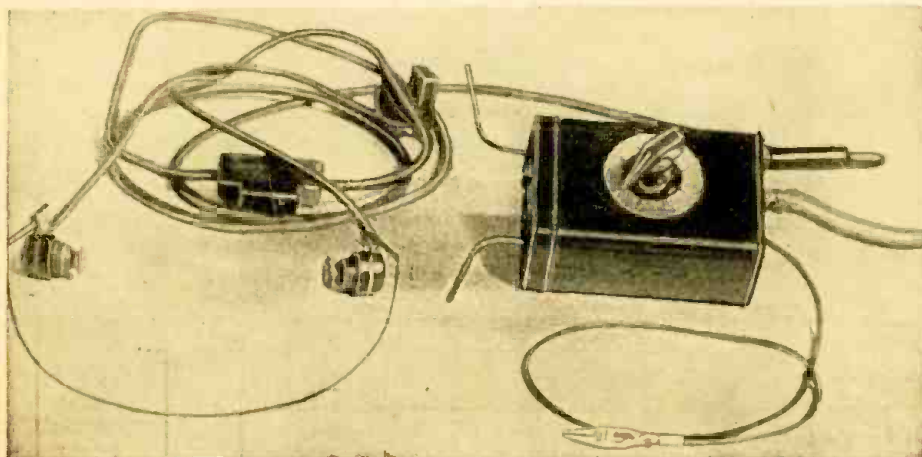

The complete equipment. R.f. and a.f. prods project from one end—phone cord from the other.



# Designing Televisers

## Kit equipment engineering problems

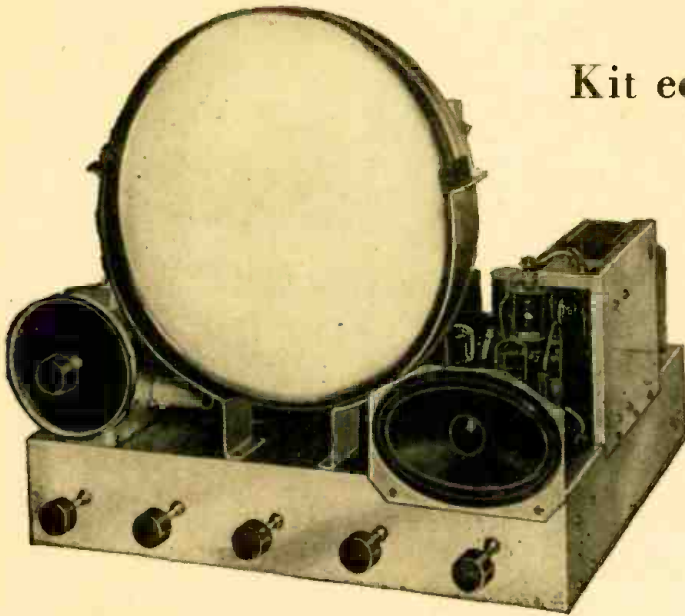

One of the latest receivers designed by Transvision.

**D**ESIGNING a television receiver even for conventional requirements is, of course, a challenging and stimulating problem. But when nontechnical considerations, without the compensating factor of relaxed quality standards, are also present to restrict the engineer, he is definitely up against a situation that taxes his ingenuity to the limit.

This is precisely the dilemma that the Transvision Corporation found itself in by undertaking design of a kit for laymen. Offhand the assignment might appear to be insurmountable, particularly in light of such "unsporting" conditions as alignment procedure that dispenses

tuned before shipment, because of the critical alignment procedure it demands.

The routine service of punching out the chassis is also furnished, but the installation of all remaining components is left exclusively to the constructor. He is supplied, furthermore, with every last item that an efficient television system requires for its optimum performance, including such ultimates as a handsome front panel, a 7-inch *Lectrovision* picture tube, and a sensitive single dipole antenna.

Thus, by following plainly written instructions and clearly drawn diagrams, even the inexperienced builder finds himself smoothly guided, step by step and stage by stage, from rudimentary beginnings to the successful completion of an imposing, modern receiver. When he is finished, he possesses an instrument that physically is 18 inches wide, 18 inches high, and 15 inches long. Electrically it has a band pass of  $3\frac{1}{2}$  mc. The viewing area of 25 square inches not only will comfortably entertain a minimum of 15 people, but the definition and clarity of the pictures themselves have already won considerable praise. Post-war television in general may be de-

scribed as having attained a status equivalent to that of home movies.

scribed as having attained a status equivalent to that of home movies.

The tube lineup in the r.f. section is a 6AC7 mixer and a 6C4 local oscillator. Despite compactness, it is capable of surprising gain. In the video i.f. section there are 3 stages, each using a 6AC7. The audio intelligence is picked off of the second i.f. transformer by a trap tuned to 21.9 mc, and fed into a sound i.f. stage that uses another 6AC7.

A 6SQ7 demodulator-amplifier and a 6V6 power amplifier comprise the audio section. Video detection and amplification are handled by a 6H6 and 6AG7.

The synchronization separator is still another 6AC7, and it fires a 6N7 multi-vibrator in both the vertical and horizontal sweep circuits. The 6SN7's that follow are push-pull amplifiers.

Low-voltage rectification employs a 5U4G, while a 2X2 (or 2Y2) rectifies the high voltages. The picture tube is a type 7EP4.

Perhaps the most striking feature of the i.f. section is the system of fixed, double-tuned trap coupling. This method not only obviates the need for a signal generator, but in spite of the high intermediate frequency it affords satisfactory gain over a  $3\frac{1}{2}$ -mc band pass that is obtained by heavy damping. The only tuning the constructor has to do is to adjust trimmers in the trap circuits. In the second i.f. can, for example, the 21.9-mc trap is simply to be adjusted for maximum audio output, while the 2 remaining trimmers are set for greatest brightness.

The selection of a relatively high intermediate frequency was dictated by image considerations. This choice happily fixes the various image frequencies in channels that, for the present, are inactive, thereby evading this irksome problem despite the inherently poor image rejection power of television receivers in general. Incidentally, even when one makes the reasonable assumption that inevitably these idle frequencies will be used, the situation is not necessarily insecure. Measurements have intimated that, at these high image frequencies, conventional tubes such as the 6AC7 becomes inoperative and in this curious manner introduce acceptable rejection properties.

A noteworthy wiring precaution that preserves i.f. gain at its highest possible level is the use of a single ground for each i.f. stage. This common ground is a lug securely fastened to the appropriate socket under the No. 1 pin. Spuri-

(Continued on page 67)

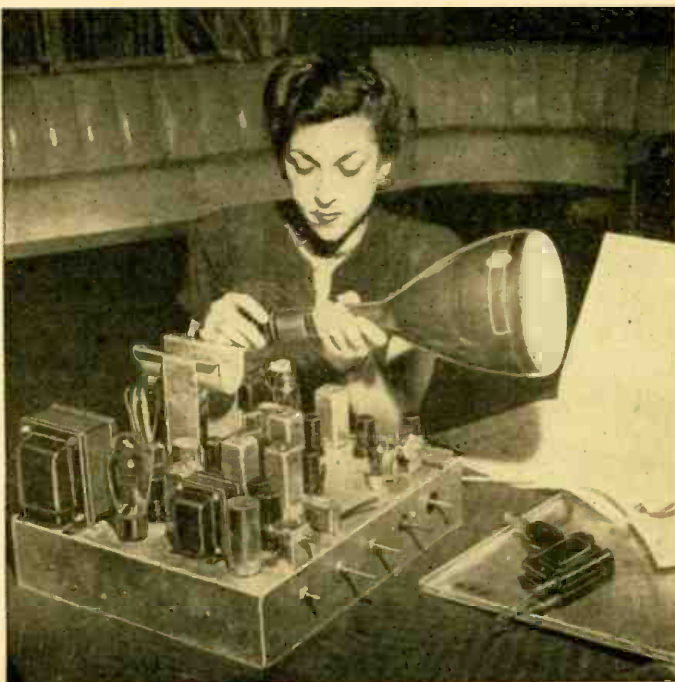

Partial prefabrication makes assembly problems much easier.

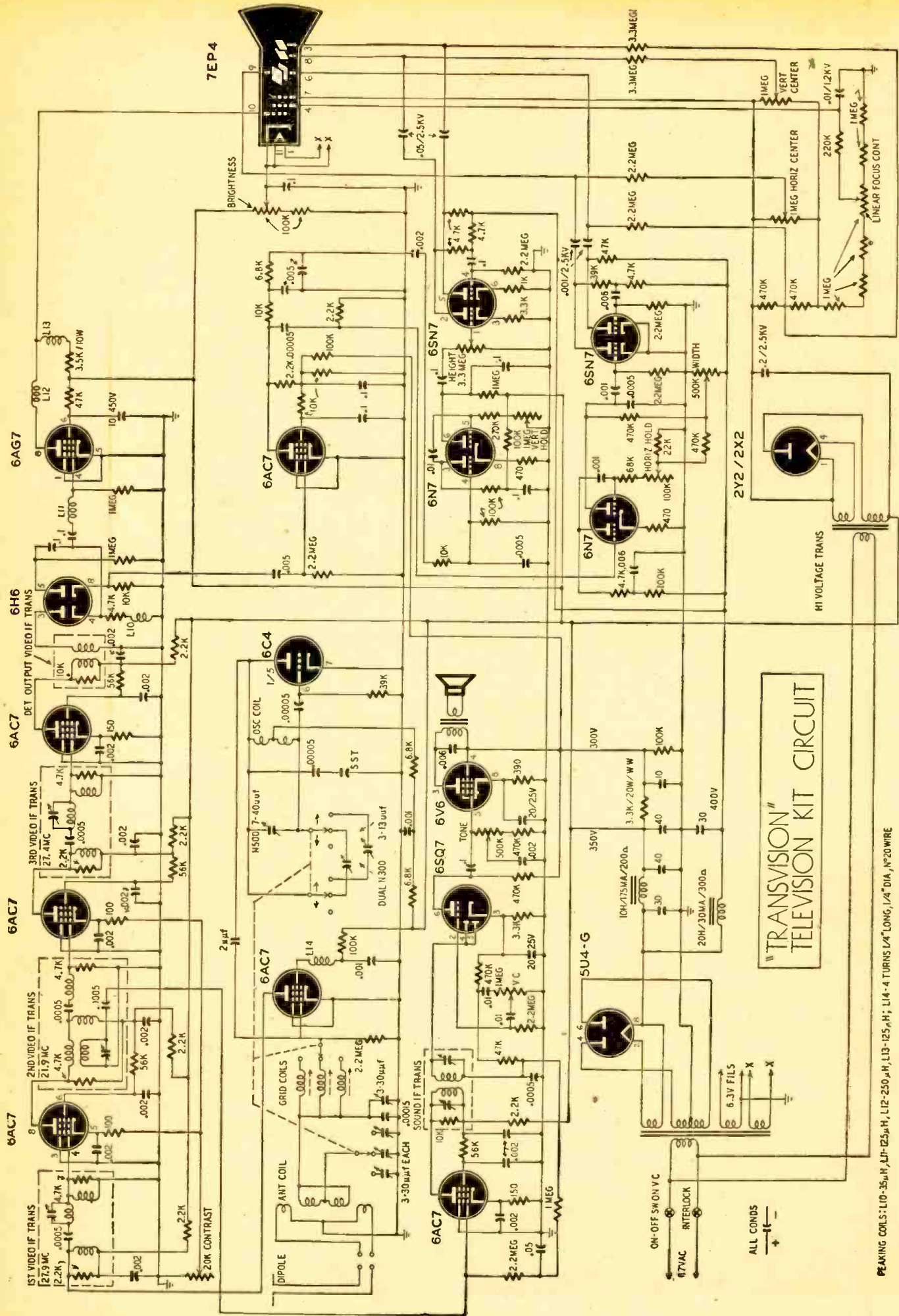

PEAKING COILS: L10-35μH, L11-125μH, L12-250μH, L13-125μH, L14-4 TURNS 1/4" LONG, 1/4" DIA., #20 WIRE

# Transatlantic News

By Major Ralph W. Hallows

RADIO-CRAFT EUROPEAN CORRESPONDENT

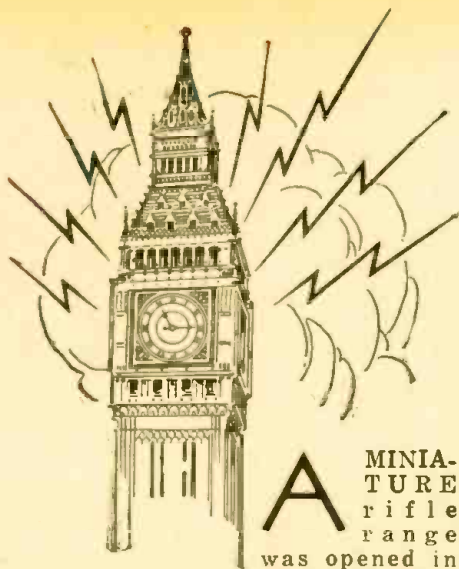

## A MINIA-TURE rifle range

was opened in London the other day by Sir Ian Fraser, M.P., who fired the first 2 shots blindfold. Despite this handicap, both were only a small fraction of an inch outside the bull's-eye. He was followed by the chairman of the National Smallbore Rifle Association, who, also blindfolded, scored a bull's-eye with his very first shot. The .22-caliber rifle range for the blind is the outcome of work by P. B. Nye, chief research engineer of St. Dunstan's training center for the blind, who was no doubt inspired by modern blind-landing systems used in aviation.

The rifle is a standard .22-caliber weapon, the muzzle end of which passes through a metal ring  $2\frac{1}{2}$  inches in diameter. One purpose served by this ring is to ensure that, even if the trigger is pressed inadvertently, no bullet can fail to hit the back-stop at the far end of the range. Imagine now that you are a blind or blindfolded shooter. As you pick up the rifle you hear a sustained note from a loudspeaker. The farther the rifle is sighted from the center of the target, the higher is the pitch of the note. When your aim is "dead on," the

loudspeaker is silent. It is rather reminiscent of the old t.r.f.—plus tickler radio method of tuning in a station by finding the silent point between squeals—and the principle is much the same. Move the rifle until the null point is reached and it is right on the correct line of sight.

Hams who have blind training centers in their localities may care to work out similar apparatus for them. The circuits used have not been published, but if readers would like to have them, I will do my best to obtain all the details.

## N. Y. police stop London Tele!

International incident? In a way, yes. But it's not going to lead to a fight, or even an exchange of diplomatic broadsides. For some time we have been experiencing what is known as the "Harris Tweed effect" on our televisers. It is clearly due to interference of some kind and certain investigators have just claimed to have tracked the cause down to the police radio transmissions in New York! Whether they are right or wrong is not yet known, but I do know that in the present conditions of near-maximum sunspot activity all kinds of queer v.h.f. reception effects at normally impossible ranges are being reported continually.

It used to be believed that the limit range of transmissions made on frequencies of 30 mc and above was not very much greater than the horizon as viewed from the top of the transmitting antenna. We know now that even in normal conditions it is a good deal beyond

that. Further, experience has proved that under the abnormal conditions which accompany a sunspot maximum freak reflection of v.h.f. transmissions may occur from superionized patches in the upper atmosphere. In such circumstances radiations of the order of 5-10 meters may span distances of thousands of miles. I have certainly heard such American transmissions here on more than one occasion and it is therefore not impossible that our Harris Tweed effect is, sometimes at any rate, due to the U. S. police radio.

## The television spy

V.h.f. reception at ranges beyond the quasi-visual is a reminder of a remarkable use made of the French television broadcasts during the war by the British Intelligence Service. It has not until now been permitted to mention it. When the Germans occupied France in 1940, they kept the French television system going, using it chiefly for anti-Allied propaganda purposes. Believing that it was quite unreceivable by the Allies, they regularly used the Paris station to work up feeling against us by broadcasting horror pictures of the devastation wrought by British and American bombing from the air. The British Intelligence Service assigned the well-known radio expert G. T. Kelsey the task of devising apparatus to pick up the broadcasts. At a range of 180 miles strong interference from home radar stations made the problem a difficult one; but by employing a curtain array of 32 dipoles suspended between 150-ft. masts Kelsey was successful. For the last 2 years of the war all the Paris television broadcasts were monitored and the R.A.F. authorities received invaluable information, in the form of actual televised film pictures, of the extent of the damage that they had done. Even the best of secret agents on the spot could not have supplied a tenth of the detailed information thus obligingly sent out by the enemy!

## The audio-frequency range

At a recent meeting of the Royal Society of Arts in London, Sir Ernest Fisk stated that Electrical and Musical Industries, a leading phonograph company, had devised successful methods of recording up to 20,000 cycles on wax discs. Other speakers, including Sir Malcolm Sargent, the great orchestral conductor, expressed the belief that it would ultimately be found that real high-fidelity reproduction could never be obtained unless frequencies far beyond the actual audible range were faithfully dealt

(Continued on page 62)

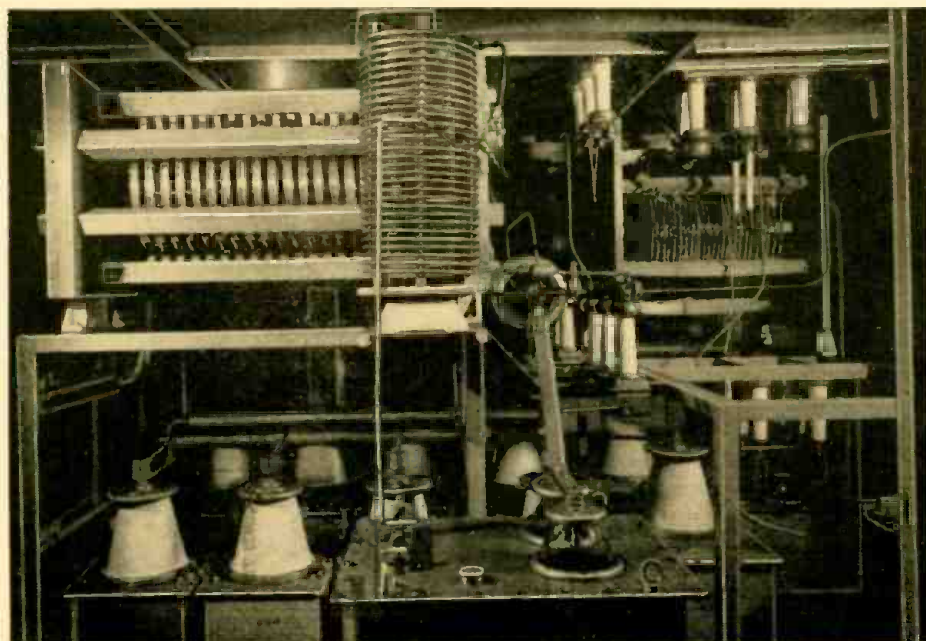

Part of the BBC transmitter at Ottringham, near Hull, England, described in this article.



# BUY from America's STOREHOUSE of QUALITY PARTS

## IRC VOLUME CONTROLS



1000 ohm wire wound midgets - manufacturers close out - 1/4" shaft 3/8" long - list \$1.25 - over 90% off.

EACH **12c**  
 IRC SEALED Box of 252 **24.95**

# RADIO SUPPLY & ENGINEERING CO., Inc.

LOWEST PRICES

125 SELDEN AVE DETROIT 1, MICH.

## SPRAGUE .5 mfd - 300 Volt



That's right - genuine Sprague condensers - manufacturers close out - new fresh stock - size 3/4" x 2 1/2" - tinned leads - all guaranteed.  
 NET EACH **6c** 10 FOR **49c**

## OUTPUT TRANSFORMERS

Clean stocks - long leads - mounting feet - made to fit where you need them.  
 For 6F6-6K6 - to 4 ohm voice coil - size 2" x 1 1/4" x 1 1/4".  
 50L6-35L6-25L6 to 4 ohm voice coil 1 3/4" x 1 1/4" x 1 1/4".  
 Specify quantity of each type you need at.



**49c**

## MULTI-USE WIRE

An old favorite - back again! Stranded No. 22 tinned wire - glass "ROCK BESTOS" 1000 volt insulation - fireproof aircraft wire - a wartime development - at this low price you can use the best.  
 100 feet **45c** 1000 feet **3.89**



## MODEL 451A AC-DC Volt-Ohm - Meter



A dependable instrument of wide utility - sensitivity 1000 ohms per volt. Ranges: Volts AC, DC, and Output Ranges: 0-10/50/100/500/1000. Ohms full scale, 500,000. Ohms center scale, 7200.

NET complete with batteries **14.90**



## MODEL 312 Volt-Ohm - Milliammeter

An economy pocket meter featuring a 2" moving vane meter. Reads: AC-DC volts, 0-.25/50/125/250; Mills AC-DC, 0-50; Ohms, 100,000; mfd. .05-15. Jacks provide range selection.

NET Complete with cord and plug... **6.75**

## JEWELLED PILOT LIGHT ASSEMBLIES

- Miniature bayonet socket
- Mount in 1" hole
- Lamps removable from front of panel
- Available in red, green, or amber - quantities limited - order now.

List Price \$1.30 At RSE'S 85% off - you pay **19c**  
 Back again - by popular demand!



## Pep-Up PHILCO CHANGERS

At last! All the parts you need to restore brilliant tone and volume to "sick" changers! You'll need all three items - sell your customer a 100% reconditioning job -  
 Selenium cell only, no holder **\$1.80**  
 Sapphire needle only, no mirror **\$1.20**  
 Special original equipment lamp **.27c**  
**RECONDITIONING KIT** - all three above items - postpaid - special at **3.21**

## RADIO RULE

Here is a clear 6" plastic rule - a necessity for radio students, draftsmen, hams, all who desire cleaner, more precise work. Nationally advertised at \$2.00. Order yours today postpaid only **35c**



## VOLUME CONTROLS

Our own private brand - made by a nationally known manufacturer - you have this same control on your shelf now - the same kind that net for \$1.09! Standard noise-free carbon construction - 3/8" bushing - 1/4" shaft, 2" long - complete with switch. Ideal all purpose replacement control - individually boxed in our colorful carton carrying the RSE quality seal of approval.

Full range of sizes - with attached switches!

10 M ohms  
 15 M ohms  
 25 M ohms  
 50 M ohms  
 100 M ohms  
 250 M ohms  
 1 Meg. ohms  
 2 Meg. ohms

**59c each**  
**55.00 per 100 assorted**

500 M ohms - less switch 39c ea. 100 for \$35.00

## IRC 10 MEG. 1/2 WATT.

IRC type BTS 10 Meg. 1/2 Watt resistors - manufacturers close-out - clean stock - how can you pass them up at **1c ea.**



## TRIPLET PANEL METERS

Panel meters by Triplett! Top quality instruments - new - boxed - five popular types - priced right - your chance to get those meters you've always wanted.

Model 332 - 0-150 A.C. volts - 3" round flush mounting black brass case.

Model 231 - 0-150 A.C. volts - 2" round flush mounting bakelite case.

Model 233 - 0-150 A.C. volts - 2" round metal case - less mounting clamp.

Model 221 - 0-30 D.C. volts - 2" round flush mounting bakelite case.

Model 324 - 0-400 D.C. volts - 3" round projection mounting - bakelite case.

Model 331 - 0-30 A.C. amps - 3" round flush mounting bakelite case.

Model 322 - 0-150 D.C. volts - 3" round flush mounting black brass case.

Supply limited - order now - list models you desire.

**2.95 EACH**

## PHONO PICKUP CRYSTALS

Standard types - Set Manufacturers close-out - all Guaranteed



Shure P30 - Shure's newest and finest - osmium tipped permanent needle - 1.8 volts output - fits standard mounting holes. List Price \$7.50. You pay us **269**



SHURE P93 - W57A - pin-type terminals - 3/4 oz. pressure, 1.6 volt output - 5000 cycle cutoff. List price \$5.55 - our Special. **198**



Astatic L75 - another new type - 1 1/4 oz. pressure - .75 volt output - 6000 cycle cutoff. List price \$5.55 - 64% off. **198**



ASTATIC L40 - The prewar favorite - used in millions of phonographs - solder terminals - 1 1/2 oz. pressure - .6 volt output - 4500 cycle cutoff. List price \$4.45 - your cost. **198**

## RESISTANCE LINE CORDS



Standard 3 terminal 135 ohm AC-DC cords - sturdy construction, flexible - 5 1/2" long complete with plug - for sets having approximately 69-75.2 volts drop in the filaments. Regular list price 1.17

**Only 33c**

## AEROVOX 8/8/8 - 450



Genuine Aerovox triple 8 mfd. - 450 volts - inverted screw mounting - insulated aluminum can 1 1/2" x 4" - 6" insulated leads - List price \$4.25 - one time only at **89c**

## OZ4 TUBES



New, guaranteed, made by the only maker of OZ4's. Buy now! Hit that car radio business hard - \$2.20 List - 60% or more off - limited quantity.

Egg crate of 100 **79.00**

In colorful RSE box at 88c ea.

## AEROVOX - SOLAR PAPER TUBULARS



Genuine name brand paper bypasses! New, fresh, full capacity standard merchandise - not surplus - all guaranteed! Check the list prices - our low nets - no need to figure the discount - buy 'em now, they've hit bottom!

Mfd.	Volts	List Price	Net Each	Per 100
.01	600	30c	10c	\$ 9.15
.02	600	30c	11c	\$ 9.95
.05	600	40c	14c	\$12.95
.1	600	45c	16c	\$14.95

Quantity Prices not assorted.

## SEND FOR FREE CATALOG



DEMAND THIS SEAL OF QUALITY

## ORDER INSTRUCTIONS

Include full remittance with orders of \$3.00 or less. Include 25% deposit with all C.O.D. orders of \$3.00 or more. All shipments sent express collect if postage is not included. Prices subject to change without notice. BE SURE TO INCLUDE SUFFICIENT POSTAGE. EXCESS WILL BE REFUNDED.

# WORLD-WIDE STATION LIST

Edited by ELMER R. FULLER

**T**HIS month we wish to be a little different. Instead of giving you the good reports first, we will air complaints we receive. First, the difficulty several are having with our time tables. Some have to spend a little time figuring from Eastern Standard to GMT, and then back to local time. And then someone finds that his time is off a half hour instead of an hour from our standards. Well, I am not the one to solve this problem; but it seems that there must be some solution to it. At any rate, we are attempting to use the 24-hour clock on EST. It works this way, midnight is 0000 or 2400 hours; 1 am is 0100; 1:15 am is 0115; noon is 1200; 3 pm is 1500. Several have asked to have this explained again, and this should make it clear to all of our readers. Elsewhere on this page, you will find a chart that will serve as a guide when properly filled in to readily convert EST and GMT to your local time.

Another complaint comes from your editor. Time still needs stressing. Even though there seems to be lots of it, yet we do not have enough. In your reports please state the *schedule* of the transmitters; or if you do not know the schedule, during what time you heard the station. Merely reporting a station as heard is like taking your pants to the cleaners, and then forgetting to go back to pick them up when ready. If you have any doubt about the identity of a station, state this on your report. Perhaps we can help you to identify it, and then again, it may be a mystery to us, so we start looking for it also. Be sure that your report carries time heard if possible, in our system of 24-hour EST.

With that off our chest, let's turn to the reports received for this month. They were good. Gil Harris up in North Adams, Massachusetts sent us 3 reports in the past few weeks. Every one of them was a good one. Gil reports that the station heard on 10.970 mc is PZR in Paramaribo, Surinam and has been heard very fine business at 1700. He also reports hearing a station near 17.840 mc which he thinks is Radio Eireann at Athlone, Eire. They were giving the news in English until 1350 with the sign off at 1353, Brussels, Belgium came on at 1350 warming up their

transmitter for the sign-on at 1355 hours. This station is on 17.840 mc, and may be heard on regular schedule 0600 to 0700, 1100 to 1200, and 1230 to 1500 hours, but this is very irregular, and they may be heard signing on or off at other hours, as Gil reports them doing.

Gil also gives us a 0900-hours view of the 25-meter band. The following have the news in English at that hour; 11.780

11.780 mc using the call ZL3. Any information regarding these or other New Zealanders will be greatly appreciated.

John Winkler reports hearing a station on 7.217 megacycles at 1600 using Latin and Italian. Test transmissions were being made. No information here regarding this. Johnny also reports hearing FGY in Dakar, French West Africa on 7.210 mc, at 1205. Complete schedule of this station is not known here, as it has been off the air for some time, and has only recently returned. OTC in Leopoldville, Belgian Congo is another old-timer who has been giving us pretty constant reception for several years. They are now heard on 9.740 mc from 1300 to 2015.

Received a report from a newcomer this past month. He is Charles C. Edwards of Peabody, Massachusetts. Charley sticks to the ham bands almost exclusively; and I think that we are going to have some real news on these bands for our readers. He uses an HRO-5 receiver for most of his work. He uses a home-made QSL card and it sure gets results for him. In one year he sent out 2410 reports and received replies to about 1200 of them. During the past month he has received California, Connecticut, Massachusetts, Nevada, Oklahoma, Oregon, Washington, and England on 6-meter amateur phone. This is certainly dx for this band, and the kind we like to have reported. During the same period of time, Mr. Edwards received 58 countries on 10-meter phone and 49 countries on 20-meter phone. To date he has heard on 6-meter phone, 2 countries; on 10-meter phone, 69 countries with 32 verified; on 11-meter phone, 3 countries with 1 verified; on 20-meter phone, 87 countries with 54 verified; and on 40-meter phone, 3 countries heard.

If you have any good recent photographs of your receiving station, with or without yourself, we would like to receive them. There is a possibility that they may be used in an early issue. This was done before the war, and will be resumed in the near future. Send all correspondence to Shortwave Editor; RADIO-CRAFT; 25 West Broadway; New York City, 7.

(Continued on page 58)

GMT	EST	Local	GMT	EST	Local
5	0/24		17	12	
6	1		18	13	
7	2		19	14	
8	3		20	15	
9	4		21	16	
10	5		22	17	
11	6		23	18	
12	7	24/0	19		
13	8	1	20		
14	9	2	21		
15	10	3	22		
16	11	4	23		

mc, Saigon, Indo-China; 11.830 mc, XGOA, Nanking, China; 11.840 mc, VLC7, Shepparton, Australia; 11.730 mc, KGEX, and 11.790 mc, KNBA in San Francisco; and 11.650 mc, XTPA, in Canton, China. How many of these can you pull in well enough to identify? All-India Radio is heard to East Asia on 11.870 mc from 0930 to 0942. An Australian heard on 11.760 mc from 0720 to 0800, may be VLC10.

Another report from my old friend, J. B. Yates in Amityville, New York, didn't have any news on short wave other than the fm and television reception in the New York City area. From *Radio & Hobbies* of Australia, we learn that the New Zealand stations have been heard testing, and that they will soon be on the air. This was some time ago, but I have received no report of them being heard in the U. S. as yet. Has anyone heard these newcomers on the air, either on regular transmissions or testing? They are reported to be on 9.540 mc using the call ZL2 and on

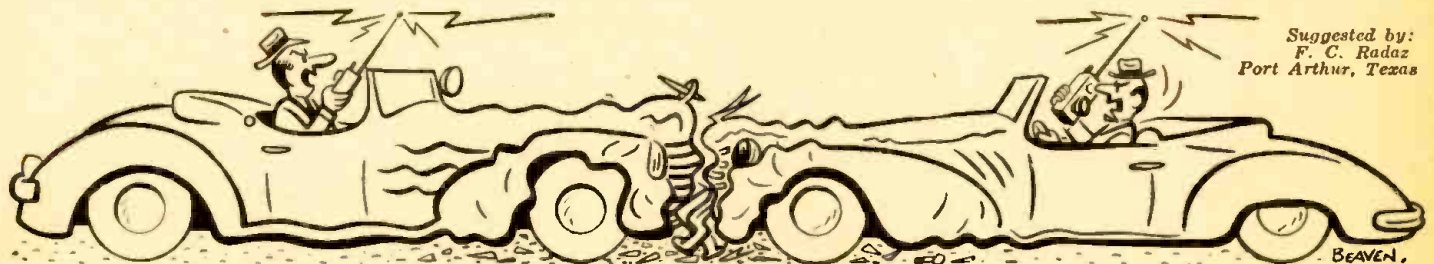

Suggested by:  
F. C. Radaz  
Port Arthur, Texas

D \* ★ ★ D # ? & % ! ! "

D # ★ ★ "\$ ? " % ★ \* : ★ ! ! "



# ALLIED

presents 2 new  
**hallicrafters**  
Communications  
Receivers

## S-53 Communications Receiver

Here's *the* completely modern receiver Hams and SWL'S have been looking for—superbly engineered for top-notch performance—at a remarkable low price. The new Hallicrafters S-53 features extended frequency range, tuning 540 Kc to 54½ mc in 5 bands. Uses 2 mc IF which positively eliminates all amateur station images or repeat points within the ham bands. Features include: accurately calibrated, edge-lighted slide-rule dial; separate bandspread control and scale, with full electrical bandspread; latest series-type noise limiter circuit; voltage-stabilized oscillator; iron-core IF'S; tone control; built-in PM dynamic speaker; phone and phono jacks. Handsomely housed in rich satin-black steel cabinet with satin-chrome trim. Complete with 7 tubes and rectifier. For 105-125 volts, 50-60 cycles AC.

Amateur Net, only

**\$79<sup>50</sup>**

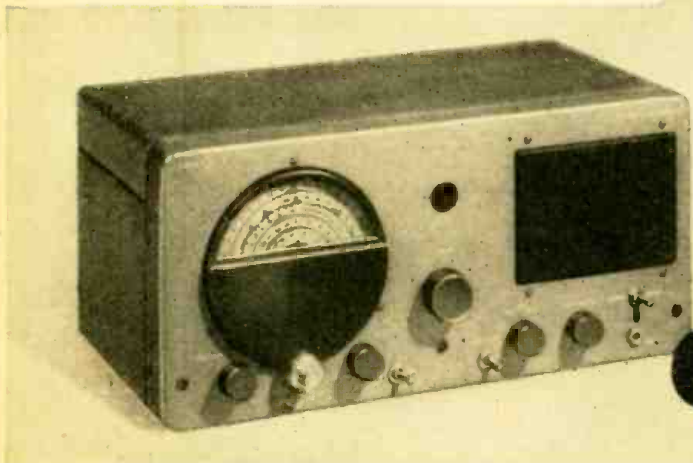

## S-51 "Sea-Farer" Marine Model

Designed and precision-built by Hallicrafters especially for marine use, weather stations, time signal reception, and similar service. Offers 4-band tuning range: 140-400 Kc, 500-1500 Kc, 1500-4400 Kc, 4.4-12 mc. Three additional pre-set frequencies are available; any one fixed frequency between 200 Kc and 300 Kc, and two fixed frequencies in the 2-3 mc band. Has BFO pitch control; automatic noise limiter; tone control; permeability tuned IF'S; universal antenna input; code-phone switch; phone jack. Built-in PM dynamic speaker is water-resistant, in shock-proof mounting. All metal parts plated to resist corrosion. In rich satin-gray steel cabinet. Operates from 105-120 volts AC or DC. (6, 12, or 32 volt power packs available at \$22.50 additional.) Complete with 9 tubes and rectifier.

Amateur Net, only

**\$129<sup>50</sup>**



## YOUR ALLIED CATALOG

## Radio's Leading Buying Guide

Keep your latest ALLIED Catalog handy. It's the complete, preferred Buying Guide to everything in radio at lowest prices! Offers everything in radio and electronic equipment for the serviceman, sound man, engineer, ham, short-wave listener, builder and experimenter. Keeps you up-to-date on the latest equipment. Saves you money on every order. Make ALLIED your Radio Headquarters—it's the established, dependable supply source for America's radio men. Make sure your name is on our mailing list to receive the latest ALLIED Catalog—Radio's Leading Buying Guide.

**Place Your Order with ALLIED Now!**

ALLIED RADIO CORP.  
833 W. Jackson Blvd., Dept. 2-B-8  
Chicago 7, Illinois

- Place my name on your mailing list.
- Enter order for .....
- Enclosed \$.....  Full Payment  Part Payment (Balance C.O.D.)
- Send full information on Communications Receivers and Time Payment Plan, without obligation.

Name \_\_\_\_\_  
Address \_\_\_\_\_  
City \_\_\_\_\_ Zone \_\_\_\_\_ State \_\_\_\_\_



Question Box queries will be answered by mail and those of general interest will be printed in the magazine. A fee of 50c will be charged for simple questions requiring no schematics. Write for estimate on questions that may require diagrams or considerable research. Six to 8 weeks is required to draw up answers involving large schematics.

### 2-HAM BAND PRESELECTOR

Please print a diagram of a 2-stage preselector using 1851's and covering from 200 meters to 10 meters. I have a 2-gang, 140- $\mu$ f variable and a 2-gang, 35- $\mu$ f variable that I would like to use. Please show some method of tracking one of the stages and an r.f. gain control. —D.Y.S., Grosse Point Farms, Mich.

A. Here is a 2-stage preselector that uses ganged tuning on the main and band-spread tuning condensers. An r.f. gain control has been included in the cathode circuits of the tubes. The band-spread condensers may be omitted without impairing the operation of the unit, since r.f. stages tend to tune rather broadly. L2 is used with a 100- $\mu$ f variable condenser, mounted on the panel, to peak the first r.f. stage.

Shields should be used over the r.f. coils and on the plate and grid leads as shown. A grounded baffle or shield should be used between C1 and C2 and between C3 and C4 if the unit oscillates at high-gain settings.

The coils are wound on 1½-inch plug-in forms. Six-prong forms are used for the first r.f. coils and 4-prong forms for the second.

#### COIL DATA

- (200 to 80 meters)  
 L1—15 turns close-wound 5/32 inch below L3  
 L2—32 turns interwound with L3  
 L3—50 turns No. 20 s.s.c.  
 (80 to 40 meters)  
 L1—7 turns close-wound ¼ inch below L3  
 L2—14 turns interwound with L3  
 L3—24 turns No. 18 s.s.c.  
 (40 to 20 meters)  
 L1—6 turns close-wound ¼ inch below L3  
 L2—8 turns interwound with L3  
 L3—11 turns No. 18 s.s.c.  
 (20 to 10 meters)  
 L1—4 turns close-wound ¼ inch below L3  
 L2—4 turns interwound with L3  
 L3—5 turns No. 18 s.s.c.  
 No. 26 s.s.c. is used for winding L1 and L2 on all bands. L4 is wound the same as L2 and L5 the same as L3 for each band.

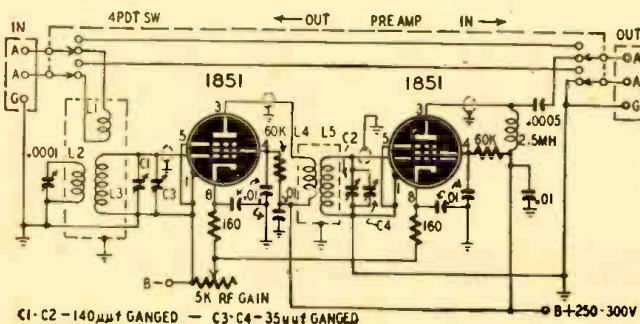

C1-C2-140 $\mu$ f GANGED — C3-C4-35 $\mu$ f GANGED

### 3-WAY PORTABLE

I would like to have a diagram of a 3-way t.r.f. portable radio using a 1T4, 1S5, and 3S4, and a 45Z3. I have a pair of iron core r.f. coils and a 2-gang, 365- $\mu$ f tuning condenser that I would like to use.—A.P., Atlantic City, N. J.

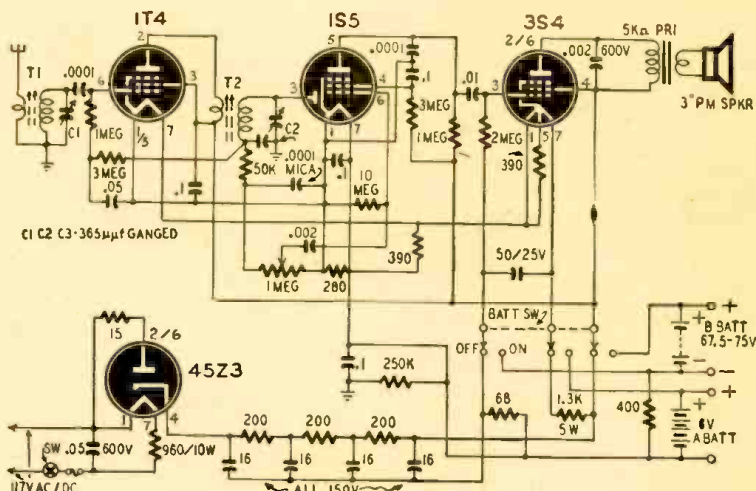

This 4-tube, 3-way portable uses 1 r.f. stage, a diode detector and 2 stages of audio.

A. A diagram of the receiver you specify is shown. A small amount of a.v.c. voltage is applied to the first stage to prevent overloading on strong signals. The output is sufficient to drive a 3- to 5-inch speaker. (All resistors are ¼-watt and condensers rated at 200 volts unless specified otherwise.)

### R.F. POWER SUPPLY

I would like to have a diagram of a 12-kv r.f. power supply using a 6Y6 oscillator and a pair of 8016's as voltage doublers. Is it possible to tap the supply to give 6,000 volts simultaneously?—A.J.L., Brooklyn, N. Y.

A. Data and a circuit for construction of a 12-kv r.f. power supply are given. The high-voltage coil L2 should give

Left — Preselector for ham bands. Right—12-kv r.f. power supply using a voltage doubler. Intermediate voltage is also provided.

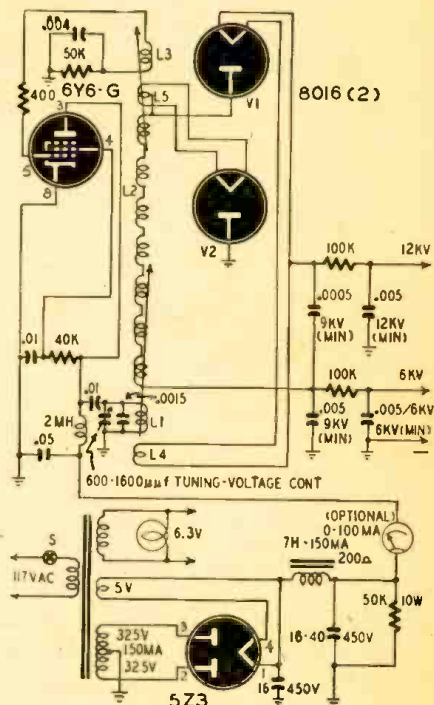

# WE WERE SWAMPED!



Of course we expected a large response when we first announced our new model 247 Tube Tester at the sensationally low price of \$29.90 in the November issue of this publication but we were not prepared for the very large number of orders received. Fortunately we were able to quickly expand our production facility to meet the unprecedented demand and all orders were shipped within a few days after receipt. We take this opportunity to thank the many dealers, schools, experimenters, etc., who favored us with orders for this new model also for their many kind letters.

## THE NEW MODEL 247 TUBE TESTER

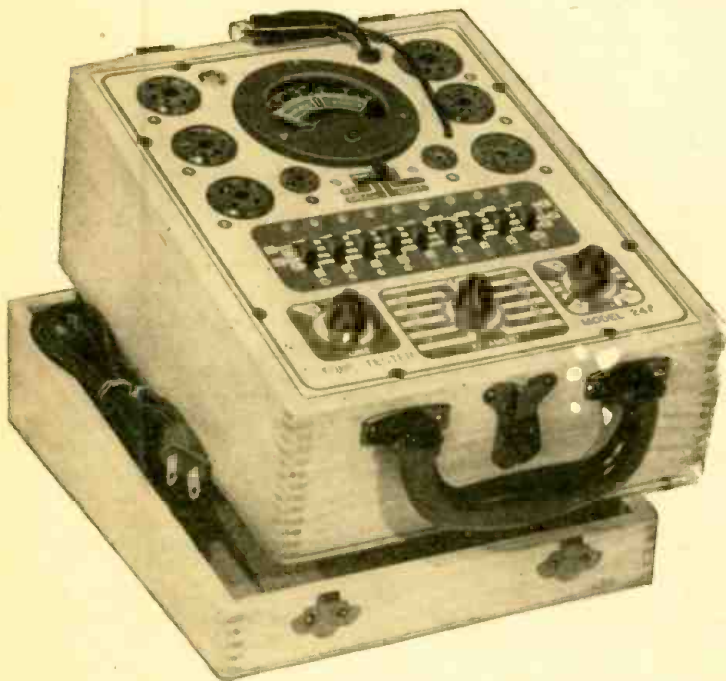

The Model 247 provides a super sensitive method of checking for shorts and leakages up to 5 Megohms between any and all of the terminals. Continuity between various sections is individually indicated. This is important, especially in the case of an element terminating at more than one pin. In such cases the element or internal connection often completes a circuit.

One of the most important improvements, we believe, is the fact that the 4 position fast-action snap switches are all numbered in exact accordance with the standard R.M.A. numbering system. Thus, if the element terminating in pin No. 7 of a tube is under test, button No. 7 is used for that test. This feature will be appreciated especially by servicemen who, when using other tube testers, have been compelled to first try various positions to locate the correct element and then have had to look up charts in order to learn which pin is used for that particular element.

20% deposit required on all C.O.D. orders

### MOSS ELECTRONIC DISTRIBUTING CO.

DEPT. RC-2, 229 FULTON STREET, NEW YORK 7, N. Y.

Tests yesterday's tubes, today's tubes and tomorrow's tubes. The Model 247 features a newly designed *element switching system* designed to accommodate all future tubes as they are announced.

It is impossible to insert the tube in the wrong socket when using the new Model 247. Eight separate sockets are used, one for each type of tube base made. If the tube fits in the socket it can be tested.

The Model 247 incorporates a newly designed element selector switch system which reduces the possibility of obsolescence to an absolute minimum. Any pin may be used as a filament pin and the voltage applied between that pin and any other pin, or even the "top-cap". Please note this is not a variation of the commonly used "floating-filament" arrangement but instead represents a real advance in design, inasmuch as it provides a true "free-point" system. Tubes having tapped filaments and tubes with filaments terminating in more than 1 pin are truly tested with the Model 247 as any of the pins may be placed in neutral position when necessary.

The new free-point system described above permits the Model 247 to overcome the difficulties encountered with other emission type tube testers when checking Diode, Triode and Pentode sections of multi-purpose tubes, because sections can be tested individually when using the new Model 247. The special isolating circuit allows each section to be tested as if it were in a separate envelope.

*Model 247 comes complete with new speed-read chart. Comes housed in handsome hand-rubbed oak cabinet sloped for bench use. A slip-on portable hinged cover is included for outside use. Size: 10 $\frac{3}{4}$ " x 8 $\frac{3}{4}$ " x 5 $\frac{3}{4}$ ".*

ONLY  
\$ **29<sup>90</sup>**

Special  
Quantity  
Prices



complete \$42.95  
NET

Last Chance to Buy . . . .

# TRANSMITTER-RECEIVER

for Amateurs • Experimenters • Radio Students • Schools

Three large packing cases full of equipment includes:  
Two complete transmitters and two complete receivers covering the 2 to 8 megacycle and 235 megacycle bands. Also complete inter-com unit with three remote control stations, cable, connectors, extra head sets and push-to-talk microphones, all equipped with latest type dynamic units.

Also included: Dual voltage, completely filtered 12 volt dynamotor, antenna resonator, extra antennas, 15 spare tubes in addition to those included with set, spare parts, mounting brackets, hardware, blueprints, instructions, etc. **\$42.95 Complete** 25% deposit on C.O.D. orders. (Orders from Michigan add 3% Sales Tax.)

**HOOVER INDUSTRIES 9701 Bryden Avenue, Detroit 4, Mich.**

ted altogether. Without it FM broadcasts will contain very strong high frequencies which result in very crisp speech, and loud rendition of violins and other instruments whose output contains strong high-frequency components.

The r.f. section is assembled within a 3 x 3½-inch area so that an auxiliary 4 x 4-inch steel chassis may be placed around it for shielding. The small chassis has 4 sides and mounting flanges to screw it down to the main chassis, but no bottom. A hinged cover completes the shielding at the top. Both coils and the r.f. and detector tubes as well as the tuning condenser are within the shield.

A double-gang 15-μf condenser tunes the set. To simplify tracking problems a small 10-μf variable shunts the r.f. condenser. Trimmer may be seen mounted below the chassis at the right side.

## Making the coils

Detector and r.f. coils are wound on 5-prong, Amphenol, ¼-inch-diameter polystyrene forms with No. 22 enameled wire. Detector coils are tapped at approximately center. Each coil has a separate primary winding because this is a more flexible arrangement.

Very short leads are important at these frequencies. The location of tubes and coil sockets has a lot to do with this. We have placed the r.f. coil and tube to the right of the ganged condenser, and the other coil and tubes to the left. This gives good isolation of the stages. Note that the coils are in front of the tubes. The front section of

## 1-10 METER RECEIVER

(Continued from page 23)

the ganged condenser tunes the r.f.

The 4 bands covered are listed in the coil table. Above 80 mc it was found necessary to use a special procedure in winding coils. At these high frequencies a single turn or two would have had to be used. To get a reasonable number of turns these coils are wound *within* coil forms and have a ¼-inch diameter. The primaries and all other secondaries are wound *over* the forms.

The coils wound over the forms should give no unusual trouble but the ¼-inch coils are best made as follows: Wind them (as specified in the coil table) around a dowel or pencil, remove, then tin the leads, leaving a length of about ¾ inch. The detector coils will require an added tap lead near the center. Now these air-wound coils are inserted (vertically) directly into the coil sockets and the correct frequency range obtained by compressing or ex-

panding the turns. When this is done, the coils are removed from the sockets and placed permanently in the coil forms. Arrange and space the leads to fit the pins of the coil form, then force the coil slightly into a pencil or dowel, thus giving it a long handle by which it may be lowered into the form. A slight twist of the pencil disengages it.

Soldering to the pins of a polystyrene form for the first time is not an easy matter. The polystyrene softens with heat and the whole coil form can be ruined unless soldering is very carefully done. After several tries we finally hit upon the following as the best method. Place the form upside down in  
(Continued on page 63)

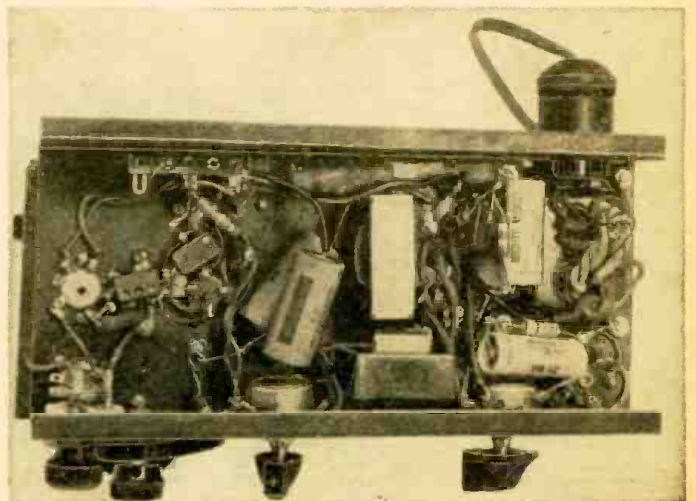

Bottom view of the set.

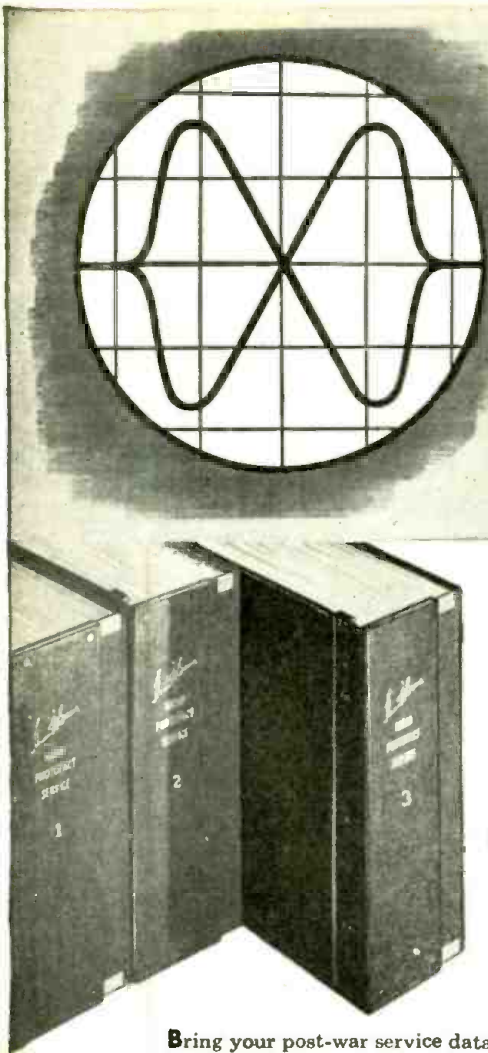

# EXCLUSIVE IN PHOTOFACT Oscilloscope Wave Forms!

## 2 Alignment Procedures for All FM Receivers!

EXCLUSIVE! PHOTOFACT now brings you both professional methods for aligning FM receivers—the "visual" oscilloscope method, and the meter method using an AM generator and vacuum tube voltmeter. PHOTOFACT Folders now include large, clear, specially prepared diagrams of actual oscilloscope wave forms for each visual alignment described. These wave forms show you how to secure absolute maximum circuit performance in minimum time. This revolutionary development, available in no other radio data service, has been acclaimed by servicemen everywhere since its first appearance in PHOTOFACT Set No. 28, published in November 1947. Here's more powerful proof that you can't afford to be without PHOTOFACT—the complete, practical, profitable radio data service.

*Howard W. Sams*

## World's Most Practical Radio Service Data

Bring your post-war service data library right up to January 1948! PHOTOFACT Volume 3 is ready for you—companion to Volumes 1 and 2—the most accurate and complete Radio Data ever compiled. Here is everything you need for fast, efficient, profitable servicing—bound in easy-to-use volumes. Large size schematics with the exclusive PHOTOFACT Standard Notation; photo views keyed to parts lists and alignment data; complete listings of parts values and proper replacements; alignment, stage gain, circuit voltage and re-

sistance analysis; coil resistances; dial cord stringing; disassembly instructions; record changer analysis and repair data. Send in your order today for PHOTOFACT—the only Radio Service Data that meets all of your actual needs!

- VOLUME 1. All post-war models up to Jan. 1, 1947.
- VOLUME 2. Models from Jan. 1, 1947 to July 1, 1947.
- VOLUME 3. Models from July 1, 1947 to Jan. 1, 1948.

YOUR PRICE, EACH VOLUME, IN EASY-TO-USE DELUXE BINDER... **\$18<sup>39</sup>**

### INDUSTRY ACCLAIMS NEW HOWARD W. SAMS MANUALS

**Servicemen:** "Terrific is the only word that adequately describes both books. Absolutely "musts" for servicemen."—S. L., Chicago.  
"I think your AUTOMATIC RECORD CHANGER MANUAL and DIAL CORD books are great!"—H. O., Maquota, Iowa.

**Manufacturers:** "Your Record Changer Manual is one swell book. Should be very well received among the trade."—Astatic.

"The Record Changer Manual is a commendable job. Subject is well-covered."—Jensen.

"We have received copies of your AUTOMATIC RECORD CHANGER SERVICE MANUAL and DIAL CORD GUIDE. A great deal of hard work and thorough analysis has gone into the making of these two books. They should certainly fill an urgent need in the service industry. Extremely easy to read and should prove most helpful to our service dealer customers."—Sylvania.

"Your Record Changer Manual is beautifully prepared. Our compliments to you and your organization."—Webster-Chicago.



### SPECIAL OFFER

If you haven't a complete file of all PHOTOFACT Folder Sets to date, you can trade in the individual Folder Sets you now own for complete Volumes at amazingly low cost. Write today for special offer, stating what Sets of Folders you now own (use coupon below).

### BOOST YOUR EARNING POWER!

Mail This Order Form to HOWARD W. SAMS & CO., INC. 2924 E. Washington St., Indianapolis 6, Indiana.

My (check) (money order) for \$..... enclosed.

- Send PHOTOFACT Volume 3 (including Sets Nos. 21 through 30) in DeLuxe Binder, \$18.39.
- Send Volume 2.  Send Volume 1 (each in DeLuxe Binder, at \$18.39 per volume).
- Send... SAMS' 1947 AUTOMATIC RECORD CHANGER MANUAL(S) at \$4.95 each.
- Send... SAMS' DIAL CORD STRINGING GUIDE(S) at \$0.75 per copy.
- Send FREE PHOTOFACT Cumulative Index.
- Send details of your Special Trade-in Offer. I own PHOTOFACT Sets Nos.....

Name.....

Address.....

City.....State.....

HOWARD W. SAMS & CO., INC.  
INDIANAPOLIS 6, INDIANA

Export—Ad. Auriema—89 Broad St., New York 4, N. Y.—U. S. of America  
Canada—A. C. Simmonds & Sons, 301 King St. East—Toronto, Ontario

## PHOTOFACT SERVICE

"The Service that pays for itself over and over again"

**NEW**

# RADIO-ELECTRONIC DEVICES

## CAPACITANCE BRIDGE

Sylvania Electric Products Inc.  
New York, N. Y.

The Type 125 capacitance bridge is useful in measuring interelectrode capacitances in vacuum tubes, provides a range of 0 to 100µmf through the use of 5 multiplier ranges and measurement at 465 kc. Direct capacitance accuracy of 1% and direct conductance accuracy of 10% are provided when calibrated with standards of equal accuracy.



The bridge consists of 3 separate sections including r.f. signal generator and power supply; r.f. amplifier, detector, and vacuum-tube voltmeter and associated switches, controls and a 500-µa meter indicating bridge balance. Ground-to-lead or jig capacitance may be tuned out when combined values do not exceed 25µmf. Special tube-tester adapters are available for measurements with or without base shield or metal shell connected to tube element or ground.

The bridge is rated at 45 watts, 110-120 volts, 50-60 cycles a.c.; weighs 50 pounds; and measures 18 inches long and 12 1/4 inches high. Tube complement includes 5Y3G, 7A6, 7B4, 6C3, and two 7A7's.—RADIO-CRAFT

## WIRE RECORDER

Electronic Sound Engineering Co.  
Chicago, Ill.

The Polyphonic Sound wire recorder is specifically designed for use in the home, broadcasting and recording studio, the school or church. The built-in 6-inch speaker, with a range up to 10,000 cycles, has a special diaphragm to insure smooth reproduction of high frequencies. A 15-inch, dual-channel auxiliary speaker is available. This speaker connects with a jack on the front panel and carries the lower range down to 50 cycles.

Input facilities consist of a low-level



input for a microphone and a front-panel input arrangement for high-level sound from radio or record player. The microphone has a response of 60 to 10,000 cycles. Standard equipment includes a 15-minute spool.—RADIO-CRAFT

## SPOTLIGHT SOLDERING GUN

Weller Mfg. Co.  
Easton, Penna.

A new soldering tool with a handy spotlight tip has just been announced. The small spotlight, placed between the terminals of the loop tip, keeps the

work always in plain sight, even when the tip is flexed to suit a job, the light goes on when the trigger switch is pressed to heat the gun. Five-second heating makes the tool ideal for intermittent duty.

The tool draws 100 watts from 110-



volt, 60-cycle lines. Two models are available—one with a single heat of 100 watts; the other has a dual heat control, with 100 watts normal heat and a 35% instantaneous reserve heat.—RADIO-CRAFT

## AUDIO FREQUENCY METER

Barker & Williamson, Inc.  
Upper Darby, Penna.

The Model 300 audio-frequency meter offers an accurate means of making direct measurements of unknown audio frequencies up to 30,000 cycles. Among other applications, the instrument is useful for checking audio oscillators or tone generators. Six frequency ranges



cover from 0-100, 300, 1,000, 3,000, 10,000, and 30,000 cycles, respectively.

Sensitivity is a minimum of 0.5 volt input. The frequency meter will operate on any wave form with peak ratios of less than 8 to 1. A 3-inch fan-type meter with 2 scales provides easy visibility. The power requirement is 110 v., 60 cycles, 50 voltamperes. The unit is in a black crackle-finished steel cabinet with carrying handle and rubber feet. Dimensions are 13 3/4 X 7 1/4 X 9 1/2 inches, and the weight is 19 1/2 pounds.—RADIO-CRAFT

## SILVER PLATE COMPOUND

General Cement Mfg. Co.  
Rockford, Ill.

The new Silver Plate Compound is used for plating worn contacts, and newly made contacts and for replacing worn silver plating on all types of metals. The compound comes in bottles.

Carbon Control Cleaner is another new product of the same manufacturer. It cleans carbon controls without the set being removed from the cabinet. The chemical removes oxidation and coats the contacts to minimize future trouble. An applicator comes with each bottle.—RADIO-CRAFT.

## TEST BENCH

Radio Tube Division  
Sylvania Electric Products  
New York, N. Y.

Providing ample area for benchwork, the new fixture includes sloping panel for permanent mounting of meters, prod test outlets, tube testers and other tools. Suitably proportioned drawers for dust proof storage of oscilloscopes, vacuum tube voltmeters

and other valuable test instruments are provided.

The seven-foot bench top is covered with durable linoleum for improved appearance and protection of delicate equipment and components. Four shallow drawers provide out-of-sight storage for frequently used component, push-back wire and small hand tools. Knee-hole and recessed base design permit working close to the bench with drawers handy while working in



either standing or sitting position. Sloping panel tends to eliminate glare from instrument dials and accidental damage to mounted and portable equipment.

The test bench is available in knock-down, unpainted form.—RADIO-CRAFT

## MULTIMETER

Triplett Electrical Instrument Co.  
Bluffton, Ohio

The Model 66-HH volt-ohm-milliammeter is a compact multirange instrument with a 3-inch meter with red and black scale markings. Voltage ranges, a.c. and d.c., are 0-10-50-250-1,000-5,000 volts at 1,000 ohms per volt. Direct-current ranges are 0-10-100-500 ma. Two resistance ranges are provided for measurements up to 400,000 ohms.—RADIO-CRAFT

## HEARING AID HELP

Beltone Hearing Aid Co.  
Chicago, Illinois

The Selectometer is designed to enable a deafened person to choose his own hearing aid. It allows the fitter the opportunity of testing the hard-of-hearing person with more than 140 different combinations of acoustical gain, power output, and frequency response so that the person being fitted actually selects for himself the precise com-



bination of tubes, receivers, and electronic circuits with which he hears best.—RADIO-CRAFT

## SIGNAL TRACER

Feiler Engineering Co.  
Chicago, Illinois

The model TS-5 Pocket Stethoscope signal tracer is comparable in performance to bench-type models TS-2 and TS-3. It has the extra advantage of



being small and light enough to take out on the job. Size: 4 1/8 inches wide, 2 3/8 inches deep and 8 3/4 inches high. Weight only 3 1/2 lbs. complete.

Stethoscopes contain their own PM dynamic speakers but provisions are also made for headphone operation. Any standard type volt-ohm milliammeter may be plugged into convenient jacks to make an effective r.f. vacuum tube voltmeter. The Model TS-5 instrument operates on 115 volts a.c.—RADIO-CRAFT

## TERMINAL BLOCK KIT

Curtis Development & Mfg. Co.  
Chicago, Illinois

A new terminal block kit expressly designed for experimental work and maintenance operations. Any number of terminals, from one to fourteen, can be quickly and inexpensively produced. These terminal blocks are similar to factory built blocks and equally substantial.

This individual "build up" feature is suited for electrical engineers and others doing experimental work who



need "one of a kind" part or parts in small quantities for their projects.

Kit No. 200 contains necessary molded sections, terminals and screw assemblies, and Kit No. 201 has a balanced supply of end brackets, partitions, threaded rods, screws, nuts and washers.—RADIO-CRAFT

## DYNAMIC MICROPHONE

Electro-Voice, Inc.  
Buchanan, Michigan

A new high fidelity moving-coil dynamic microphone, the E-V 635 is omnidirectional below 2000 cycles, becoming directional at higher frequencies. Wide frequency range (60-13,000 cycles plus or minus 2.5 db) conforms to modern FM as well as AM standards. Response is substantially flat out to 13 kc. Output is -53 db. Recessed



impedance-selector switch in the microphone stud permits ready choice of 50 or 250 ohms impedance in the one microphone.—RADIO-CRAFT



## PULSE CODE MODULATION

(Continued from page 30)

The quantizing feedback is considerably stronger than the quantizing bias, and forces the beam downward. The result is that the beam travels across the tube with its upper edge against the wire just above its path, and resists any force tending to make it move down or up.

The electrons which go through the slots in the aperture plate are picked up by the *pulse plate* and delivered as code groups of pulses to the amplifiers, gating and slicing circuits which work them over into perfect shape and time them exactly for the transmitter, which sends them into space as perfect code groups of exactly uniform amplitude and spacing.

### The receiver circuits

Detecting — or decoding — PCM impulses is harder than demodulating any other form of pulse transmission. Pulse amplitude signals can be treated like any other form of amplitude modulation — greater input voltages produce comparatively greater output signals. Neither is it hard to make the output of a detector increase or decrease as a pulse moves toward or away from a zero-signal position. But PCM sends out an apparently random combination of impulses, whose position apparently cannot so easily be resolved into variations of output in a detector circuit.

The randomness of PCM signals is only apparent. A pulse may have any value from 1 to 64 according to its position (Fig. 5) and combinations of pulses which form a code character may have values from 1 to 127. These numbers become actual quantities of electricity in the detector circuit.

The decoder is constructed around a condenser which is given a charge by each pulse in the code group. Its rate of discharge is timed so that exactly half its charge leaks off during each pulse interval. Thus, if the code group 1-0-0-0-0-0-0 is received, the condenser is charged in position 1, drops to half charge in position 2, then through  $\frac{1}{4}$ ,  $\frac{1}{8}$ ,  $\frac{1}{16}$ ,  $\frac{1}{32}$  and  $\frac{1}{64}$  charge in succeeding positions till at the instant of output it is a pulse of  $\frac{1}{128}$  its original value (1 quantum). A pulse received in position 2 would reach the output with  $\frac{1}{64}$  its original value (2 quanta) and in the last position would be interpreted by the output circuit as  $\frac{1}{2}$ , or 64 quanta. The decoder reverses the coding process and puts out for each code group the same number of quanta as the signal which produced it. Fig. 10 shows quanta of 64, 1 and 82.

### Other interesting circuits

There are other circuits, which cannot be described in what is actually a short summary of the pulse coding process. Many of these are very interesting, such as the electronic sampling switches, diodes or triodes whose near-infinite resistance drops to near zero for part of a microsecond when triggered by a sharp

*For the Finest  
Phonograph Performance Ever Achieved . . .*

*Newcomb*

## ANNOUNCES 2 GREAT NEW PHONOGRAPH AMPLIFIERS

with the **MAGIC RED KNOB**

**L**OGICAL culmination of years of electronic research and engineering development continuously carried on in Newcomb laboratories, these new phonograph amplifiers, used in conjunction with suitable accessories, will produce unbelievable realism from recorded music or from AM-FM radio tuners connected to them. Their improved response at low volume, their beautifully clear, undistorted treble tones and the exclusive new "Magic Red Knob" control, which virtually eliminates surface noise and distortion from records in any condition, make these two amplifiers the best possible choice for those custom phonograph installations.

**MODEL KXLP-30:** Its ample power permits use of the famous Newcomb KX-Series dual tone control circuit, which provides tonal range and balance unattainable in less costly circuits. This circuit allows controlled emphasis of the desirable but power-consuming fundamental bass tones, avoiding emphasis of harmonic bass, so unacceptable to discriminating listeners.



**MODEL HLP-14:** Brings to music lovers an entirely new listening pleasure in a somewhat less expensive unit than the superb KXLP-30. Exceptional tonal balance at whisper volumes is a feature of the HLP-14. Its adaptability to use with the new AM-FM tuners, wide range loudspeakers and new phonograph pickups make it an ideal starting point for those increasingly popular custom installations.



*Newcomb*

## AUDIO PRODUCTS CO.

Dept. C, 6824 Lexington Avenue • Hollywood 33, California

*Send for Specifications*

signal from a pulse transformer. The synchronizing circuit which in effect steals a digit of one of the pulse groups to use as a signal which keeps the receiver in step with the transmitter is another very important and interesting circuit. Timing oscillators, slicers and gates all are needed to open and close circuits, time and shape the pulse, and possibly most important of all are the regenerating circuits which build up new and fresh code groups from the beaten-up signals which arrive from the last relay station and send them on their way in exactly the form they left the first transmitter. This is the feature which may make PCM the universal form of modulation on future commercial microwave communication circuits.

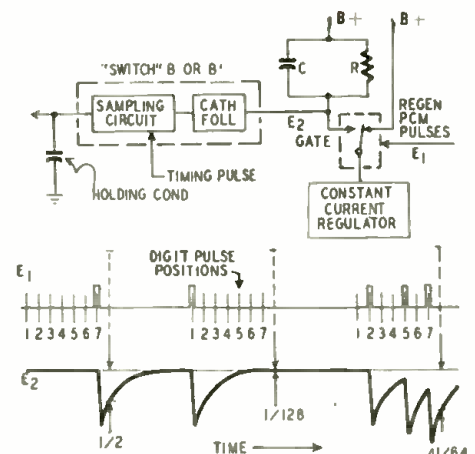
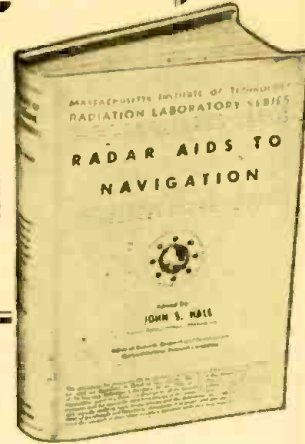

Fig. 10—Turning code signals back to quanta.



# ANNOUNCING-

## the first 13 volumes of the Massachusetts Institute of Technology RADIATION LABORATORY SERIES NOW AVAILABLE



These important books are the first available of the Massachusetts Institute of Technology Radiation Laboratory Series. The Series, containing in all 27 titles and index, was written and edited principally by members of the Radiation Laboratory maintained during the war for electronic research. This outstanding addition to the literature of the field covers advances in radar work—makes these available to all fields concerned with the new electronics—communication, television, biological and physical sciences and the many industries in which electronics is becoming increasingly important.

### RADAR SYSTEM ENGINEERING

**VOL. 1.** Edited by L. N. RIDENOUR, Professor of Physics, Univ. of Penn. 408 pages, over 300 illus. \$7.50

This volume outlines general principles of radar systems, and discusses basic design considerations. It describes the components of a radar set from the design engineer's standpoint and outlines the problems encountered. Moving target indication and radio transmission of data to remote indicators are carefully explained, including detailed examples of actual systems.

### RADAR AIDS TO NAVIGATION

**VOL. 2.** Edited by John S. HALL, Assoc. Professor of Astronomy and Physics, Amherst College. 389 pages, illus., \$5.00

Describes the advantages and limitations of the use of radar in navigation and pilotage. In addition to full treatment of airborne, shipborne, and landbased radar, this book contains descriptions of many other navigation devices which give a more comprehensive picture of the equipment in use. It emphasizes the practical application of modern aids for safety and accuracy in navigation.

### RADAR BEACONS

**VOL. 3.** Edited by ARTHUR ROBERTS, Assoc. Professor of Physics, State Univ. of Iowa. 409 pages, illus., \$6.00

This comprises a survey of the design and latest developments in radar responder beacons and their use in navigation and identification. Information on practical aspects—installation, operation, and maintenance—is included. It describes various types of beacons and interrogators and shows how each is employed in communication, navigation and positioning.

### LORAN

**VOL. 4.** J. A. PIERCE, Research Fellow, Cruft Laboratory, Harvard; A. A. MCKENZIE, Assoc. Editor, Electronics; and R. H. WOODWARD, Research Fellow, Cruft Laboratory, Harvard. 468 pages, illus. \$6.00

A complete account of the design and use of the long-range pulse navigation system known as Loran, both in its original form and as sky-wave synchronized Loran. Sections are included on radio propagation at Loran frequencies and on methods for the computation and preparation of Loran navigational charts.

### PULSE GENERATORS

**VOL. 5.** G. N. GLASCOE, Rensselaer Polytechnic Institute; and J. V. LEVACQZ, Johns Hopkins Univ. 737 pages. \$9.00

The theoretical and practical aspects of the generation of power pulses. Pulse powers in the range of 100 watts to 20 megawatts and pulse durations from .05 to 10 microseconds are considered, covering pulse formation, the effect of circuit parameters on the pulse shape, pulse power, average power, power transfer, and circuit efficiency.

### KLYSTRONS AND MICROWAVE TRIODES

**VOL. 7.** Edited by D. R. HAMILTON, Princeton Univ.; J. K. KNIPP, Iowa State College; and J. B. H. KUPER, Brookhaven National Laboratory. 534 pages, illus. \$7.50

An authoritative discussion of low power microwave triodes, klystrons, and their performance as local oscillators, signal generators, and low-power transmitters. It explains fully the theory behind the use of klystrons and triodes as mixers, amplifiers, oscillators, and frequency multipliers. Two-cavity and reflex klystrons and planar triodes are described.

### MICROWAVE MIXERS

**VOL. 16.** By R. V. POUND, Junior Fellow, Society of Fellows, Harvard. 381 pages, illus. \$5.50

A specialized treatment of the microwave portions of very high-frequency receivers, discussing various receiving systems and their relative merit. Design problems of practical mixers are carefully described, showing how to maintain constant absolute frequency of local oscillator and how to stabilize constant frequency difference between transmitter and local oscillator.

### MICROWAVE RECEIVERS

**VOL. 23.** Edited by S. N. VAN VORHIS, Assoc. Professor of Physics, Univ. of Rochester. 611 pages, illus. \$8.00

This book treats together all the elements making up a wide-band receiver, describing individual circuit types—the assembly, testing, and maintenance of microwave receivers. It includes analyses of actual receivers which contain examples of important circuit combinations.

### THEORY OF SERVOMECHANISMS

**VOL. 25.** Edited by H. M. JAMES, Purdue Univ.; N. B. NICHOLS, Taylor Instrument Co.; and R. S. PHILLIPS, Univ. of Southern Calif. 375 pages, illus. \$5.00

Outlines the standard theory of servomechanism design, showing application of current techniques, and providing an introduction to a new technique. It covers frequency response design considerations—transfer loci, attenuation vs. log-frequency plots, and phase-angle vs. log-frequency plots—and explains the later method which depends upon minimization of rms error with which the mechanism produces a desired result in the presence of electrical noise and other disturbances.

### COMPUTING MECHANISMS AND LINKAGES

**VOL. 27.** Edited by A. SVOBODA. 379 pages, illus. \$4.50

A discussion of computing mechanisms and a detailed study of bar linkages in computers. It includes a full account of novel methods for the design of bar linkages serving as generators of functions of one and two independent variables, and describes the design of bar linkage multipliers.

### TECHNIQUE OF MICROWAVE MEASUREMENT

**VOL. 11.** Edited by C. G. MONTGOMERY, Associate Professor of Physics, Yale University. 937 pages, illus. \$10.00

This book describes in detail the procedures for measuring the properties of microwaves and the circuits in which they are used. A full description of the measurable quantities of microwaves provides sound groundwork for the later chapters which deal with sources of power suitable for measuring purposes and the means for detecting energy at microwave frequencies. Methods for measuring wave length, impedance, frequency, and attenuation are fully described.

### MICROWAVE DUPLEXERS

**VOL. 14.** Edited by L. D. SMULLEN and C. G. Montgomery, Professor of Physics, Yale Univ. 437 pages, illus. \$6.50

An analysis of the problems of using a single antenna for receiving and transmitting pulsed signals. It discusses low-level properties of TR and ATR tubes and the methods for their design. The high-level operation is explained in detail with a description of the properties of the gases used in the tubes. Circuits used for duplexing are fully covered.

### CRYSTAL RECTIFIERS

**VOL. 15.** Edited by H. C. TORREY and C. A. WHITMER, Rutgers Univ. 440 pages, illus. \$6.00

The characteristics and use of the silicon and germanium point-contact rectifiers used as microwave converters and for other circuit applications. Treatment of the theory of semiconductors, of the semiconductor-metal contact, of frequency conversion by rectifiers, and of noise generation by crystals is followed by engineering information on the production and use of practical crystal types. Low-level detectors, high inverse voltage crystals and crystals with negative i-f conductance are discussed in detail.



**SEE THESE BOOKS 10 DAYS FREE**

**McGRAW-HILL BOOK CO., Inc., 330 W. 42d St., NYC 18**

Send me the volumes of the Radiation Laboratory Series indicated by the numbers I have encircled below for 10 days' examination on approval. In 10 days I will remit the price of the books I desire to keep plus a few cents postage, and return unwanted books postpaid. (Postage paid on cash orders—Same return privilege.)

	1	2	3	4	5	7
11	14	15	16	23	25	27
Name	.....					
Address	.....					
City and State	.....					
Company	.....					
Position	.....					

RC-2-48  
(For Canadian price, write McGraw-Hill Co. of Canada Ltd., 12 Richmond St. E., Toronto 1.)

**ALL YEAR ROUND IT'S SENCO**  
for **OUTSTANDING VALUES!**

**WE'VE GOT PLENTY OF TUBES!**

EVERY TUBE IN CARTON, R.M.A. GUARANTEED.

Type	Each	10	Type	Each	10
1A5GT	59c	49c	7Y4	44	35
1U5	36	30	7X7	44	35
1V	45	39	7AF7	44	35
1L4	55	49	12A6	35	25
1T4	69	55	12A8GT	45	37
1S5	69	55	12AT6	50	45
2A5	65	55	12BA6	50	45
2A6	79	69	12BE6	50	45
2X2	79	72	12J5GT	49	39
3A4	69	59	12J7GT	45	39
3Q5GT	55	50	12K7GT	45	39
5U4G	50	40	12K8	65	59
5W4GT	40	36	12Q7GT	45	39
5Y3GT	40	33	12SA7GT	40	32
5Y3G	42	37	12SF7	39	34
5Y4G	40	37	12SQ7GT	40	32
5X4G	40	37	12SK7GT	45	35
6A7	50	45	12SR7	39	34
6A8GT	49	39	12SJ7GT	55	49
6AC5	98	92	24A	49	39
6AC7	65	60	26	39	30
6AK5	74	69	27	42	37
6AG7/6AK7	89	79	41	40	35
6B7G	55	49	42	42	38
6C5GT	40	35	43	54	49
6C6	45	32	45	49	39
6C8G	37	29	47	49	39
6D6	45	37	56	49	39
6F6GT	45	39	57	45	39
6H6GT	45	39	58	45	39
6J5GT	45	39	71A	39	29
6J7GT	42	38	75	50	39
6K6GT	45	39	76	45	39
6K7GT	49	39	77	35	27
6K7G	50	41	78	35	27
6L6G	79	69	80	40	38
6Q7GT	47	39	83V	99	89
6S7	59	48	84/6Z4	45	36
6U7G	35	25	85	49	45
6V6GT	45	39	25L6GT	49	39
6X5GT	49	39	25Z5	49	45
6SA7GT	44	37	25Z6GT	45	39
6SJ7GT	44	37	35W4	43	40
6SK7GT	49	39	35Z3	44	35
6SL7GT	49	47	35Z5GT	43	39
6SN7GT	49	47	35L6GT	45	39
6SQ7GT	44	37	50L6GT	50	45
6SG7	44	39	117Z3	55	45
7C6	44	35	117Z6GT	89	76
7F7	49	44	50B5	42	32
			32L7GT	59	49

1625 TRANSMITTING Beam Power, Amplifier. Same as 807 except 12.6 volt filament medium 7 pin base **14c ea.**

955 ACORN TUBE Detector Amplifier Oscillator Tube—each **19c**

OD3/V10 Voltage Regulator Tube **49c ea.**

829 Push Pull twin-unit. Beam power amplifier tube. **\$1.49 ea.**

**VOLUME CONTROLS**

250,000 ohms tapped with switch 3" shaft	<b>44c ea.</b>
500,000 ohms tapped with switch 3" shaft	
1 meg ohms tapped with switch 3" shaft	
2 meg ohms tapped with switch 3" shaft	
500,000 ohms with switch, 2 1/4" shaft	

**OUTPUT TRANSFORMERS**

50L6	45c ea.
3Q5	45c ea.
8V6	50c ea.

**SPEAKERS**

4" P.M. Speaker	\$1.19
5" P.M. Speaker	1.15
6" P.M. Speaker	1.55
8" P.M. Speaker	2.75
12" P.M. Speaker	
Alnico 5 Magnet	5.49
4 1/2 inch P.M. Speaker	1.89

Standard Brand **FREE** I NEEDLE CUP with motor and PICKUP



60 cycles, 115 volts, with Turntable. Complete **\$4.35**

25% deposit on all orders, balance C.O.D., F.O.B. New York

**SENCO RADIO, Inc.**

96A WARREN ST., N. Y. 7, N. Y.  
TEL. BEEKMAN 3-6498

**TRY THIS ONE**

**SAVING A POWER SUPPLY**

Sometimes, when there is high leakage between the high-voltage and filament windings of a transformer, it is cheaper and easier to install a small filament transformer than to replace the entire unit.

Mount a filament transformer with a rating suitable for the current drawn by the filaments on the chassis or elsewhere in the cabinet, disconnect the filaments from the set's power transformer, and connect the primary to the line on the set side of the ON-OFF switch.

Leakage in a transformer usually being from the high-voltage winding or the rectifier filament winding to the filament circuit, this method will be effective in most cases. The old filament winding remains as additional insulation between the secondary and the rectifier filament winding.

Where the leakage is between primary and secondary (as checked with a high-range ohmmeter) the entire power transformer must be replaced.

T. H. NIO  
Bandoeng, Java

**HANDY TUBE PULLER**

Very often a serviceman has to remove a loctal or GT-type tube from a set and is unable to do so because the set is too compact or the tube too hot to handle. I have constructed a simple tube puller that solves this problem nicely.

A 16-inch length of No. 18 piano wire is bent to the shape shown in the illustration. Wrap the wire around a loctal or GT-type tube to determine the size of the loops.

To use, push the loops down to the top of the tube base. An upward pull tightens the loops on the tube so it can be removed easily. There is little danger of tube breakage since pressure is equal on all sides. Remove the tube from the puller by grasping the spirals, A, with one hand and twisting the tube with the other. It comes out easily.

RALPH BLOOM,  
Brooklyn, N. Y.

**DUTCH TRACER PROBE**

A 1N34 is used in this efficient signal tracer as a probe-detector. The crystal diode, a 500,000-ohm resistor, a 10- $\mu$ f mica condenser, and a .05- $\mu$ f condenser are mounted in the shell of a discarded metal tube and connected to an audio

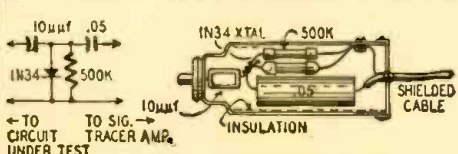

amplifier through a shielded cable.

Its sensitivity is high as compared with a vacuum-tube diode. It can be used as a detector when using a 'scope and frequency-modulated test oscillator for viewing band-pass curves. It is particularly useful when servicing sets with high intermediate frequencies.

JAC. WIGMAN, JR.,  
Radio-Peeters,  
Amsterdam, Holland

**TEST LEAD SWITCHING**

For those fortunate with more than one test instrument, here is a kink to keep unused test leads out of the way and avoid changing them from one instrument to another as the need requires. Mount the instruments close together on a shelf or panel. Mount 3

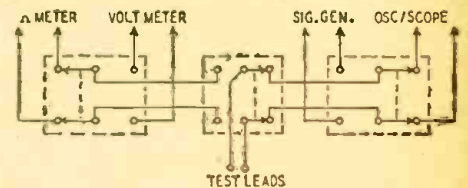

double-pole, double-throw switches on a 3 x 6-inch panel near the instruments. Connect short leads to the instruments and wire them to the switches as shown. The only disadvantage is that no two instruments can be used at the same time.

NICK CARTER,  
Neptune, N. J.

**SUBSTITUTE V.T.V.M.**

A high-resistance voltmeter having a sensitivity of 20,000 ohms per volt or more can be used with negligible detuning for emergency measurements on r.f.-carrying circuits. Connect a r.f. choke having low distributed capacitance to the end of the probe to be connected to the r.f. circuit. If the proper inductance is chosen for the frequency in use, little detuning will be noticed. This is an excellent means of checking a.v.c. voltages at the grids of r.f. tubes in receiver circuits.

This system will not work on the a.c. ranges of the tester, but can be used for measuring d.c. voltages present in r.f. circuits.

G. N. CARTER,  
Nanaimo, British Columbia.

**RECORDING-LEVEL METER**

My recording-level meter burned out and a replacement was unavailable. I noticed that the output transformer of the amplifier had a tapped secondary. By experiment, I found that a 50-ma a.c. meter connected across the 30-ohm tap worked well. I connected a 0.25- $\mu$ f condenser across the terminals to provide damping. An average reading of 20 ma is a good recording level for my cutter.

This can be used also as a cheap recording meter for amateur purposes.

PAUL F. DAVSON, Jr.  
Orchard Park, N. Y.

# You can be a BROADCAST TECHNICIAN or ENGINEER...

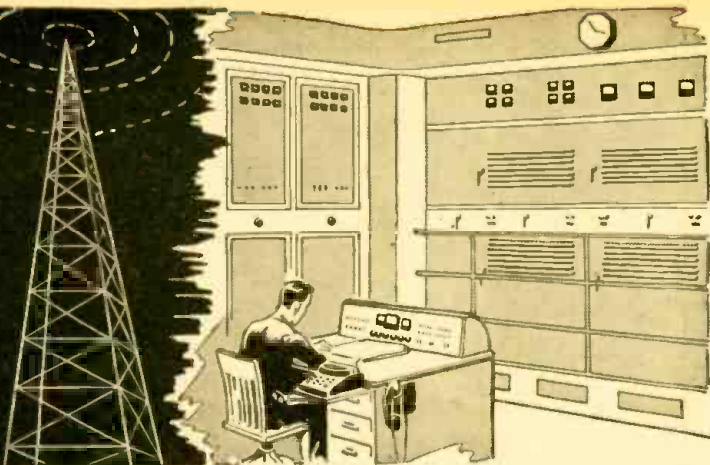

## ADD TECHNICAL TRAINING TO YOUR PRACTICAL EXPERIENCE

### Use CIRE Training and Coaching Service—and Get Your "Ticket" in a Few Short Weeks!

Employment opportunities are plentiful—Now is the time to get in on the ground floor—Permanent employment—steady, good pay—Advancement to those who are qualified—These are only a few of the attractive features of this interesting, pleasant employment!

Get your license without delay—Let Cleveland Institute prepare you to pass FCC license examinations, and hold the jobs which a license entitles you to, with CIRE streamlined, post-war methods of coaching and training.

### Your FCC Ticket Is Recognized in ALL Radio Fields as Proof of Your Technical Ability.

More than ever before an FCC Commercial Operator License is a sure passport to many of the better paying jobs in this New World of Electronics.

Employers frequently give preference to the license holder, even though a license is not required for the job. Hold an FCC "ticket" and the job is yours!

#### HUNDREDS OF SATISFIED, SUCCESSFUL STUDENTS

"I have taken the first class phone license examination and received my first class ticket last Saturday May 31. In closing I must say yours is an excellent radio course, and I really appreciate your help and the fine service you have rendered me."

Student #2876N12

"I passed the FCC examination in radiotelephone 2nd class, at Detroit on June 3rd, and I want to thank you for your ready assistance as my instructor on Section I of Nilson's Master Course."

Student #2779N12

"I have had my 1st class radiotelephone license since March of this year, and plan to continue with your course since I find it a great help in studying transmitters."

Student #2779N12

"After sending in Lesson E-9 I took the commercial operator's license examination for 2nd class radiotelephone, and passed O.K. I received the license last week."

Student #2772N1

**FREE BOOKLET**—Tells you the Government requirements for all classes of FCC COMMERCIAL licenses. (Does not cover Amateur License examinations). Use coupon below for Booklet B.

### OTHER CLEVELAND INSTITUTE HOME STUDY COURSES OFFER COMPLETE TECHNICAL RADIO TRAINING FROM LOW-LEVEL TO COLLEGE-LEVEL, FOR THE RADIOMAN WITH PRACTICAL EXPERIENCE!

#### COURSE A—MASTER COURSE IN RADIO COMMUNICATION

A complete course covering the technical fundamentals of radio-electronics, for the radioman who wants a general review. Includes preparation for Broadcast station employment.

#### COURSE B—ADVANCED COURSE IN RADIO COMMUNICATION ENGINEERING

A genuine college-level radio engineering course, completely mathematical in treatment. For the advanced radioman with considerable practical experience and training.

#### COURSE C—SPECIALIZED TELEVISION ENGINEERING

An advanced college-level course for the radioman who has had formal training equivalent to A and B. Without Preliminaries, every lesson is devoted to television subjects.

#### COURSE D—ADVANCED RADIO TELEPHONY FOR THE BROADCAST ENGINEER

An advanced, specialized course covering broadcast station engineering and operation. Without preliminary preparatory fundamentals, this course enters immediately into the heart of the subject matter. Covers the engineering knowledge and the technical duties required of the studio control operator, the master control operator, and the transmitter operator.

**FREE CATALOG**—Describes all Cleveland Institute home study courses—tells of CIRE unique, post-war methods of training. Use coupon below for Catalog A.

How To Pass  
FCC  
LICENSE  
EXAMINATIONS

CLEVELAND INSTITUTE  
OF  
RADIO ELECTRONICS  
Terminal Tower - Cleveland, Ohio

Don't Delay—  
Write Today!

Approved for Training under "G-1 Bill of Rights"

## HOW TO PASS Commercial Radio Operators' FCC LICENSE EXAMINATIONS...

### CLEVELAND INSTITUTE OF RADIO ELECTRONICS

Contractors to the Canadian Broadcasting Corporation

RC-2 TERMINAL TOWER

CLEVELAND 13, OHIO

CLEVELAND INSTITUTE OF RADIO ELECTRONICS  
RC-2 TERMINAL TOWER, CLEVELAND 13, OHIO

Veterans check for enrollment information under G-1 Bill. NO OBLIGATION—NO SALESMEN.

Gentlemen:  Please send me your Booklet B, "HOW TO PASS THE FCC COMMERCIAL LICENSE EXAMINATIONS," and information about your home study course for preparation for FCC License Examination. (Does not cover Amateur license examinations.)

Please send me your Catalog A, describing all of your home study radio-electronics courses. I desire training in course  A  B  C  D

NAME .....  
ADDRESS .....  
CITY ..... ZONE ..... STATE .....

# RADIOMEN'S HEADQUARTERS — WORLD WIDE MAIL ORDER SERVICE!!!

**RT-1579** consists of a three stage (cascode 6BJ7's and 6F6 output stage) high gain, high fidelity amplifier with 60 cycle, 110V power supply on the same 13½x14½ chassis, which is protected by a substantial steel cover over tubes and parts. Made by Western Electric with typical quality components such as a husky power transformer and oil condensers, this unit is obviously intended to give years of trouble-free service with no more need for repairs than a telephone. Disconnecting one wire each, from the special input and output filters, will result in as high a fidelity amplifier as can be obtained. Your cost with tubes, diagram and parts list included—\$14.95. We also offer the **RT-1579** with a Raytheon Magnetic Voltage Regulator already installed beneath the cover. Imagine an amplifier complete with tubes, built to Western Electric quality standards, and immune to line voltage variations besides, making it perfectly suited for the most difficult industrial, circus, carnival, or commercial installations, offered for a total price of only \$19.95, our price for both units.

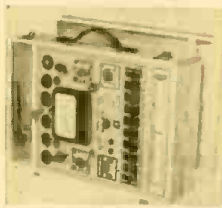

## 1948 MODEL MUTUAL CONDUCTANCE TUBE TESTER ..... \$49.95

No possibility of good tubes reading "Bad" or bad tubes reading "Good" as on dynamic conductance testers or other ordinary emission testers. Attractive panel and ease equal to any on the market in appearance. . . . Large 4½" meter . . . Calibrated micromho scale as well as a Bad-Good scale. . . . Front panel fuse . . . Individual sockets for all tube base types—voltages from .75 volts to 117 volts and complete switching flexibility allow all present and future tubes to be tested regardless of location of elements on tube base. . . . Indicates gas content and detects shorts or opens on each individual section of all local, octal and miniature tubes including cold cathode magic eye and voltage regulator tubes as well as all ballast resistors. Name of the nationally known manufacturer withheld because of special price offer. . . . \$49.95  
**Model "C"**—Sloping front counter case. . . . \$49.95  
**Model "P"**—Handsome hand-rubbed portable case. . . . \$49.95  
 Built-in roll chart with either of above \$5.00 extra.

**\$9.95**

## TAKES ALL THREE BIG BARGAINS

- 1. AUDIO AMPLIFIER** Undreamed of value. Uses 6V6's, has 4 microphone inputs brought to jacks at rear panel. Various output impedances available at rear panel connections. Steel case with chrome handles. 9" long x 9" high x 6" deep. Tubes included. New in original carton. Shipping weight 15 lbs. **SUPER SPECIAL—\$4.95** while supply lasts.
  - 2. RADIO HEADSETS** Latest supersensitive type with rubber earpieces. Every pair guaranteed perfect. \$5.99 per pair OR 3 PAIRS FOR \$1.00.
  - 3. HOME WORKSHOP AT BARGAIN PRICE** Accurate and precise 2 speed guaranteed hobby lathe, the essential machine for the home workshop. Sturdy enough for light production work or factory standby service. Supplied with 58" of belt for connecting to any available electric motor or power take-off, such as on a jeep or tractor. Also included in this unbelievable offer are such accessories as a ½" drill chuck with specially hardened tool steel jaws, a 4" electric furnace high speed grinding wheel, a cotton buffing wheel with a large supply of buffing compound, and a 4" steel wire scratch brush. Your cost \$6.00. Sole export agent. Distributor inquiries invited.
- NO C. O. D.'s—ORDER NOW—DON'T DELAY**

**SCR-284 TRANSMITTER-RECEIVER** — This medium power transmitter and the accompanying 7-tube very sensitive receiver are naturals for 80 or 40 meter operation (phone or CW), on either fixed stations or mobile applications. These units are brand new and come complete with 17 tubes, key microphone, 200 KC calibrating crystal and instructions and diagrams for use with up to 100 watts input to the final stage on 40 or 80 meters for either phone or CW, using vehicle or 110 Volt power supply. Your cost ..... \$39.95

**5" "SO" RADAR P.P.I. SCOPE**, complete with 9 tubes including 807 tube in final power stage that provides deflecting current for magnetic yokes. Selsyn motor and self-contained 110 V. power supply designed to run on the AC supply on LST and PT boats. Various ranges from 2 to 80 miles. The most satisfactory scope available for navigational radar or panoramic television applications. —\$39.95. **"80" Radar ECHO BOXES**, The perfect calibrated cavity wavemeter—\$10.00. **LORAN INDICATOR OSCILLOSCOPES**, including 26 tubes with 5" scope tube. Govt. instruction manual supplied with each of these—\$39.95.



**MICROPHONES**—All nationally known brands. Astatic crystal—\$2.95; Bullet Dynamic—\$7.45; Mike Jr.—60c; Handy Mike—90c; Lapel Mike—93c; **SHURE T-17 MIKES**, with push to talk switch—99c.  
**20 ASS'D COIL FORMS**, including 11 ceramic, 3 polystyrene, and 6 fiber, all useful sizes—50c.  
**VARIABLE CONDENSERS**: 350 MMFD, 5 gang—\$1.95; 4 gang—\$1.49; 3 gang—83c; 2 gang—79c; 7.5 to 20 MMFD, 1750V spacing, extra long shaft Hammarlund—69c; miniature variables, 25 MMFD—39c; 50 MMFD—49c; 75 MMFD—59c; 100 MMFD—69c; 140 MMFD—79c.

**FLUORESCENT LIGHT BALLASTS**. Single 30 or 40 watt, \$1.68; Dual 40 watt High Power Factor—\$3.75.  
**HEADPHONES**—Highest quality Signal Corps headsets with 12" cord and plug \$1.25. 5' rubber covered patch-cords with phone plug and socket—45c.

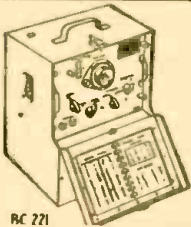

**BC-221 FREQUENCY METERS** with calibrating Crystal and calibration charts. A precision frequency standard that is useful for innumerable applications for laboratory technician, service man, amateur, and experimenter at the give away price of only \$36.95.

**RT1463 7 tube amplifiers** containing 3-7F7, 1-7Y4, 3-7N7, 4 potentiometers, numerous resistors, filter and bypass condensers, filter chokes, power and audio transformers, and six sensitive plate relays. A military development that provided amazing stepless control proportional to correction required for alterations, rudder and elevator, in the original application. A control amplifier of the ordinary type would deflect the rudder either be that the correction was insufficient and the plane continued off course, or the correction would be too great, starting a series of tackings and the plane continued off course, or the correction would be reaching the objective. This phenomenal unit, with its 3 amplifiers and six 5000 ohm relays in bridge circuits, will accurately control any 3 operations, related or unrelated, in minutely adjustable uniquely quantitative variations in either forward or reverse directions. 9"x7"x8" black crackle aluminum case. Brand new in original carton. \$12.95, or used \$9.95.

## AT LAST YOU CAN AFFORD A LABORATORY STANDARD MICRO VOLTER

The famous Measurements Corp. Model 78B, 5 Tube Laboratory Standard Signal Generator (that sold new, FOB Boonton, N. J., for \$310.00 net), is available in perfect condition for 25 to 60 cycle, 115 V AC operation. Until now this is the sort of top-flight lab equipment that discriminating buyers have only vainly hoped would be released at a bargain price. Worth every cent the manufacturer asks, but available FOB Buffalo while our limited supply lasts for only \$79.95. Such companies as Admiral Corp. and John Meck, Inc., have ordered from us and repeated many times on these 78 generators for use in their labs and production line testing. **"REMEMBER THAT A STANDARD IS ONLY AS RELIABLE AS ITS MAKER."**



Model 78-B Standard Signal Generator. Two Frequency Bands between 15 and 250 megacycles.

## GENERAL ELECTRIC RT-1248 15-TUBE TRANSMITTER-RECEIVER

**TERRIFIC POWER**—(20 watts) on any two instantly selected, easily pre-adjusted frequencies from 435 to 500 Mc. Transmitter uses 5 tubes including a Western Electric 318 A as final. Receiver uses 10 tubes including 955's, as first detector and oscillator, and 3-7H7's as IF's, with 4 slug-tuned 40 Mc. IF transformers, plus 7H7, 7E8's and 7F7's. In addition unit contains 8 relays designed to operate any sort of external equipment when actuated by a received signal from elsewhere. Originally designed for 12 volt operation, power supply is not included, as it is a cinch for any amateur to connect this unit for 110V AC, using any supply capable of 400V DC at 135 MA. The ideal unit for use in mobile or stationary service for running the RT-1248 transmitter on either code or voice in AM or FM transmission or reception, for Citizens' Radio Telephone Band where no license is necessary. Instructions and diagrams supplied as a mobile public address system, as on 80 to 110 Mc. FM broadcast receiver, as a Facsimile transmitter or receiver, as an amateur television transmitter or receiver, for remote control relay hookups, or mobile use, the dynamotor which will work on either 12 or 24V DC and supply all power for the set is only \$15.00 additional.

## CLOSING OUT

THE FOLLOWING DESIRABLE ITEMS AT SACRIFICE PRICES TO MAKE ROOM IN OUR WAREHOUSE FOR INCOMING STOCK.

**947A ONE KILWATT HIGH FREQUENCY TRANSMITTER**. This relay-controlled transmitter includes a 115V, 60 cycle power supply. Protected by 8 magnetic circuit breakers, that alone is worth more than the price we are asking for the whole rig, even on today's surplus market. On the front panel are six 3¼" GE or Westony meters, including 250 MA 50 MA, 1000 MA, 150 V AC and 1500 V DC at 1000 ohms per volt for screens and plate. The rack-type 21" x 15" x 36" unit contains six amplifier and rectifier tubes aggregating over \$60.00 at WAA current wholesale prices. Western Electric's price to the government was \$150.00. Shipping weight 500 lbs. Your cost at close-out price as is. Formerly \$69.95, now only ..... \$39.95

**BC-412 5" RADAR OSCILLOSCOPE**. Easily converted to a first class lab scope or to an excellent home television receiver using the instructions in the August 1947 RADIO NEWS. Furnished with a brand new 5HP4 tube for the television application or a brand new 5BP1 for the scope application. Specify your choice. Sold at close-out price as is. Formerly \$59.95, now \$29.95

**5 INCH RECEIVER INDICATOR SCOPE**. This unit, originally sold by Western Electric for \$250.00 includes a 13 tube receiver with 7 IF stages; 2 tube multivibrator sweep generator; 2 tube sweep amplifier; video amplifier; pedal impulse and sweep generator, and 115 volt, 60 cycle supply with 2 x 2 for high voltage. Equipped with more than 15 tubes of the 43 originally used and including a brand new scope tube in original carton. Makes a wonderful laboratory instrument and is better adapted for television than any other war surplus item. Reduced close-out price as is. Formerly \$69.95, now \$39.95

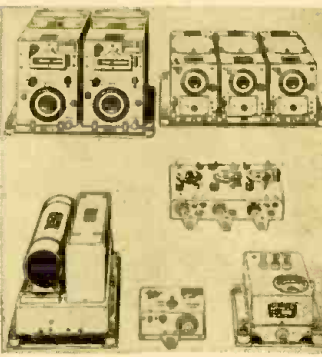
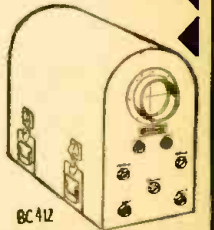

## SCR-274N COMMAND SET

The greatest radio equipment value in history

A mountain of valuable equipment that includes 3 receivers covering 190 to 550 KC; 9 to 6 MC; and 6 to 9.1 MC. These receivers use plug-in coils, and consequently can be changed to any frequencies desired without conversion. Also included are two Tuning Control Boxes; 1 Antenna Coupling Box; four 28 V. Dynamotors (easily converted to 110 V. operation); two 40-Watt Transmitters including crystals, and Pre-amplifier and Modulator. 29 tubes supplied in all. Only a limited quantity available, so get your order in fast. Removed from unused aircraft and in guaranteed electrical condition. A super value at \$29.95, including crank type tuning knobs for receivers. Without these knobs the receivers can't be tuned, and are only useful for parts. Don't buy without knobs!

**BUFFALO RADIO SUPPLY, 219-221 Genesee St., Dept. 2 C. BUFFALO 3, N. Y.**

# ADIOMEN'S HEADQUARTERS - World Wide Mail Order Service!!!

## AUTO RADIO DEALERS! ATTENTION!

A famous nationally advertised brand of auto radio which will fit any car and every pocketbook. Six tube superhet with three gang condenser and 6 1/2" speaker. Dealer price \$32.20 for sample, or \$29.97 each, in lots of two or more.

### INTRODUCTORY OFFERING OF OUR OWN BRAND CAR RADIO ANTENNAS

All of our car radio antennas are made of triple plated Admiralty Brass Tubing, complete with low loss shielded antenna leads and have high quality fittings.

- SIDE COWL—BR-1**, 3 sections extend to 66". Your price—single units—\$1.50; in lots of 12—\$1.35 ea.
- SKYSCRAPER—BR-2** has 4 heavy duty sections that extend to 98". Your price—single units—\$2.45; in lots of 12—\$2.25 ea.
- TILT ANGLE—BR-3**, may be adjusted to all body contours. 3 sections extend to 66". Single unit price—\$1.50; 12 lot price—\$1.25 ea.
- VERSATILE—BR-4**, single hole fender or top cowl mounting may be adjusted to conform with all body contours. 4 sections extend to 56". Single unit price—\$2.90; 12 lot price—\$2.75 ea.
- THE MONARCH—BR-5**, single hole top cowl mounting, 3 sections extend to 56". Single unit price—\$1.90; 12 lot price—\$1.75 ea.

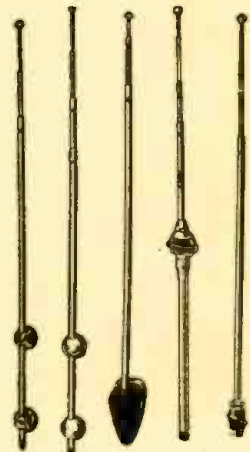

BR1 BR2 BR3 BR4 BR5

**BENDIX SCR 522**—Very high Frequency Voice Transmitter-Receiver—100 to 156 MC. This job was good enough for the Joint Command to make it standard equipment in everything that flew, even though each set cost the Gov't \$2500.00. Crystal Controlled and Amplitude Modulated—HIGH TRANSMITTER OUTPUT and 3 Microvolt Receiver Sensitivity gave good communication up to 180 miles of high altitudes. Receiver has ten tubes and transmitter has seven tubes, including two 832's. Furnished complete with 17 tubes, remote control unit, 4 crystals, and the special wide band VHF antenna that was designed for this set. These sets have been removed from unused aircraft and are guaranteed to be in perfect condition. We include free parts and diagrams for the conversion to "continuously variable frequency coverage" in the receiver.

The SCR 522 complete with 24 volt dynamotor sells for only \$37.95. The SCR 522 is also available with a brand new 12 volt dynamotor for only \$42.95.

### DUE TO POPULAR DEMAND WE REPEAT THESE TERRIFIC BARGAINS

- Three assorted new MICROPHONES, including push-to-talk type ..... \$1.49
- Ten assorted R. F. Chokes including high frequency types ..... \$ .35
- Five assorted AUDIO or FILTER CHOKES ..... \$ .99
- One Hundred assorted RESISTORS ..... \$1.95
- Ten assorted JAN CABLE CONNECTORS, including many popular types ..... \$ .99
- Six assorted OIL FILLED CAN TYPE CONDENSERS, all with mounting brackets ..... \$1.49
- Ten assorted METAL & BAKELITE KNOBS—(no wooden knobs) ..... \$ .39
- Six assorted VARIABLE CONDENSERS, including butterfly types ..... \$1.49
- Six assorted POWER and AUDIO TRANSFORMERS, all new ..... \$1.98
- Six assorted isolantite and bakelite R. F. COILS, shielded and unshielded ..... \$ .99

The above ten assortments, totaling over \$12.00 at the unbelievable bargain prices listed, can be purchased together as one lot at a super-special total price of \$9.95, a value so incredible that you will rub your eyes as you read this, our new year get-acquainted offer. All merchandise guaranteed to be as advertised.

Minimum order \$3.00—All prices subject to change—25% deposit with COD orders

### GENERAL ELECTRIC 150 WATT TRANSMITTER

Cost the Government \$1800.00  
Cost to you \$44.50!!!!

This is the famous transmitter used in U.S. Army bombers and ground stations, during the war. Its design and construction have been proved in service, under all kinds of conditions, all over the world. The entire frequency range is covered by means of plug-in tuning units which are included. Each tuning unit has its own oscillator and power amplifier coils and condensers, and antenna tuning circuits—all designed to operate at top efficiency within its particular frequency range. Transmitter and accessories are finished in black crackle, and the milliammeter, voltmeter, and RF ammeter are mounted in the front panel. Here are the specifications: FREQUENCY RANGE: 200 to 500 KC and 1500 to 12,500 KC. (Will operate on 10 and 20 meter band with slight modification). OSCILLATOR: Self-excited, thermo compensated, and hand calibrated. POWER AMPLIFIER: Neutralized class "C" stage, using 211 tube, and equipped with antenna coupling circuit which matches practically any length antenna. MODULATOR: Class "B"—uses two 211 tubes. POWER SUPPLY: Supplied complete with dynamotor which furnishes 300V at 350 MA. Complete instructions are furnished to operate set from 110V AC. SIZE: 21 1/2 x 23 x 9 1/2 inches. Total shipping weight 200 lbs., complete with all tubes, dynamotor power supply, five tuning units, antenna tuning unit and the essential plugs. These units have been removed from unused aircraft but are guaranteed to be in perfect condition.

### 14-TUBE UHF SUPERHET RECEIVER—\$39.95

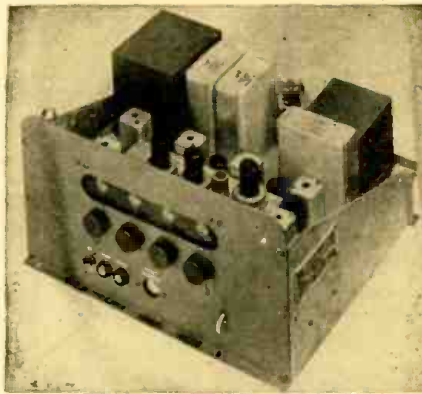

This beautifully constructed receiver was designed especially for Signal Corps communication service, and is one of the finest and most sensitive sets ever manufactured. Operating from 110V 60 cycles, this set has two tuned RF stages, tuned converter and oscillator, five I.F. stages, using iron-core IF's, a diode detector, tuning eye, and a two stage amplifier that will drive a speaker or phones. The frequency range is 158-210 Mcs. It is a simple matter to operate on other bands by making a slight alteration in the tuning coils. A complete set of tubes is included with each receiver, along with a circuit diagram and parts list. The high-voltage power supply delivers 150 milliamperes, and is well filtered by a heavy-duty choke and three 7 Mfd. oil-filled condensers. This buy of a lifetime cost the government about \$700. Amateurs and experimenters will never again be able to purchase fine equipment at such a tremendous saving!

### PE-109 32-Volt DIRECT CURRENT POWER PLANT

This power plant consists of a gasoline engine that is direct coupled to a 2000 watt 32 volt DC generator. This unit is ideal for use in locations that are not serviced by commercial power or to run many of the surplus items that require 24-32V DC for operation. The price of this power plant is only \$58.95. We can also supply a converter that will supply 110v AC from the above unit or from any 16-32V DC source for \$29.95.

### ARMY BC-312 COMMUNICATIONS RECEIVER

This receiver covers the frequency range of 1.5 MC to 18 MC in six direct reading bands. The dial, that is driven with split gears to prevent backlash, has 4500 logging divisions per band with approximately 40 divisions on the 20 and 40 meter ham bands and 1000 divisions on 80 meters. Two stages of RF before a converter in this set give it a very high signal to noise ratio and maximum sensitivity. Outstanding features of this receiver are: BFO with bleed controls send-receive relay, jacks on the front panel for headphones and speaker output, and mike and key inputs. All tubes are standard 6 volt types. This receiver is designed to withstand rough usage in the field and for operation from vehicles while in motion, so it is ruggedly constructed and contains a dynamotor power supply—Your cost \$49.95. Conversion kit to 0 V AC is available for ..... \$6.50

**BUFFALO RADIO SUPPLY, 219-221 Genesee St., Dept. 2 C. BUFFALO 3, N. Y.**

Cable Address: BUFRAD

# TRANSVISION

## 7" TELEVISION KIT

with COMPLETE FM RADIO



**COVERS  
ENTIRE  
FM BAND  
(87.5 to  
108.5 MC)**

### TRANSVISION 7" De Luxe Television Kit with FM Radio Receiver

Easy to assemble; no technical knowledge required. 18 tubes and picture tube. Folded Dipole Antenna and 60 ft low-loss lead in cable. . . . . LIST \$199.00  
7" Standard Television Kit. . . . . LIST \$169.00  
Table Model Cabinets for above . . . . . LIST \$32.50

### 10" CONVERSION KIT

with 10" Electrostatic Tube and Directions. Converts any 7" Television Kit to 10" size. . . . . LIST \$69.00  
Also 10" STANDARD TELEVISION KIT. LIST \$239.00  
Table model cabinet . . . . . LIST \$35.00

### TRANSVISION PICTURE BLOW-UP LENS

Brilliantly enlarges any 7" television picture to equivalent picture of 10" television set. Has adapter arrangement for Transvision Panels and cabinets. Optically ground and polished to high accuracy. Plastic, gives 60% greater light transmission than equivalent glass lens. LIST \$19.95

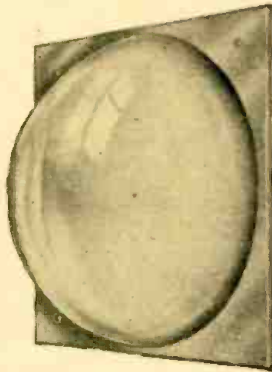

### TRANSVISION 8-TUBE FM RADIO RECEIVER

Covers entire FM Band (87.5 to 108.5 mc)

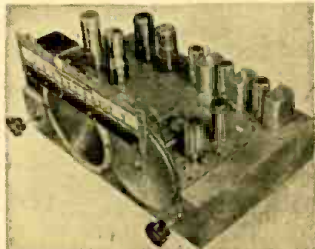

No technical knowledge required for assembly. Makes an FM Radio Receiver worth 2 to 3 times cost of kit. Model FM-1 8-tube FM Radio Receiver Kit with 10" Speaker and Tubes. . . . . LIST \$64.95

### FM CONVERSION KIT

enables you to incorporate a complete FM Radio into your present television receiver. . . . . LIST \$29.95

### HIGH-FIDELITY FM TUNERS

Model FMF-2 . . . . . 2-tube Tuner Front End (less tubes) . . . . . LIST \$21.65  
Model FMF-3 . . . . . 3-tube Tuner Front End (less tubes) . . . . . LIST \$30.75  
Model FM-107R. . . . . 3-Tube IF Amplifier Kit (less tubes) . . . . . LIST \$21.65  
Model FM-107 . . . . . 6-Tube IF Amplifier Kit (less tubes) . . . . . LIST \$41.20

All prices fair traded. All prices 5% higher west of the Mississippi River.

See your local distributor, or for further information write to:

**TRANSVISION INC.** Dept. R. C.  
385 North Ave., New Rochelle, N. Y.

## MAGNETIC RECORDING

(Continued from page 31)

whole hour's recording in order to hear a selection at the end of the wire roll.

- It is comparatively simple to splice magnetic tape so that the actual splice cannot be heard. On the other hand, a knotted splice on wire invariably can be heard because the build-up in the knot pushes the wire away from the recording or playback head.

### Advanced recording theory—

Many technicians have experienced difficulty in grasping the full significance of all of the elements involved in the actual magnetization of the tape itself. The explanation that the tape is magnetized with a magnetic pattern similar to the sound wave picked up by the microphone is oversimplified. The difficulty lies in the analysis of the magnetic recorded pattern, which in turn is usually tied to the technician's concept of either a bar or horseshoe magnet.

Those RADIO-CRAFT readers who have a casual knowledge of the nature of the mosaic of an iconoscope and who have a little knowledge of the variable-density method of motion picture sound recording, will find it extremely simple to grasp a down-to-earth explanation of the elements involved in recording on magnetic tape.

Magnetic tape should be viewed as a specially treated paper base coated with very fine particles of special magnetic material held in a suitable binder. Each magnetic particle becomes a magnetic island similar to the silver globule in the iconoscope. If each magnetic island is viewed as an extremely small sphere, we can begin to evaluate the importance of particle size, binder, dispersion, and smoothness upon the over-all performance of the magnetic recording-reproducing process.

Before discussing the effects of these factors, it might be desirable to learn how some early German tape was made. The actual magnetic material used was a magnetic ferric oxide obtained by the reaction of ferrous sulphate, ammonia, and ammonium nitrate which produced a very finely divided black magnetic iron oxide, which was subsequently crystallized out of solution. This black oxide was then further oxidized at 230° C. for 6 hours in a specially constructed agi-

tated dryer utilizing air pressure to produce the red ferric oxide which has the same crystal structure as the magnetite, and therefore possesses magnetic properties. Each of the minute crystals was about 1 micron (1/40,000 inch) in size. This material was then suitably fixed with a special plastic binder and deposited on the tape.

As previously indicated (see November, 1947, issue of RADIO-CRAFT), when a 5,000-cycle signal is recorded on tape moving at a speed of 4 inches per second, it will have a total wave length of 8/10,000 inch. The distance between the maximum and minimum magnetic recorded phase will be 1/2 wave length or 4/10,000 inch. For ideal recording resolution, the magnetic particle size should be at least 10 times smaller, which brings us back to a particle size of approximately 1/40,000 inch (or 1 micron). Smaller particle sizes will of course do no harm.

In fact, the smaller the particle, the easier it is to obtain proper dispersion during application. Obviously, the more uniform the particles are in size, the smoother will be the coating. A smooth coating assures negligible variations in distance between the magnetized particles and the pickup head. Significant variations in this distance will increase the amplitude variations at high frequencies.

The effect of particle size upon playback quality is analogous to the particle size of metallic silver in variable density sound on film recording. (Incidentally, another important analogy between magnetic recording and variable density sound on film recording is the effect of slit width—and magnetic gap length—upon the resolution of the playback system.)

The nature of the binder is obviously important. It is desirable to utilize a binder which will keep the magnetic particles permanently fastened to the paper base. Inasmuch as magnetic tape must be in actual contact with both the recording head during recording and the playback head during playback, actual friction between the elements could scrape magnetic material off the tape if an improper binder is used. The binding material, itself, has been highly perfected that tape may now

(Continued on page 76)

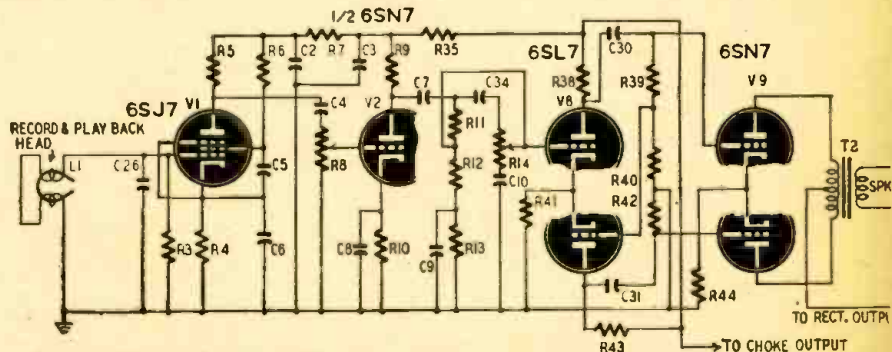

Fig. 2—The playback amplifier is a low-power unit intended for monitoring purposes.



**BIGGEST SAVINGS IN HISTORY!**

# RADIO KITS and PARTS

**PROGRESSIVE**



## BUY THE PROGRESSIVE UNIT WAY!

Our prices for radio kits and parts have always been amazingly low. NOW, mass sales have made possible even further drastic reductions through our revolutionary PROGRESSIVE UNIT plan. The Progressive Radio Kit, for instance—earlier reduced from \$19.75 to \$14.75—can now be purchased at a cost of two kits for \$28.15 and three kits for only \$41.50! Buy the PROGRESSIVE UNIT way and save \$\$\$\$\$\$! See below for our Progressive prices on individual items.

### Progressive AMPLIFIER KIT

This newest Progressive Kit, designed by a former Western Electric engineer, comes to you complete with all parts, tubes and a 12" P.M. speaker, enabling you to build a newly-designed, high-fidelity, humless amplifier. Kit includes beautiful aluminum custom-punched chassis, etched tone and volume control plates. Ideal amplifier for television kit or set, FM tuner, AM tuner, microphone, phonograph, wire and instantaneous recorders. Electrify your musical instruments by connecting them to the Progressive amplifier by means of a contact mike. Can be readily modified to match the GE reluctance pick-up. Separate mike and phono input. Regulated power supply maintains constant voltage supply. DC heater supply, whether amplifier is used on AC or DC, provides humless operation by eliminating cathode heater leakage hum. Contains degenerative feedback for improved frequency response, balanced phase inversion and push-pull beam power output. Every stage thoroughly decoupled to improve low-frequency response and prevent motorboating. Tone and volume controls completely variable. Seven-tube performance. Uses two selenium rectifiers, 2 beam power amplifiers, 1 high-mu pentode mike amplifier, 1 twin-triode phase inverter and 1 voltage regulator tube.

**PROGRESSIVE UNIT PRICES ON AMPLIFIER KIT**  
1 Kit \$25.75    2 Kits \$49.50    3 Kits \$69.00

IDEAL AMPLIFIER FOR YOUR TELEVISION KIT

**BUILD 15 RADIOS \$14.75**  
COMPLETE KIT    Only ...

**ABSOLUTELY NO KNOWLEDGE OF RADIO NECESSARY**  
**YOU NEED NO ADDITIONAL PARTS**

THE PROGRESSIVE RADIO KIT is the ONLY COMPLETE KIT. Contains everything you need. Instruction Book, Metal Chassis, Tubes, Condensers, Resistors and all radio parts. The 36-page book written by expert radio instructors teaches you to build radios in a professional manner. You start with one-tube receivers, then build two-tube receivers, then three-tube receivers. (The three-tube receivers are equal to four-tube receivers because of the addition of a selenium rectifier.) You then construct a powerful public address system which will permit you to address large audiences. Then you make three different transmitters so you can get a real thrill out of being on the air. Before you are done with this kit, you will have built 11 receivers, 1 Public Address System and 3 transmitters.

### Special FREE OFFER

Electrical and Radio Tester sent absolutely FREE with each Progressive Radio Kit. PLUS FREE membership in Progressive Radio Club. Entitles you to free expert advice in consultation service with licensed radio technicians. Write for further information or ORDER your KIT NOW!

**PROGRESSIVE UNIT PRICES ON**

1 Kit	\$14.75
2 Kits	28.15
3 Kits	41.50

**RADIO KIT . . . .**

## RADIO PARTS SCOOP!

No Surplus—All Parts Guaranteed Brand New!

### ELECTROLYTIC CONDENSERS

20-20 mfd. 150 W.V.DC. Regular Price 75c  
Buy 1 for 30c and save 45c  
Buy 4 for \$1.16 and save \$1.84  
Buy 7 for \$1.96 and save \$3.29  
Buy 10 for \$2.65 and save \$4.85  
40-40 mfd. 150 W.V.DC. Reg. Price \$1.05  
Buy 1 for 45c and save 60c. Buy 4 for \$1.70 and save \$2.50. Buy 7 for \$2.80 and save \$4.55. Buy 10 for \$3.80 and save \$6.70. 10-10 mid. 450 W.V.DC. Reg. Price \$1.25. Buy 1 for 65c and save 60c. Buy 2 for \$1.24 and save \$1.26. Buy 3 for \$1.74 and save \$2.01.



### 12" ALNICO SLUG SPEAKER

Regular price \$8.00  
Buy 1 for \$5.60 and save \$2.40  
Buy 2 for \$10.80 and save \$5.20  
Buy 3 for \$15.95 and save \$8.05  
(No more than 3 to a customer)

### ANTENNA AND RF COIL SET

(broadcast Band) Reg. Price \$1.00  
Buy 1 set for \$9c and save 41c  
Buy 2 sets for \$1.10 and save 90c  
Buy 4 sets for \$2.08 and save \$1.92



### PROGRESSIVE RADIO TOOL KIT

A Progressive Electronics Special.  
Contains 55 watt 110/120 volt soldering iron, radioman's combination long nose pliers and cutters, amber handle screw driver, Polystyrene alignment tool.  
Regular price \$4.95  
Buy 1 kit for \$3.25 and save \$1.70  
Buy 2 kits for \$6.10 and save \$3.80  
Buy 3 kits for \$8.70 and save \$6.15  
(No more than 3 kits to a customer)



Radioman's Combination LONG NOSE PLIERS and CUTTERS 6" exceptional quality. Hydrized for extra toughness. Diamond-tested cutters. Regular price . . . \$1.95  
Buy 1 for \$1.45 and save \$.50  
Buy 2 for \$2.70 and save \$1.20  
Buy 3 for \$3.60 and save \$2.25



Famous Make SOLDERING IRON

55 watts 110/120 volts.  
Regular price \$2.50  
Buy 1 for \$1.90 and save 60c  
Buy 2 for \$3.60 and save \$1.40  
Buy 3 for \$5.10 and save \$2.40

### CONDENSER KIT

50 paper tubular condensers. Values from .002 mfd. to .1 mfd.. 400 v.d.c. to 600 v.d.c. Regular Price \$5.00  
Buy 1 kit for \$1.95 and save \$3.05  
Buy 2 kits for \$3.80 and save \$6.20  
Buy 3 kits for \$5.55 and save \$9.45



### VARIABLE CONDENSER

(420-420 mfd.)  
Regular Price \$1.80  
Buy 1 for \$1.45 and save 35c  
Buy 2 for \$2.60 and save \$1.00  
Buy 3 for \$3.60 and save \$1.80



### SELENIUM RECTIFIERS

Regular price \$1.10  
Buy 1 for 79c and save 31c  
Buy 2 for \$1.54 and save 66c  
Buy 3 for \$2.25 and save \$1.05



### PHONES—Single Head Set

1000 Ohms DC. Reg. Price \$1.65  
Buy 1 for \$1.10 and save 55c  
Buy 2 for \$1.90 and save \$1.40  
Buy 3 for \$2.55 and save \$2.40



# PROGRESSIVE ELECTRONICS CO.

DEPT. RC-10

497 UNION AVE., BROOKLYN 11, N. Y.



## BE CONFIDENT WITH A MICROPHONE BY TURNER

Whether it's a general purpose unit for voice and music, or a unit for a specialized application you'll always be confident of accurate pickup and faithful reproduction when your microphone is a Turner. Turner Microphones are proving their superiority in design and manufacture to new users every day.

Illustrated is the Turner Model 33—a high fidelity all purpose microphone that combines high output with smooth response over a wide frequency range. Its matched acoustic design results in crisp, clear speech reproduction . . . music is full and round with tonal qualities faithfully retained. Furnished in a choice of high quality crystal or rugged dynamic circuits. It is recommended for studio recording, remote control broadcast, orchestra pickups, paging, dispatching and call systems, public address and communications work.

### MODEL 33X CRYSTAL

Response: Flat within  $\pm 5$ db from  
30-10,000 cycles.  
Output Level: 52db below 1 volt/  
dyne/sq. cm.

Impedance: High impedance.

Crystal: High quality moisture sealed  
crystal.  
Stand Coupler: Standard  $\frac{1}{8}$ "—27 thread.  
Cable: 20 ft. removable cable set.

### MODEL 33 DYNAMIC

Response: Flat within  $\pm 5$ db from  
40-10,000 cycles.  
Output Level: 52db below 1 volt/  
dyne/sq. cm.

Impedance: 50 ohms/250 ohms/500  
ohms/high impedance.  
Magnetic circuit: Heavy duty dynamic  
cartridge.  
Stand Coupler: Standard  $\frac{1}{8}$ "—27 thread.  
Cable: 20 ft. removable cable set.



## THE TURNER COMPANY

902 17th Street N. E., Cedar Rapids, Iowa

Licensed under U. S. Patents of the American Telephone and Telegraph Company, and Western Electric Company, Incorporated. Crystals licensed under patents of the Brush Development Company.

**TURN TO TURNER FOR THE FINEST IN ELECTRONIC EQUIPMENT**

## TECHNOTES

### ... EMERSON FV433 AND FV426

I have had several of these models in for repair. Complaint was distortion when used on a.c. but O.K. on batteries. The trouble is in the a.c. jack on the set. After some use, the jack contacts do not open. Satisfactory operation is restored by reshaping the contacts.

JAMES MOUDRY,  
Cicero, Ill.

### ... SETHCELL CARLSON 416

Hum in this model can often be traced to the socket of the 12SQ7. The leads from the switch and other components are grounded to a lug riveted to the socket. Very often this lug makes poor contact with the chassis. Solder a wire between the lug and the metal case of the volume control to clear up the trouble.

HAVEN R. WHANGER,  
Steubenville, Ohio

### ... TRANSFORMER REPAIRS

When half of the secondary of an auto radio vibrator transformer opens, the voltage usually drops to a value too low for satisfactory operation. An emergency repair can usually be effected by paralleling the plates of the rectifier tube thus reducing its internal resistance. Connect the open side of the buffer condenser to ground. Additional input filter capacity may be used to add a few volts to the output and increase the filtering.

ARTHUR S. SIMON,  
Miami Beach, Fla.

### ... PHILCO MODEL CT-11

Hum and vibrator noise in these models has been traced to corrosion between the socket rivets and the chassis. A separate ground between the shield of the 75 and ground cures troubles from this source.

HART WEBBER,  
Red Bank, N. J.

### ... TUNABLE HUM

I have had no end of trouble with tubes like the 35Z3, 35Y4 and others when they are used in the field of a loop antenna. They often create an r.f. disturbance similar to tunable hum even when they test perfect. I have known new tubes to have this trouble.

A shield around the offending tube often cures the trouble. Be sure that the shield is grounded or makes contact with the metal shell around the base.

CLIFFORD PENNISTON,  
Argyle, Wisconsin

## SCOOP!

NEW PACKAGE DEAL SAVES YOU MONEY		
List Price—Assorted Brands		Your Cost
11.50	10 35Z3 TUBES	\$ 3.90
15.00	10 50L6 TUBES	4.90
10.50	10 5Y3 TUBES	3.30
ALL TUBES IN INDIVIDUAL CARTONS		
20.00	10 WALLORY 40-20-150 V.	4.90
7.50	50 ASSTD. BYPASS COND.	3.50
5.00	100 ASSTD. RESISTORS	1.85
2.00	100 FT. ASSTD. DIAL CORD	1.00
6.00	10 OSC. COILS 455 K.C.	3.30
15.00	10 CENTRALAB VOL. CONT. 5 MEG. W. SWITCH	4.90
Package Kit of All Above Items. ONLY.....\$28.50		

Write for Free Illustrated Catalog:  
SERVICEMEN:  
BARGAINS GALORE

JOYCE RADIO DISTRIBUTORS  
BOX 2068, HOLLYWOOD 28, CALIF.

# HERSHEL'S HAM HEAVEN...

High quality surplus materials at prices you want to pay!

## BC-620-A RECEIVER AND TRANSMITTER



**ONLY \$9.95**  
F-200

Radio set BC-620-A is a portable low power frequency modulation set capable of dependable communication. Frequency range 21-27 MC. Either of 2 Xtal controlled pre-set frequencies may be chosen by throwing the channel switch. The change from receiving to transmitting is made by pressing a button on the hand-set microphone. The fact that this equipment incorporates the latest FM circuit makes it adaptable to

uses in locations where noise levels are extremely high. Power requirements for receiver are as follows: "A" supply—1.5V at 7 amps. "B" supply—90V at 25 milliamperes. Transmitter 7.5V. "A" at 3 amps and 150V. "B" at 45 milliamperes. This equipment is used depot stock, is in good condition and comes complete with the following tubes: (1)VT 177 or 1LH4, (1)VT 178 or 1LC6, (4)VT 179 or 1LN5, (2)VT 182 or 3B7/1291, (1)VT 183 or 1R4/1294, (4)VT 185 or 3D6/1299.

## BN IFF TRANSMITTER AND RECEIVER



**\$9.95**  
F-227

This set can be used as a TELEVISION RECEIVER. This being made possible by the wide band 30MC IF channel and video amplifier. Now being sold at the lowest price in the country. Diagrams furnished, less tubes and power transformer. Weight 100 lbs.

## BC-733-D RADIO RECEIVER



**\$5.95**  
F-225

A part of aircraft blind landing equipment manufactured by W.E. Operates on any one of its pre-determined Xtal controlled frequencies in the range of 108-120 MC. Contains 10 tubes, three of which are W.E. 717A's, and Xtals. Ideal receiver for conversion to 144MC ham band or mobile telephone bands. For 24 VDC operation. 14 1/2 x 7 x 4 1/2". Complete with tubes.

## BC-223 TRANSMITTER

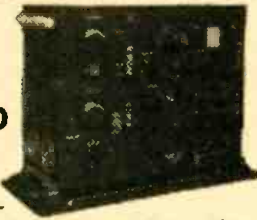

**\$12.50**  
F-301

4 Xtal controlled freq. and master oscillator. Meters for osc., ant., and total current. Uses 46 speech amplifiers. 2-46 modulators, 801 each as oscillator and power amplifier. Practically no conversion necessary: plug in crystal mike and connect power supply and it's ready to operate. Brand new with one tuning unit and circuit. Diagrams. (Less tubes)

## GENERAL ELECTRIC METER

Type D041, 0-1 ma meter scale graduation 0-5 DC Kilo V. and 0-10 ma. BC.

**\$3.95**  
F-232



## 5 GANG VARIABLE CONDENSER

Approx. 50 MMFD per section with individual air tunnel padders. 18 to 1 vernier drive.

**\$1.95**  
F-243



## HIGH SPEED PHOTO FLASH TUBE

**\$8.95**  
F-222

Complete line of GE photo flash tubes in stock.

## McELROY TG 10 KEYER



**\$9.95**  
F-300

Makes excellent code practice machine, using tape or key. Variable words per minute adjustment. Clean, quick keying, using photo-cell.

Operates on 110V 60cy. Slightly used but in excellent condition. Price does not include tubes.

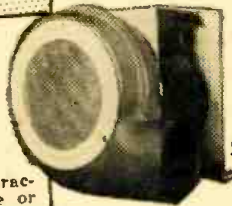

## SQUIRREL CAGE BLOWER

2" outlet, 110 AC. Silent ball bearing motor with mounting bracket.

**\$7.95**  
F-258

## MODULATION TRANSFORMER AND DRIVER TRANSFORMER. BOTH FOR ONLY

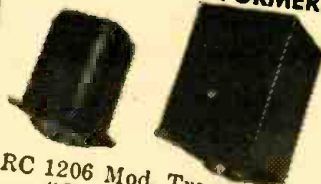

**\$4.95**  
F-302

RC 1206 Mod. Trans. 815 to 815 Class "C" load. 56W audio  
RC 1205 Driver Trans. 6SN7 to 815 Class "B". Companion to RC 1206.

## TUBES

815 — \$1.95

3AP1	- 1.95
3BP1	- 1.95
5BP1	- 2.95
6FP7	- 1.95
7BP7	- 2.95
9LP7	- 3.95
VR150	- .69
955	- .44
9001	- .44
9002	- .44
9004	- .44
9006	- .44
50B5	- .89
35W4	- .69
872A	- 1.95
RK60	- .95
1T4	- .44
3Q4	- .44
354	- .44
1N5	- .69
1H5	- .69
3Q5	- .69
VT127A	- 2.95

- IDEAL FILAMENT TRANSFORMER 110V-60cy. 220V at 50 ma. 6.3V at 1 amp. 6.3V at 2 amps. 5V at 6.5 amps. 6 x 4 1/2 x 5". Shipping wt. 11 lbs. F271 \$1.29
- PYRANOL CAPACITATOR G. E. 1 MFD. 5000 VDC 4 x 4 1/2 x 3 3/4" F 229 \$2.95
- SPRAGUE CONDENSER 1 MFD 7000V. F219 \$1.95
- No. 18 COPPERWELD WIRE 3000 feet F240 \$2.95
- MICA CAPACITATOR .002 MFD 3000 VDC F241 49c

# HERSHEL

SEND FOR FREE BULLETIN!

# RADIO COMPANY

PLEASE ORDER BY CATALOG NO'S.  
20% DEPOSIT REQUIRED ON ALL ORDERS  
Michigan Customers Add 3% Sales Tax

5249 GRAND RIVER

DETROIT 8, MICHIGAN

ORDERS OVER 5 POUNDS TO BE SHIPPED EXPRESS  
ORDERS UNDER 5 POUNDS TO BE SHIPPED PARCEL POST

# RESISTANCE and WATTAGE

*marked on every unit!*



## OHMITE Little Devil composition resistors

• It's a simple matter, now, to make sure you're getting the resistance and wattage you want. Just ask for Ohmite Little Devils. Every unit is not only color-coded but individually marked for quick positive identification. Ohmite Little Devil resistors are available in standard RMA values from 10 ohms to 22 Megohms, in 1/2, 1, and 2-watt sizes. Tol.  $\pm 10\%$ . Also  $\pm 5\%$  in 1/2 and 1-watt sizes.

Available Only Through Ohmite Distributors

*Other*  
**OHMITE  
ITEMS...**

### TYPE AB POTENTIOMETER

New high quality 2-watt molded composition unit with good safety margin  
*Sold only by Ohmite distributors.*



### BROWN DEVIL RESISTORS



Rugged, dependable, wire-wound, vitreous-enameled. Easily mounted by tinned wire leads. Tol.  $\pm 10\%$ . Five, 10, 20-w sizes.

### DIVIDOHM ADJUSTABLE RESISTORS

Used as multi-tap resistors or voltage dividers. Provides odd resistance values quickly. Vitreous-enameled.



### NEW OHM'S LAW CALCULATOR

Solves any Ohm's Law problem with one setting of slide. Send now—25¢.



### WRITE FOR CATALOG 19

Provides useful data on selection, application, of rheostats, resistors, tap switches, chokes, etc.



## OHMITE MANUFACTURING CO.

4894 Flournoy Street, Chicago 44, Ill.

*Be Right with*

# OHMITE

RHEOSTATS • RESISTORS • TAP SWITCHES

## WORLD-WIDE STATION LIST

(Continued from page 40)

All Schedules are Eastern Standard Time

Location	Station	Freq.	Schedule
ALASKA	WXFD	12.250	1800 to 0100
ALBANIA			
Tirana	ZAA	7.850	1400 to 1800
ALGERIA			
Aigiers		6.040	1230 to 1800
Aigiers		9.540	1230 to 1700
Aigiers		11.830	0630 to 0300; 1200 to 1900
ANDORRA			
ANGOLA			
Benguela	CR6RB	9.160	1330 to 1430
Louanda	CR6RA	9.470	0115 to 0230; 0630 to 0745; 1400 to 1530
ARGENTINA			
Buenos Aires	LRSI	5.980	1800 to 2300
Buenos Aires	LRV1	6.090	0545 to 0715; 1800 to 2100
Buenos Aires	LRV1	9.680	1600 to 1630
Rosario	LRR	11.980	0600 to 1800
AUSTRALIA			
Brisbane	VLQ2	7.210	0230 to 0630
Brisbane	VLQ	7.240	1500 to 1900
Melbourne	VLQ	9.580	1100 to 1200
Melbourne	VLG3	11.710	0100 to 0145; 0230 to 0345
Melbourne	VLG6	15.230	2100 to 2300
Perth	VLW7	9.520	0530 to 1030; 1700 to 2045
Shepparton	VLQ8	7.280	1015 to 1045
Shepparton	VLR	9.540	1620 to 1900; 2045 to 0220
Shepparton	VLQ6	9.810	0830 to 1200
Shepparton	VLB2	9.680	0900 to 1100
Shepparton	VLG7	11.840	0800 to 0915
Shepparton	VLG4	15.310	N. American beam, 2045 to 2145; 0010 to 1145; Asiatic beam, 1730 to 1800; Philippine beam, 1900 to 1915
AUSTRIA			
Vienna		7.160	0600 to 0200; 0600 to 0800; 1000 to 2030
Vienna		9.820	2345 to 2030
Vienna		12.210	1145 to 2030
AZORES			
Ponta del Gada		4.040	1700 to 1900
Ponta del Gada		11.090	1500 to 1600
BELGIAN CONGO			
Leopoldville	OTC	9.380	0000 to 0200; 1045 to 1600
Leopoldville	OTC	9.740	1300 to 2015
Leopoldville	OTC	11.720	0530 to 0730
Leopoldville	OTC	17.770	0500 to 0830; 1130 to 1215
BOLIVIA			
Cochabamba	CP40	6.510	1930 to 2200
La Paz	CP49	6.770	0700 to 0900; 1100 to 1200; 1730 to 2100
BORNED			
Balikpapan		9.120	0700 to 0935
Belem	PRC5	4.860	0600 to 1100; 1530 to 2000
Fortaleza	PRE9	6.100	1530 to 2100
Rio de Janeiro	ZYC8	9.610	1500 to 2200
Rio de Janeiro	PRL7	9.720	0430 to 0600; 1415 to 1445; 1500 to 2100
Rio de Janeiro	PSH	10.220	1700 to 1800
Rio de Janeiro	PRL8	11.720	heard at 0300
Sao Paulo	ZYB7	6.090	1600 to 1950
BRITISH GUIANA			
Georgetown	ZFY	6.000	0545 to 0745; 0945 to 1145; 1415 to 1945
BRITISH SOMALILAND			
Hargeisa		7.130	0800 to 1030; 1200 to 1300
BRITISH WEST INDIES			
Jamaica	ZQI	3.480	1600 to 2200
BURMA			
Rangoon		6.040	0630 to 0230; 0645 to 0830; 2100 to 2145
CANADA			
Calgary	CFYP	6.030	0730 to 0100
Edmonton	CJCA	9.540	0815 to 0200
Montreal	CFCX	6.000	0700 to 2315
Montreal	CBFW	6.090	0730 to 1945; 2000 to 2400
Montreal	CKLO	9.630	1600 to 1800
Montreal	CKCX	15.190	0800 to 1200
Montreal	CKNC	17.820	0830 to 1500
Montreal	CKFR	6.070	0600 to 2345
Toronto	CKFX	6.080	0930 to 0300
Vancouver	CBRX	6.160	0900 to 0200
Vancouver	CJRO	6.150	2200 to 0300
Winnipeg	CKRX	11.720	1000 to 2000
CANAL ZONE			
Quarry Heights		2.390	0530 to 0700; 1000 to 2305
CANARY ISLANDS			
Santa Cruz	EAJ43	7.570	0630 to 0800; 1100 to 1200; 1230 to 1800
CEYLON			
Colombo		3.390	0600 to 1200
Colombo		6.070	0715 to 1200; 1930 to 0545
CHILE			
Santiago	CEI174	11.740	1700 to 2400
Santiago	CEI180	12.000	0600 to 0800; 1600 to 2300
CHINA			
Canton	XTPA	11.650	0400 to 0915
Chungking	XGOY	7.150	0630 to 1130
Chungking	XGOY	9.650	0630 to 1030
Chungking	XGOA	9.730	0900 to 1030
Chungking	XGOY	11.800	0500 to 0630; 1045 to 1145
Foochow	XGOL	10.000	0400 to 1090
Kweliyang	XPSA	7.010	2330 to 0030; 0430 to 0900
Shanghai	XGRS	11.690	0300 to 0930; 1830 to 2400
COLUMBIA			
Armenia	HJFH	4.880	0600 to 2200
Barranquilla	HJAB	4.780	1700 to 2255
Bogota	HJCA	4.850	1900 to 2200
Bogota	HJCH	4.890	1800 to 2200
Bogota	HJCV	4.940	0645 to 1115; 1600 to 2315
Bogota	HJCQ	4.950	1000 to 1400; 1700 to 2300
Bogota	HJCX	6.020	0700 to 0800; 1400 to 2315
Bogota	HJCD	6.160	0700 to 0800; 1600 to 2330
Bogota	HJCT	6.200	1000 to 1400; 1800 to 2315
Bogota	HJCF	6.240	1700 to 2300

(Continued on page 60)

# New SUPREME 1948 and F.M. Manuals



## BIGGEST BARGAIN IN RADIO DIAGRAMS

Make these two new mammoth volumes your money-saving source for data on all recently released receivers. Learn about modern circuit developments, be ready to repair any new radio no matter how complex. You pay only \$2.00 for each of these large manuals. With these two volumes on your workbench there is nothing else to buy, nothing else to pay—a whole year of radio diagrams and service data yours for a couple of dollars total. Again Supreme Publications beats all competition and gives radio servicemen greatest bargains in service information. Read about other volumes for previous years described at the left and below. **No-risk** examination granted to servicemen.

### F.M. and Television

Use this giant-size manual of factory instructions for troubleshooting, repairing, and alignment of any recent F.M. and Television set. Covers every popular make, including F.M. tuners, AM-FM combinations, and all types of television receivers. Detailed circuit diagrams, theory of operation, test hints, alignment data. This is the material you need to fix any modern F.M. or Television set. Don't turn this profitable work away for lack of knowledge and information. Use his newest Supreme manual to save time and money on your very next F.M. job. Data presented in 192 large-size pages, 8½ x 11 in. sturdy, manual-style binding. Special price. **\$2.00**

### New 1948 Manual

Be prepared to repair quickly all new 1948 receivers. In this big single volume you have clearly-printed, large schematics, needed alignment data, replacement parts lists, voltage values, and information on stage gain, location of trimmers, and dial stringing, for almost all recently released sets. A worthy companion to the 7 previous volumes used by over 120,000 shrewd radio servicemen. New manual covers models of 42 different manufacturers. Giant size: 8½ x 11 in. 192 pages + index.

Manual-style binding. **\$2.00**  
Bargain price, only...

## FIND ALL RADIO FAULTS DOUBLE-QUICK

You can speed-up and simplify radio repairs with SUPREME PUBLICATIONS Manuals. Service radios faster, better, easier, save time and money, use these most-often-needed diagram manuals to get ahead, earn more per hour. For the remarkable bargain price (only \$2 for most volumes) you are assured of having in your shop and on the job, needed diagrams and other essential repair data on 4 out of 5 sets you will ever service. Every popular radio of all makes from old-timers to new 1948 sets, including F.M. and Television, is covered. Clearly printed circuits, parts lists, alignment data, and helpful service hints are the facts you need to improve your servicing ability. Save hours each day, every day, begin to earn more by making repairs in minutes instead of hours. Let these manuals furnish you with diagrams for 80% of all sets. There is no need to spend large sums for bulky, space-wasting manuals, or to buy additional drawings every few weeks; be wise, use SUPREME Manuals to get the most in diagrams and service data for the smallest cost.

## SUPREME DIAGRAM MANUALS



1947 1946 1942 1941 1940 1939 1926-38  
**MOST-OFTEN-NEEDED RADIO DIAGRAMS** **DIAGRAMS**  
Each manual has between 192 and 208 pages of diagrams and service hints; large size, 8½x11". Price, each. **\$2.00** 240 Pages Price \$2.50

### Post-War Automatic Record Changers

Service expertly all new (1945-1947) record changers. Follow simplified factory instructions to make needed adjustments and repairs. Hundreds of photographs and exploded views; thousands of test hints; service instructions for all popular makes. Large size: 8½ x 11". 144 fact-filled pages. **\$1.50**  
At your jobber or postpaid, only.....

### Pre-War Record Players, Changers, & Recorders

Just what you need to repair quickly thousands of pre-war automatic record changers, manual units, pick-ups, wireless oscillators, recorders, and combinations. Hundreds of mechanical and electrical diagrams. Instructions for adjustments and repairs. Most popular units of all makes. 128 large pages. 8½x11 inches. **\$1.50**  
Price, only.....

## SATISFACTION GUARANTEED

**Most Popular Models Made by:**  
R.C.A., Zenith, Philco, Sears, Fada, Emerson, Belmont, Detrola Radio, Majestic, United Motors, G.E., Westinghouse, Arvin, Stewart-Warner, Admiral, Delco, Stromberg-Carlson, Western Auto, Wards, Sperton, Motorola, Gamble, Crosley, and many others.

Select the Diagram Manuals and Record Changer Books you want to examine. See listing in left-hand column. Send the convenient no-risk trial coupon. Use the manuals in your own home or shop for 10 days at our risk. You must be completely satisfied, or return manuals and receive your money back. Write today—24-hour service.



Compiled by M. N. Beltman, radio engineer, teacher, author, & serviceman.

## NO RISK TRIAL ORDER COUPON

SUPREME PUBLICATIONS, 9 S. Kedzie Ave., Chicago 12, ILL.

Ship the following manuals on trial under your guarantee of satisfaction or money-back.

- New F.M. and Television Manual @ \$2.00
- Post-War Record Changers..... @ 1.50
- Pre-War Record Players..... @ 1.50

I am enclosing \$....., send postpaid.

Send C.O.D. I am enclosing \$..... deposit.

- 1948
  - 1947
  - 1946
  - 1942
  - 1941
  - 1940
  - 1939
  - 1926-1938 @ \$2.50
- PRICED AT ONLY \$2.00 EACH**

Name: .....

Address: .....

SEND COUPON OR WRITE ORDER IN A LETTER

# Supreme Publications

PUBLISHERS OF RADIO BOOKS, MANUALS, AND DIAGRAMS

9 South Kedzie Ave.

Chicago 12, Illinois

RADIO-CRAFT for FEBRUARY, 1948

## Multiple Range Continuous Indicating PORTABLE TACHOMETER

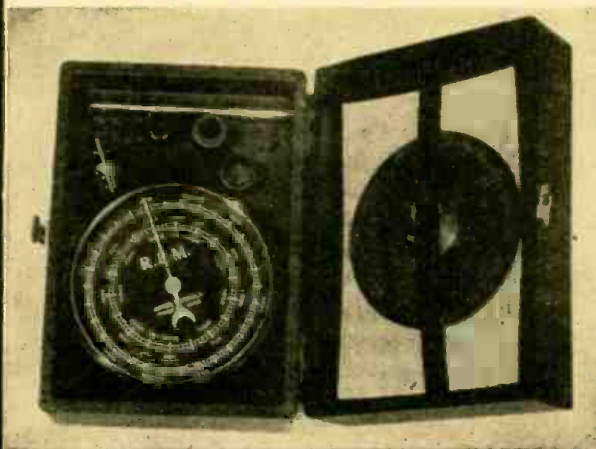

- Ball bearing and oilless bearings — require no lubrication whatsoever.
- Readily portable—Fits neatly into palm of hand.
- Gear shift for selecting low, medium and high ranges.
- Greatest accuracy—meets Navy specifications 18-T-22, Type B, Class A.
- Complete with the following accessories:
  - 1—Steel tip
  - 1—Conical Rubber tip metal mounted
  - 1—Rubber lined metal cone tip

- Three ranges in R.P.M., and three ranges in F.P.M.
    - Low Range .. 300-1,200 (Each division equals 10 R.P.M.)
    - Medium Range 1,000-4,000 (Each division equals 20 R.P.M.)
    - High Range 3,000-12,000 (Each division equals 100 R.P.M.)
  - Large open dial 4" diameter.
  - Ruggedly constructed for heavy duty service.
- 1—Peripheral Rubber wheel 1 ft. in circumference  
 1—Extension Rod  
 1—Small size convex rubber tip, metal mounted  
 1—Operating instruction
- Made by Jones Motrola, Stamford, Connecticut. Comes complete in blue velvet lined carrying case; 7 1/2" L x 4" H x 5" W. List Price \$75.00—Surplus—New—Guaranteed.

**Your Cost \$24.50 fob. N. Y.**

## Portable (Chronometric) TACHOMETER

Jaeger Watch Co. Model #43A-6

- Can be used for speeds up to 20,000 R.P.M.
- Can be used for lineal speed measurements to 10,000 F.P.M.
- Ideally suited for testing the speeds of motors, particularly of fractional horse power, generators, turbines, centrifugals, fans, etc.
- Very small Torque—requires practically no power to drive.
- Unequaled Readability 2" Open face dial—each division on large dial equals 10 R.P.M.; each division on small dial equals 1,000 R.P.M.
- Greatest Accuracy—meets Navy specifications—guaranteed to be within 1/2 of 1%.
- Results of test reading remain on dial until next test taken.
- Push button for automatic resetting.
- Complete with the following accessories:
  - 1—Large pointed rubber tip
  - 1—Large hollow rubber tip
  - 1—6" circumference wheel tip
  - 1—Operating Instructions
  - 1—Temperature Correction chart

The combination of the above features will give accurately, within a few seconds, by direct reading, the R.P.M. of shafts or the lineal speeds of surfaces without any accessories or timing of any kind. Each unit comes complete in a red velvet lined carrying case 5" x 3 1/2" x 1 1/2" (case and accessories not illustrated). Net List Price, \$75.00—Surplus—New—Guaranteed.

**Your Cost \$24.50 fob, N. Y.**



- D.C. MOTOR**—Permanent Magnet Type 10,000 R.P.M. Deleo Type #5089370 27.5 Volt D.C. 2 1/2" Long (1/2 shaft) x 1" W x 1 1/2" H HkH ..... \$4.95
- Signal strength ("S") Meter**—Simpson 25, 3 1/2", rd fl bake case. Use this on the plate circuit of your receiver to show the relative strength of incoming signals. Sc calibrated—8 to 100 DB above 1 microvolt. 5 MA Zero right mvst with translucent sc, for internal sc illumination from rear of meter. Comp with socket, lamp and leads. For further details refer to pages 184-185 & FIG. 730 B of Radio Amateurs' Handbook ..... \$4.50
- O.C. Microammeters**—W.E., 100-0-100 microampere, approximately 950 ohms resistance, 3 1/2", rd fl bake case, concentric style ..... \$6.50
- OB Meter**—W.H. RC-35—minus 10, plus 6 ODB—1.897 V. 6 MW—600 ohms—3" square ..... \$4.50
- A.C. Voltmeters**—W.H., NA-35, 15 V. (100 MA) 3 1/2", rd fl bake case ..... \$3.95
- W.H., NA-35, 150 V (10 MA) 3 1/2", rd fl bake case ..... \$5.50

### CODE TRAINING SET AN/GSC-T1

Made by T.R. McElroy, Boston  
 Operates off 6, 12, 24 or 110 V DC. or 110 V or 230 Volt, 60 cycle.

An excellent unit for schools or clubs for code training. This unit is designed for group training of telegraph code to students whereby each student sends a message from any prepared text to the instructor. It provides a visual signal through a blinker or an audible signal through a monitoring speaker. Has volume control, variable frequency oscillator, a phone jack for a monitoring headset, pitch and tone control, rotary switch for selecting the operating voltage and power supply.

Complete with spare fuses, power cord and battery adapter; 10 Telegraph Keys with 10' line each. 1 #6x5 tube and 2 #6AG6 tubes.  
 Complete in chest 10 1/2" x 17" L x 13 1/2" H—Net wt. 40 lbs.

Can be used anywhere—batteries, A.C. or D.C.  
 Durable—Good for a lifetime of Service!

**NET \$24.50**

All Items are Surplus—New—Guaranteed. C.O.D.'s not sent unless accompanied by 25% Deposit. Orders accepted from rated concerns, Public Institutions, etc., on open account. The above is only a partial listing of the many items we have in stock. Send for free circular.

## MARITIME SWITCHBOARD

336 Canal Street

Worth 4-8217

New York 13, N. Y.

## WORLD-WIDE STATION LIST (Continued from page 58)

Cartagena	HJAP	4.920	0600 to 1300; 1700 to 2200
Cartagena	HJAE	4.960	1600 to 2230
Call	HJED	4.820	1900 to 2300
Cucuta	HJBB	4.810	1700 to 2200
Medellin	HJDE	6.140	1100 to 2300
<b>COSTA RICA</b>			
San Jose	TIRH	6.150	2130 to 2400
San Jose	TIPG	9.610	0700 to 2330
<b>CUBA</b>			
Camaguey	COJK	8.720	2000 to 0030
Havana	COBF	6.040	0800 to 2300
Havana	COCD	6.130	0700 to 2400
Havana	COCV	6.330	0600 to 2400
Havana	COCO	8.700	0700 to 2330
Havana	COBQ	8.830	0530 to 0030
Havana	COBZ	9.030	0700 to 0100
Havana	COBQ	9.230	0800 to 1200; 2000 to 2200
Havana	COCX	9.270	0700 to 0030
Havana	COBC	9.380	0700 to 2400
Havana	COBL	9.830	0715 to 0045
Havana	COCY	11.740	0630 to 0100
Santa Clara	COHI	6.450	0700 to 2345
Santiago	COKG	8.950	1830 to 2325
<b>CURACAO</b>			
Willemstad	PJCI	7.250	1130 to 1230; 1630 to 2130
<b>DENMARK</b>			
Copenhagen	OZF	9.520	1830 to 1800
<b>DOMINICAN REPUBLIC</b>			
Ciudad Trujillo	HIIN	6.240	1600 to 2230
Ciudad Trujillo	HIIZ	6.310	1600 to 2255
Montsignor	HIIT	6.480	1600 to 2400
Santiago	HIHA	6.190	1600 to 1800
<b>ECUADOR</b>			
Cuenca	HCSEH	3.930	1800 to 2230
Quito	HCJB	4.100	1800 to 2230
Quito	HCJB	6.280	1800 to 2230
Quito	HCJB	9.960	0545 to 0845; 1200 to 2230
Quito	HCJB	12.440	0600 to 1000; 1400 to 2330; Sundays, 0700 to 1630; 1700 to 2200
Quito	HCJB	15.110	0500 to 1200; 1330 to 2230
<b>EGYPT</b>			
Calro	JCPA	7.190	1500 to ?; 2230 to 2400
Calro	SUX	7.860	0200 to 0300; 1200 to 1600
<b>ENGLAND</b>			
London	GRR	0.070	2300 to 0030
London	GSL	6.110	1500 to 1745; 1900 to 0030
London	GRW	6.150	1445 to 1500; 1900 to 2215; 2330 to 2345
London	GRM	7.120	1145 to 1215; 1445 to 1515
London	GSW	7.230	0100 to 0115; 0130 to 0330; 0600 to 0645; 0700 to 0730; 0745 to 0900; 1045 to 1130; 1230 to 1430; 1530 to 1715
London	GWJ	7.250	0100 to 0200; 0630 to 0645; 0700 to 0800; 0815 to 0900; 1045 to 1300
London	GSU	7.260	1330 to 1700; 2345 to 2400
London	GRJ	7.320	0000 to 0015; 0645 to 0700; 1045 to 1815
London	GSC	9.580	1100 to 1315; 1330 to 1415; 1430 to 1530; 1615 to 2300; 2345 to 0030
London	GRY	9.600	1230 to 1600; 1800 to 2230; 2300 to 0030
London	GW0	9.820	0045 to 0130; 0200 to 0300; 0600 to 0630; 0700 to 0900; 1045 to 1400; 1700 to 2030
London	GVZ	9.640	0100 to 0500; 1500 to 1730; 1800 to 2230
London	GRH	9.820	1215 to 1600; 1700 to 2300
London	GRG	11.680	0600 to 0645; 0700 to 0900; 1000 to 1130; 1145 to 1200; 1230 to 1430
London	GVW	11.700	0000 to 0715; 0830 to 1015; 1130 to 1600; 1800 to 2230; 2300 to 0030
London	GSD	11.750	1215 to 1600; 1615 to 1900
London	GSN	11.820	2300 to 0030; 0100 to 0300; 1030 to 1430; 1700 to 2030
London	GVX	11.930	0515 to 0530; 0600 to 0630; 0700 to 0730; 0745 to 0900
London	GRF	12.090	2300 to 1615; 1700 to 2030
London	GWG	15.110	0000 to 0400; 0600 to 1015; 1100 to 1315; 1500 to 1600
London	GSO	15.180	2300 to 1200; 1230 to 174
London	GSI	15.260	0400 to 0430; 1030 to 140
London	GWR	15.300	0600 to 0900; 1045 to 1330; 1400 to 1430; 1700 to 1800
London	GSP	15.310	2345 to 0030; 0100 to 0500; 0600 to 0815; 1200 to 1315; 1615 to 1845
London	GRD	15.450	0100 to 0500; 0600 to 0700; 1700 to 1845
London	GVP	17.700	Middle East beam, 0800 to 1115; 1200 to 1800
London	GRA	17.710	New Zealand and Australia beam, 0600 to 0815
London	GVQ	17.730	0100 to 0500; 0800 to 121
London	GSF	17.780	New Zealand beam, 0500 to 1030
London	GSV	17.810	0100 to 0400; 0500 to 143
London	GRQ	18.020	0100 to 0500; 0830 to 0845; 0900 to 1430
London	GV0	18.080	1030 to 1245; 1300 to 150
London	GSH	21.470	0500 to 1215
London	GSI	21.530	Indian beam, 0500 to 081
London	GST	21.550	1030 to 1130
London	GRZ	21.640	Central American beam, 0600 to 0900
London	GVT	21.750	0100 to 0500; 1030 to 113
London	GSK	26.100	0615 to 1000

# BUILD YOUR OWN QUALITY TEST EQUIPMENT

## The NEW HEATHKIT VACUUM TUBE VOLTMETER KIT



**\$24.50**

The most essential tool a radio man can have, now within the reach of his pocketbook. The Heathkit VTVM is equal in quality to instruments selling for \$75.00 or more. Features 500 microamp meter, transformer power supply, 1% glass enclosed divider resistors, ceramic selector switches, 11 megohms input resistance, linear AC and DC scale, electronic AC reading RMS. Circuit uses 6SN7 in balanced bridge circuit, a 6H6 as AC rectifier and 6X5 as transformer power supply rectifier. Included is means of calibrating without standards. Average assembly time less than four pleasant hours, and you have the most useful test instrument you will ever own. Ranges 0-3, 30, 100, 300, 1000 volts AC or DC. Ohmmeter has ranges of scale times 1, 100, 1000, 10M and 1 megohm, giving range .1 ohm to 1000 megohms. Complete with detailed instructions. Add postage for 8 lbs.

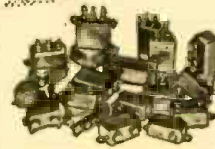

**BATHTUB  
CONDENSER KIT**  
1 MFD. to 1. MFD.  
up to 600 Volt.  
**20 FOR \$1.00**

### TRANSMITTER CRYSTAL KIT

4 mounted crystals between 2 MC and 3 MC.  
**4 FOR \$1**



### SOCKET KIT

20 beautiful octal, loctal and miniature sockets.  
**20 FOR \$1**



### R.F. CHOKE KIT

Perfect sizes from 1/2 to 2 1/2 MH.  
**10 FOR \$1**



### POWER RHEOSTAT KIT

All knob types in 25 and 50 watt I.R.C., etc.  
**5 FOR \$2.95**



### MICA CONDENSER KIT

An excellent assortment with silver mica and regular. All color coded or marked.  
**25 FOR \$1.00**



### CERAMIC CONDENSER KIT

20 beautiful condensers all marked or coded, many zero temp. coef. types.  
**20 FOR \$1.00**



### RESISTOR KIT

The best available all insulated color coded in 1/2-1-2 watt sizes.  
**100 FOR \$1.95**



### OUR BEST CONDENSER BUY

An ideal power supply filter has 2.5 MFD., 2.5 MFD., and 5 MFD., sections at 600 V. working. All oil filled, extra special. **95c**



### CONDENSER SPECIAL

Brand new standard brand 2 MFD. 600 V. oil filled filter condensers, porcelain insulators.  
**3 FOR \$1.00**



### COMMAND SET ACCESSORIES

110V power supply kit with 24 volt filament, no wiring changes inside set, punched chassis and volume control **\$5.95**  
5" PM speaker with output transformer, matching headphone output **\$2.80**  
Dual receiver rack FT2277A with connecting plugs **\$1.00**  
Shock mount for above rack **\$1.00**  
Single transmitter rack FT **\$1.00**

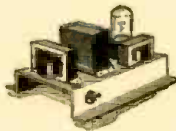

### T32 TABLE MICROPHONE

One of the Army's best. Built by Kellogg, ideal for factory call system, public address, amateur use. Brand new in original cartons, add postage for 5 lbs. **\$2.95**



### DC POWER SUPPLY KIT

Supplies 24 V D.C. at 100 MA from 110 V A.C. for operating 24 V electric motors - trains, etc. Complete ready to build. **\$2.49**



### MINIATURE ELECTRIC MOTOR

only 1 1/4" x 1" x 2" 6000 RPM. **\$2.95**



### G.E. CIRCUIT BREAKER

Protect your equipment at one-fourth of cost, new G.E. 50 amp. 220 V. circuit breakers. **\$2.95**



### 2 1/2" VOLTMETER

Ideal for making pocket tester, scale 0-3 D.C. volts, made by Weston and Simpson. Tester diagram and Multiplier Resistors for 30-300 V. D.C. included. **\$1.95**



### MILITARY POWER TRANSFORMERS

Convert your military receivers without rewiring the filament. "A" type supplies 500 VCT at 50 MA, 5V at 2A and 24V at 1/2A. "B" type supplies 500 VCT at 50 MA, 5V at 2A and 12V at 1 amp. State whether A or B type desired. **\$2.95**



### AIRCRAFT INTERPHONE AMPLIFIER

New BC 347C using 6F8 tube with tube uncner, transformers, diagrams, etc. **\$2.95**



### TRIMMER CONDENSER KIT

10 brand new variables 12 MMF to 50 MMF ceramic Insulated. **\$1.95**



### 455 KC I.F.'s

Dual slug tuned square can.  
**3 FOR \$1**



## The NEW 1948 HEATHKIT 5 INCH OSCILLOSCOPE KIT

New improved model of the famous Heathkit Oscilloscope. Building an oscilloscope is the finest training for television and newer servicing technique and you save two-thirds the cost. All the features and quality of instruments selling for \$100.00 or more. Supplied complete with cabinet, two color panel, 5BP1 tube, 2 5Y3 tubes, 2 6SJ7 tubes and B84 sweep generator tube. Power transformer supplies 1000V negative and 350 volt positive. Sweep generator 15 cycles to 30 M. cycles. Has vertical and horizontal amplifiers. Oil filled filter condensers for long life. Nothing else to buy, complete blueprints and instructions included.



*Only*

**\$39.50**

**NO ORDERS UNDER \$2.00**  
We will ship C.O.D.  
Add postage, we refund excess



**The HEATH COMPANY**

DEPT. C. • BENTON HARBOR, MICHIGAN



The Name that Means Radio Bargains . . .

GET ON OUR MAILING LIST—ALWAYS SOMETHING NEW PROMPT EXPERT SERVICE ON ALL SPEAKER AND PHONE REPAIRS

4" PRECISION ETCHED DIAL. Calibrated 0-100 over 180° Plated brass. 3/4" hole, set screw . . .39

EXPERIMENTAL TUBES. 20 asstd. receiving types for testing, research, etc. Filament tested. . .\$1.00

AUDIO TRANSFORMER. 3:1. DC resist. 800/7000. Hermetically sealed. Base mtk., 2"x1 1/2"x1 1/2". . .69

RCA VICTOR POWER TRANSFORMER for models R-32, 45, 52 or 75. Unshielded. . .\$5.95

PUSH BUTTON ASSEMBLY. 5 position, D.P., circuit transfer. 5" long, 1 1/2" deep, 3/4" shafts. . .69  
With set of 5 matched bakelite knobs. . .95

TELEVISION SAFETY WINDOW for 7" tube. Clear hvy. convex plastic. Moulded flange for mtg. . .49

CHANGER BASE SLIDERS. Smooth ball-bearing 10 1/2" extension. With brackets for side or bot. mtg. . .Per pair \$1.98

BLANK CHASSIS. 6 1/2"x4"x1 1/2". Rustproofed steel . . .29

120" WHIP ANTENNA. 3 steel screw-in sections, weather-proofed, with hvy. duty spring type mtg. base . . .\$1.98

1/4" LINEN BAKELITE STRIPS. 13 1/2"x1 1/2". 3 for .25

**KENYON TRANSMITTING TRANSFORMERS**

KENYON TRANSMITTING TRANSFORMERS. Hvy. duty components, designed for AMATEUR & P.A. use. All fully shielded.

MODULATION Transformer (#B46-RF). Couples P.P. Class B 46's or 50's to 4000 ohm RF load. 20W. Mtg. 2"x4 1/2". Shpg. wt. 6 lbs. \$2.25

OUTPUT Transformer (#B2470). Couples single 6F6, 2A5, etc., to 4, 8 or 15 ohm voice coil. 15W. Mtg. 2"x3 1/2". Shpg. wt. 4 lbs. \$1.98

OUTPUT Transformer (#B203RFA). Couples P.P. Class B 203A's to 2500 ohm RF load. 50W. Mtg. 2 1/2"x6 1/2". Shpg. wt. 11 lbs. \$2.49

RG-8/U COAX. 52 ohm, 4 ft. lengths with two PL-259 connectors . . .39

ANTENNA LOOPS. High gain, spider wound. 8 1/2"x4 1/4" . . .29

PRECISION RESISTORS



±1% WIRE-WOUND

(Standard Brands, etc.) Ohmages: 2.35, 11, 24.5, 100, 130, 405, 840, 1740, 2500, 3300, 5290, 7800, 30K, or 50K . . .ea. 35c; 3 for \$1.00  
MEGOHMS: .1, .125, .2, .25, .4, .5, .6, .75 . . .ea. 49  
SPECIAL!!—1 MEGOHM (IRC) . . . . .ea 75c

DYNAMIC MIKE & HEADSET (B-19). Both are sensitive moving coil type. Adj. rubber cushioned phones; Press-to-talk hand mike. Brand new

\$2.69

Dynamic headset only \$1.75  
Hand mike only \$1.29

"Here's a Leotone Super-Special"

**HIGH POWER ANTENNA TUNER**

Brand new units. Range: 1500-7000 Kc. Easily converted to higher freq. Grey metal case contains: 20-75 ma silver-plated variometer (O.D. 4 1/2"x8"), edge-wound with separate induct. & coupling ticklers. Hvy. duty 250 mmf. 7000V Johnson variable (4" sq. x 1 1/2"); 3" sq. Triplet 0-8 RF meter & Thermocouple. With instruction book. 15"x15"x23". Shpg. wt. 45 lbs. . . . \$14.95



**ALNICO MAGNETS**

POWERFUL ALNICO MAGNETS in many sizes & shapes always in stock. Write for latest illustrated supplement, Feb. Special—Round bar, plshd. poles O.D. 3/8"x2".

TUBES: Perfect condition, but in unsealed cartons. Mdst types in stock at up to 80% off list. Every tube guaranteed 90 days.  
#20, 27 or 40 . . . . .39  
#75, 75, 77, 78, 89, 5Y3, 6H6 or 6K7 . . . . .49  
#35, 36, 37, 38, 5Y4, 6C5, 6F5, 6J7, 6U7, 6V6, 6SA7, 6SK7 or 12SK7 . . . . .49  
#1A7, 1H5, 1N5, 1R5, 6A3, 6U5, 6X4, 7A7, 7C5, 7C6, 7Y4, 80, 80B5 or 50L8 . . . . .59  
TUBE CARTONS: Plain white  
Miniature (1 1/2" sq. x 2 1/2") Per 100 . . . . . \$ .98  
GT size (1 1/2" sq. x 3 1/2") Per 100 . . . . . \$1.25  
Medium (1 1/2" sq. x 4 1/2") Per 100 . . . . . \$1.49  
Large (2" sq. x 5") Per 100 . . . . . \$1.79  
Min. Order \$2.00—20% Deposit Required on All Orders. Please Add Sufficient Postage. WRITE DEPT. RC-2.

**NEW "JUMBO" RADIO PARTS ASSORTMENT**

AMATEUR'S! SERVICEMEN! EXPERIMENTERS! Don't miss this outstanding buy in new & dismantled radio & electronic parts! 17 FULL POUNDS OF COILS, TRANSFORMERS, WIRE, RESISTORS, HARDWARE, CONDENSERS, SPEAKER ACCESSORIES, CHASSIS, SUB-ASSEMBLIES, etc., etc.

All these and more for only \$2.95

**HANDY RADIO PARTS KITS**

- #1—R.F. ANTENNA & OSC. COILS. 10 asstd. . . . .98
- #2—SPEAKER CONES. 12 asstd. 4" to 12" moulded & free-edge (magnetic incl.). Less voice coils. . . \$2.00
- #3—MOULDED BAKELITE CONDENSERS. 50 asstd. .0001 to .2mfd, 200-600V. Clearly marked . . . . . \$2.95
- #4—TUBULAR BY-PASS CONDENSERS. 50 asstd. .001 to 2 mfd, 200-600V. Standard brands . . . . . \$2.49
- #5—WAFFER SOCKS. ETS. 12 asstd. 4 to 7 prong . . . . .25
- #10—VOLTAGE DIVIDERS. 10 asstd. standard, multi-tapped. High wattages incl. . . \$1.98
- #12—MICA PADDERS & TRIMMERS. 15 asstd. incl. multiple & ceramic base . . . . .69

**LEOTONE RADIO CO.**  
MAKERS OF CONES AND FIELD COILS  
65-67 DEY STREET, NEW YORK 7, N.Y.  
WORTH 2-0284-5  
12,000 SQ. FT. OF RADIO PARTS

**TRANSATLANTIC NEWS**

(Continued from page 38)

with. At first sight this appears paradoxical: why bother about reproducing sounds that the ear cannot hear? But everyone with a sensitive and musical ear admits that there is something lacking even in reproduction reputed to bring out all frequencies in the normal audible range up to, say, 16,000 cycles. Possibly the very high inaudible harmonics of certain instruments in an orchestra beat together and produce audible sounds corresponding to the difference between these frequencies. Such beat frequencies are necessary for genuinely faithful reproduction and they

cannot of course be there unless the ultra-audio frequencies which give rise to them are reproduced.

That seems quite likely, but it is also certain that the ordinary radio listener will never develop any real enthusiasm for the very high audio frequencies until we have found some means of eliminating harmonic distortion from our loudspeakers. Second-harmonic and third-harmonic distortion are most distressing to the ear. The only way to reduce their effects in the ordinary broadcast receiver of today is to turn the tone-control knob well toward the "mel-

low" position—thus cutting out all frequencies above about 4,000!

**Parallel transmitters for power**

It is now possible for the first time to describe a remarkable new system of obtaining very large power outputs for broadcasting by linking several similar transmitters together, which was developed during the war by the BBC. It became urgently necessary to install a 400-500-kw station, both to ensure coverage of the whole country in case existing transmitters were damaged by enemy bombing and to conduct news services for enemy-occupied European countries. The only transmitters available were several 150-kw units. These units could be "pepped up" to 200 kw and it was decided to devise means of combining the outputs of two of them to produce a transmitter with a power output in the region of 400 kw from the common antenna system. Results were so entirely satisfactory that 4 units were later teamed up on a site near Hull on the northeast coast to form an 800-kw transmitter for the European services. Today the BBC has adopted the linked-unit system as standard for the new medium- and long-wave stations.

Many difficulties had to be overcome. It is simple to match the carrier frequencies of 2 or more units by driving them from a common oscillator; but it is another matter to ensure that the output r.f. voltages are equal and in phase, as they must be. Further, the phase and amplitude of the modulation in the outputs must be made and kept precisely the same. Another thorny problem was that of the breakdown of one of the units; unless automatic safety devices could be provided, the transmitters remaining alive would be working into an incorrect load impedance and would feed r.f. power into the dead unit. These snags were overcome. A variable phase-shifting network is inserted in the low-power circuits between the common crystal drive and the drive input of each unit. When phasing-up, each unit's output is run up to full power on a test load. A signal derived from a transformer in the test load is applied to one pair of plates of a c.r. tube, a reference signal taken from the common drive being applied to the other pair. The phase shifter is then adjusted until the trace becomes a straight line at 45° to the vertical. An a.f. line-up follows. When all units have been dealt with, they are switched to the antenna bus-bar through a combining unit set to the correct load impedance, the main high-voltage supply being off. When all is ready, a ganged switch applied the high voltage to all units simultaneously. Should any unit break down when the team is in operation a drive-suppressor comes automatically into action and cuts the high voltage supply to all transmitters. Nor can they be restarted until the dead unit has been disconnected from the antenna bus-bar and the combining unit set to the new correct load impedance. One of the strong points of the system is that even complete breakdown of one transmitter causes only a momentary break in the program.



## 1—10 METER RECEIVER

(Continued from page 44)

a bowl of water, leaving only the pins exposed. The iron can be applied directly to the pins without damaging the polystyrene, which is under water.

After the leads are soldered, there is still a chance to make slight changes in frequency range by displacing the turns. After everything is satisfactory the turns are kept in place by applying Amphenol 912 coil dope, but don't use too much. This dope softens the polystyrene and ruins the appearance of the coil form when too much is used. We found a few drops at 3 or 4 places around each turn sufficient. Don't try to cover the entire winding. The dope can be used to tighten coil pins loosened by too much heat from a soldering iron. Apply a drop or two where the pin enters the polystyrene.

Less trouble will be experienced if the detector stage is completed and made to operate alone first, and the r.f. amplifier tackled afterward. The primary of the detector winding is used as temporary antenna coil.

The r.f. grid coils are wound to slightly less inductance than the corresponding detector coils so that the r.f. trimmer can be used for resonating.

### Superregeneration

When operating properly, the set should give no sign of oscillation when the regeneration control is at minimum. As the control is turned up there should be a short interval of continuous oscillation and finally (when the control is turned up still further) the hiss of superregeneration should be heard. If no superregeneration can be obtained, it may be necessary to increase the screen voltage to the detector or to readjust the feedback by changing the tap on the detector coil. The lower frequency bands will probably give no trouble in this respect.

There is a possibility that the r.f. stage may oscillate. This will also prevent the superregeneration from taking place. This is checked by removing the first 6AK5 or shorting out its grid coil. Make sure that the tube shields are in place and that all bypass condensers are well soldered with short leads. Of course the antenna should be connected when making these tests. The antenna is plugged into a banana jack at the right of the r.f. shield.

Miniature tubes should be inserted carefully in new sockets. These tubes are not too rugged since they have very thin pins which enter directly into the tube envelope. When too much force is used, the pins may bend and crack the tube. If a defective miniature tube is available, it is a good idea to insert it several times into the socket to "work it in."

### Operating the receiver

Although numerous mobile telephone, police, and aircraft messages may be picked up throughout the range of 2-12

(Continued on page 64)



**A. A. Ghirardi**  
**POSITIVELY**  
**GUARANTEES**  
*to help you repair any*  
**radio ever made EASIER**  
**BETTER & FASTER**

**or refund every cent of your money!**



**GUARANTEED**  
**TO HELP YOU LEARN**  
**Professional RADIO-**  
**ELECTRONIC REPAIR,**  
**at home, without**  
**an instructor**

**GUARANTEED**  
**TO HELP YOU REPAIR 9**  
**OUT OF 10 RADIO TROU-**  
**BLES Twice as Fast, without**  
**costly test equipment**



### A COMPLETE RADIO SERVICE COURSE . . . only \$5 Complete

Once in a lifetime, a technical book is written that is so important, so complete and easy to understand that it is used almost universally by members of an entire profession — and Ghirardi's MODERN RADIO SERVICING is exactly that kind of a book. It gives a complete course in radio-electronic repair work by scientific methods. Included is a thorough explanation of Test Instruments, how they should be used and why—even how to build your own; Receiver Troubleshooting Procedure and Circuit Analysis; Testing and Repair of All Components; Installations; Adjustments, etc., etc.—also How to Start and Operate a Successful Radio-Electronic Service Business. 1300 pages. 706 helpful illustrations. Self-Test Review Questions make study easy. Only \$5 (\$5.50 foreign).

### THIS BIG BOOK ELIMINATES NEEDLESS TESTING . . . on 4 jobs out of 5!

There's no magic about it! Just common sense! Over 400 pages of Ghirardi's 744-page RADIO TROUBLESHOOTER'S HANDBOOK contain tabulated and indexed listings of common trouble symptoms, their causes and remedies for almost every radio in use. Actually, it gives specific trouble listings for over 4800 home receivers, auto radio and record changer models of 202 manufacturers! Just look up a defective radio's make and model. The HANDBOOK tells exactly what the trouble is likely to be—exactly how to fix it. 4 out of 5 jobs can be handled by this method—in 1/2 the usual time BECAUSE TEDIOUS TESTING IS ELIMINATED. Over 300 more pages contain service hints, alignment data, tube information, graphs, diagrams and charts to help you fix ANY RADIO EVER MADE in far less time and at greater profit! Only \$5 complete (\$5.50 foreign). 5-DAY MONEY-BACK GUARANTEE.

. . . NO PREVIOUS EXPERIENCE NEEDED!

### COMPLETE BASIC RADIO-ELECTRONICS . . . for beginners

Sales records prove that more Radio-Electronic beginners have gotten their start from Ghirardi's 972-page RADIO PHYSICS COURSE than from any other book or course ever published. It's a complete radio course in book form—so head and shoulders above anything else that it is used as the basic text by thousands of students and by schools in 82 different countries of the world! Everything is explained as simply as A-B-C. Over 300 pages are devoted to Basic Electricity alone. 508 illustrations help you learn fast. \$5 (\$5.50 foreign).

**GUARANTEED**  
**TO HELP YOU LEARN**  
**COMPLETE BASIC**  
**RADIO-ELECTRONICS.**  
**. . . for beginners!**



Let Ghirardi's TROUBLESHOOTER'S HANDBOOK save you time on common radio service jobs! Let his MODERN RADIO SERVICING train you for complete, professional electronic work. Get BOTH BIG BOOKS at special price of only \$9.50 for the two. See coupon.

### MAIL ORDER rush coupon!

DEPT. RC-28, MURRAY HILL BOOKS, INC.  
232 Madison Ave., New York 16, N. Y.

- Enclosed find \$..... for books checked; or  send C.O.D. (no foreign C.O.D.'s) for this amount plus postage. It is understood I may return books for refund within 5 days if not fully satisfied.
- RADIO TROUBLESHOOTER'S HANDBOOK \$5 (\$5.50 foreign)       MODERN RADIO SERVICING \$5 (\$5.50 foreign)
- MONEY-SAVING COMBINATION OFFER: Both of the above big books, only \$9.50 for the two (\$10.50 foreign).
- RADIO PHYSICS COURSE \$5 (\$5.50 foreign).

Name .....

Address .....

City & Zone.....State.....

# TWO GREAT **OLSON** MONEY-SAVERS

## OHM CHEST CAP CHEST

**with 100 Insulated Resistors**  
This handsome Chest has 20 compartments, 10 in the base and 10 in a removable tray. Walnut finish; brass hinges and fastener. Contains 100 resistors stamped with resistance values, 5 ohms to 20 megohms, 1/2 watt to 2 watts, color coded. Every size is popular!



**\$4.95**

COMPLETE

Send for our FREE MONTHLY BARGAIN BULLETIN



Free with each Ohm Chest ordered, you get our "Resist-O-Guide" free. Revolving wheels in color show all resistance values.

**OLSON**  
RADIO WAREHOUSE Inc.  
73 E. MILL ST.  
Dept. 116  
AKRON, OHIO

**with 27 "Akrad" Condensers**  
A terrific buy! We want you to try the amazing new Olson "Akrad" Condensers, so we pack 27 "Akrads" (a \$31.45 List Value) in a beautiful walnut-finish wood chest with hinged lid and 6 compartments—and send you the whole works for only \$9.95. Wow! Order now!

**CONTENTS:**

QUAN.	CAP.	VOLTAGE	LIST	TOTAL
2	10	25	\$0.75	\$1.50
2	25	25	.85	1.70
5	20	150	.95	4.75
5	40	150	1.10	5.50
4	20-20	150	1.30	5.20
5	8	450	.95	4.75
4	16	450	1.35	5.40
Walnut Finished Chest				2.65
				<b>TOTAL \$31.45</b>

**\$9.95** COMPLETE

**GUARANTEE**  
Use 5 Olson "Akrads." If for any reason you are not satisfied, you can return the rest with Cap Chest and get back the \$9.95 and postage.

CLIP THE COUPON AND MAIL TODAY!

Send me \_\_\_\_\_ Ohm Chests with 100 Insulated Resistors in each, at \$4.95.

Send me \_\_\_\_\_ Cap Chests with 27 "Akrad" Condensers in each, at \$9.95.

I enclose \$ \_\_\_\_\_  Send my order C.O.D. Olson pays the postage. I will pay the postage.

NAME \_\_\_\_\_ (Please Print)

ADDRESS \_\_\_\_\_ (Please Print)

CITY \_\_\_\_\_ STATE \_\_\_\_\_

### 1-10 METER RECEIVER

(Continued from page 63)

meters, the most interesting transmissions will probably be the amateurs and the FM broadcasts. This is especially true of the 10-11-meter ham bands which are consistently hot. Long-distance signals are heard much of the time on these bands, even with a short, simple antenna.

C.w. signals may often be heard. To receive them, back down the regeneration control until the superregeneration hiss just disappears. For loudest volume reduce this control still further until the detector is just above the point of oscillation. The control may cause a slight change in tuning so both may have to be adjusted. For weak phone stations, superregeneration must be used. The hiss will die down as a station is tuned in. The stronger phone stations come in better on a non-oscillating detector with plenty of regeneration.

More than a dozen stations can be heard at this location (Brooklyn) on the new 88-108-mc FM band. Although this is essentially a local band, one FM station picked up here is located at White Plains, 30 miles away. Others in New Jersey and Long Island are also heard regularly with a straight-wire antenna. These weaker stations are heard with a superregenerating detector.

Four or 5 of the local FM stations come in with very good signal strength. It is found that such loud stations are heard best with the detector in a non-oscillating condition. The regeneration control, however, should be turned up to just under the point of oscillation. The listener who is accustomed to AM broadcasts only will be pleasantly surprised at the clarity of speech and music and the wide dynamic range of the FM transmissions. Although this simple set cannot compete with more elaborate receivers using multi-tube amplifiers, discriminators, and cascade limiters, many of the FM stations heard have far better fidelity and tone than the local AM stations picked up on a superheterodyne.



**Over 80,000 Sold!**

**THE ONLY DATA BOOK IN THE RADIO FIELD**

**New Enlarged Edition Ready!**

"Reference Data for Radio Engineers" is not another handbook—rather, it is a valuable compilation of material gathered by IT&T engineers throughout the world for the solution of everyday communication problems. Brings to the engineer and advanced amateur a storehouse of factual data.

Sold in bookstores, coast-to-coast. Greatly enlarged 2nd Edition has 336 pages, 400 graphs and tables. Hailed by educators and communications authorities.

New edition in durable green fabrikoid binding, \$2.00. Or take advantage of low quantity price for 12 or more to single address (\$1.60 each).

## REFERENCE DATA for RADIO ENGINEERS

IT&T Publication Dept. A-19, 67 Broad St., New York 4, N. Y.  
If not yet in your bookstore, order with this coupon

Reference Data for Radio Engineers  
IT&T Publication Dept. A-19  
67 Broad St., New York 4, N. Y.

I enclose \_\_\_\_\_ dollars, for which send me \_\_\_\_\_ copies, at \$2.00 per copy. (\$1.60 for 12 or more to one address)

NAME \_\_\_\_\_

ADDRESS \_\_\_\_\_

CITY \_\_\_\_\_ ZONE \_\_\_\_\_ STATE \_\_\_\_\_

DEALER'S ADDRESS \_\_\_\_\_

Special Discounts to Bookstores

### COIL DATA

All coils wound with No. 22 enameled wire—detector secondaries are center-tapped—

	Band 1		26-34 mc.	
	L <sub>1</sub>	L <sub>2</sub>	L <sub>3</sub>	L <sub>4</sub>
turns	6 1/2	3	7 1/2	3
height	3/8	1/8	3/8	1/8
	Band 2		42-56 mc.	
	L <sub>1</sub>	L <sub>2</sub>	L <sub>3</sub>	L <sub>4</sub>
turns	3	2	4	2
height	1/4	1/16	1/4	1/16
	Band 3		85-110 mc.	
	L <sub>1</sub>	L <sub>2</sub>	L <sub>3</sub>	L <sub>4</sub>
turns	4*	2	3*	2
height	5/16	1/16	1/4	1/16
	Band 4		120-150 mc.	
	L <sub>1</sub>	L <sub>2</sub>	L <sub>3</sub>	L <sub>4</sub>
turns	3*	1 1/2	2*	1
height	1/4	1/16	3/16	1/16

\* 1/4-inch diameter coils placed within coil forms—all others are wound outside the 3/4-inch forms.

## BC-946 as B.C. RECEIVER

(Continued from page 26)

delay is about 0.5 second for the good bass response of this set. Both diode plates are used to avoid loading the last i.f. transformer and to keep the impedance-to-load-resistance ratio low. One of these plates is for the separate a.v.c. system and has a small voltage delay from the cathode bias of the first audio amplifier. The diode which was originally grounded is used for the a.v.c., with two 3-megohm resistors and a .0001- $\mu$ f condenser, as shown in the schematic. The condenser was salvaged from beat-frequency oscillator components. The a.v.c. kicks in at the right point and will hold all but the most rapidly fading stations at a constant level. The cathode resistor causes the grids of the tubes operated by the a.v.c. to have a lower resistance to ground.

It might be well to note that all the 115-v a.c. lines run down one side of the chassis, and the audio line to the volume control down the other. To reduce electrostatic hum pickup, the heaters of the tubes are nearer ground potential as they are nearer the front end of the set.

The i.f. selectivity may be broadened for better high-frequency audio response. After aligning the trimmers for maximum signal, each one may be turned a little out of alignment, turning the first to the right, the second to the left, and so on. This will of course increase interference from adjacent channels and lessen the sensitivity.

You are faced with a dilemma in the alignment of the set. You can either tune the entire broadcast band, and as a result have the low-frequency calibration off by 20 kc, or lose the range from about 1530 up. If you prefer to have the entire broadcast band and lack a signal generator, set the main tuning condenser for its highest frequency point and adjust the oscillator trimmer C4e until you get the end of the broadcast band or the beginning of the police band. It may be advisable to do this at night if there are no near-by stations at the extreme high end. Then the mixer trimmer and the antenna trimmer are adjusted for maximum output. Now comes the dirty work. Remove the tuning indicator dial and file off the little key on the shaft. Tune the set to a known station at about 1500 kc or just below and move the dial about 3 degrees past the original pin and lock it to that station's correct frequency.

Set the oscillator padder for minimum capacitance. This will cause the set to be calibrated for the high frequencies and will read higher than the true frequency for the low end. If you are partial to the low end of the band, lock the dial nut with the dial set properly at a low-frequency station.

Don't be alarmed if the performance of this set is better than that commercial communications set you paid \$70 for.

# ESPEY

## The Custom Built Chassis



Notice those lines! That compact—well-proportioned—design!

Really a beaut!

Yessir! In producing the ESPEY Custom-Built Chassis we have kept in mind the need for full, well-rounded design, moulded to meet the needs of a discriminating market. The Model 7-B is only one of the quality line of custom-built receiver chassis produced by ESPEY. It is carefully engineered and manufactured to give absolute satisfaction in any type of installation.

The 7-B is an AM/FM superheterodyne receiver with 11 tubes including a rectifier tube, operating on 105/125 volts AC, 50/60 cycle. Wired for phono operation, this superbly engineered receiver is supplied ready to operate with 10" PM speaker with Alnico No 5 magnet, antennas and all necessary hardware.

For further details about this and the rest of the ESPEY line, write to Dept. C today

**ESPEY** MANUFACTURING COMPANY, INC.

528 EAST 72<sup>ND</sup> STREET-NEW YORK 21, N. Y.

Rear view of set. The i.f. transformers and coils under the chassis are all plug-in, and may be removed after holding screws at corners are taken out. Several methods of mounting the power pack may be adopted, from mounting it on rear of the chassis to making a separate pack and plugging into Jack 2.

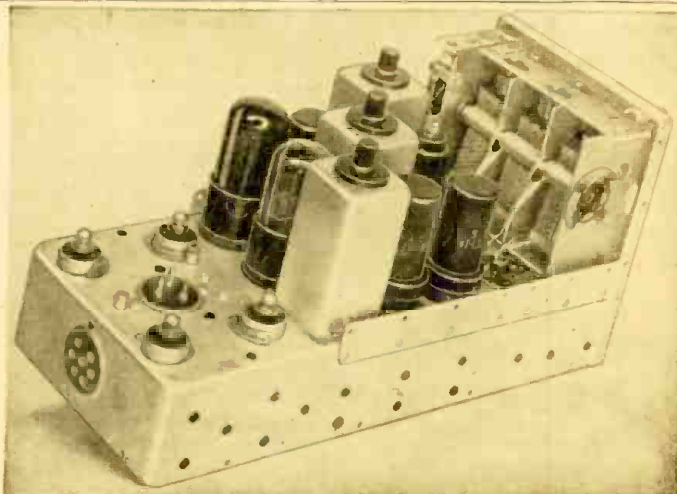

# SMASH Values from MID-AMERICA

Look at these sensational buys in brand-new, unused, top-quality radio parts and electronic equipment. You've never seen big buys like these before! And that's only the beginning. These values are but a few of the hundreds and hundreds of items Mid-America has in stock right now. Write for free catalog. You'll save money!

## New Standard Brand TUBES at World's Lowest Prices!

1A5GT.....47c	12AT6.....47c	9002.....41c
1H5GT.....47c	12C8.....49c	9003.....31c
1N5GT.....59c	12SA7GT.....47c	9006.....41c
1R5.....59c	12SG7.....49c	1E36.....19c
2A2/879.....39c	12SK7.....47c	1H20.....19c
3A4.....72c	12SO7.....52c	1E36.....49c
30SGT.....69c	12S07GT.....47c	3BP1.....\$1.00
5Y3GT.....43c	12SR7.....69c	5CP1.....\$1.75
6AG5.....69c	28D7.....79c	3D21A.....\$1.00
6H6.....49c	35L6GT.....47c	15E.....\$1.95
6J6.....59c	35W4.....45c	15R.....\$1.95
6SA7.....47c	50A5.....65c	RK34/2C34.....79c
6SA7GT.....47c	50B5.....47c	HY114B.....79c
6SH7.....34c	117Z3.....79c	HY615.....79c
6SK7GT.....47c	95A.....39c	801A.....99c
6S07.....45c	95S.....80c	803.....\$3.75
6V6GT/G.....47c	1613.....25c	807.....90c
6X5GT.....47c	1619.....13c	830B.....\$1.95
7C4.....59c	1624.....25c	1005.....49c
7E5.....59c	1625.....25c	1960.....\$1.00
7Y4.....59c	1632.....25c	VR90.....79c
7Z4.....59c	1633.....25c	VR150.....79c



### DACO Tube Tester

Tests performance, leakage and shorts in ALL receiving tubes, even sub-miniature and acorn. PLUS provision for tubes that may be invented. Durable construction is fully shielded; dust-proof case, high-visibility meter. Illuminated chart; no books or charts to be misplaced. Simple, fast operation with positive contact slide-switches; tests EVERY tube element. 110 volt A.C. 16 1/2" x 14 1/2". MA-2193. **\$2950**

### PORTABLE DACO TUBE TESTER

Same construction and operating features as counter model. Enclosed in sturdy case with durable black leatherette covering. 12 1/2" x 12 1/2". MA-2194. **\$3250**



### PHONO AMP and RECORD CHANGER

Inexpensive phono amplifier and record changer with "big set" features. Positive-action Crescent changer handles 10" and 12" records without jamming; finger-tip reject button. Lightweight and lifetime floating sapphire needle. 78 RPM constant-speed motor. 5" PM speaker and high-quality amplifier complete with tubes. Base measures 15 1/2" x 12 1/2" x 6". MA21. **\$2395**  
Base with motor, turntable and record changer. MA-2192. **\$1495**



### 15" HIGH-FIDELITY DYNAMIC SPEAKER

Husky 25-watt dynamic speaker for use where perfect reproduction is desired. Ideal for both indoor and outdoor installations. 12,500 ohm field. 16 ohm voice coil. Regular \$40.00. **\$1895**  
list. MA-2190.



### FM and HAM ANTENNA

AN-104-B. K-wave at 100-156 MC; formerly used with SCR-522, 274-N, ARC-5. A pair make an excellent broad-band dipole for FM reception. Coaxial connector in base. Very sturdy; use anywhere. MA-2153. **\$39c**

## FREE CATALOG

Order now—right from this ad! Send 25% deposit—we ship C.O.D. for balance plus postage. Write, too, for Mid-America's big, complete catalog that lists hundreds and hundreds of hard-to-get items—ALL AT UNBEATABLE LOW PRICES! Mail orders and catalog requests to store address—Dept. RC-28.

### MID-AMERICA CO. Inc.

STORE: 2412 S. MICHIGAN AVE. CHICAGO 16, ILL.  
WAREHOUSE: 2307 S. ARCHER AVE. CHICAGO 16, ILL.

# New Radio-Electronic Patents

By I. QUEEN

## ELECTROSTATIC PICKUP

Charles M. Sinnett, Westmont, N. J.  
(Assigned to Radio Corp. of America)  
Patent No. 2,423,208

An electrostatic pickup patent has been issued to an inventor who has already done considerable work in this field. The present invention is an improvement over previous types of electrostatic phonograph pickups.

As shown in the figure, the needle itself forms the variable capacitance. It is made of 2 conducting portions separated by a dielectric. One

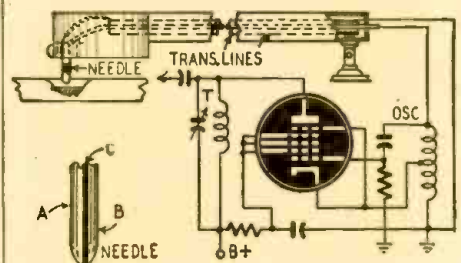

portion is very thin and therefore can vibrate much more freely than the other. As the needle follows a modulated record groove the audio vibrations cause the dielectric to be compressed and released alternately at the same audio rate. This varies the capacitance between the 2 conducting portions of the needle which are connected across an oscillator tank circuit (by transmission lines through the pickup arm.)

The varying capacitance causes frequency modulation of the r.f. oscillations. The output circuit T is slightly mistuned so that the midpoint of its resonance curve slope corresponds to the unmodulated r.f. oscillation. As the latter is raised and lowered (by the needle vibrations) the output amplitude also varies. This amplitude-modulated r.f. can be detected, amplified, and reproduced as usual.

One form of special needle is shown in the enlarged illustration. Dimensions may be approximately as follows:

- A .012 inch
- B .005 inch
- C .003 inch

The conductive portions may be of some very hard alloy such as steel or tungsten. The dielectric may be made of rubber or mica, or other suitable material.

## REACTANCE TUBE

Murray G. Crosby, Riverhead, N. Y.  
(Assigned to Radio Corp. of America)  
Patent No. 2,422,082

Oscillator frequencies are conveniently controlled by reactance tubes. This patent describes a simplified a.f.c. receiver.

The basic principle is simple. The oscillator tank is shunted by a reactance in series with a variable resistance. As the latter is decreased, the reactance has a greater effect in changing the frequency. The actual circuit uses a triode tube whose input is connected in series with C, the reactance. Coil L is a choke which merely completes the grid-to-ground circuit while maintaining the r.f. circuit through the triode's internal resistance.

The plate of the triode is supplied by the d.c. output of a discriminator-rectifier. As this

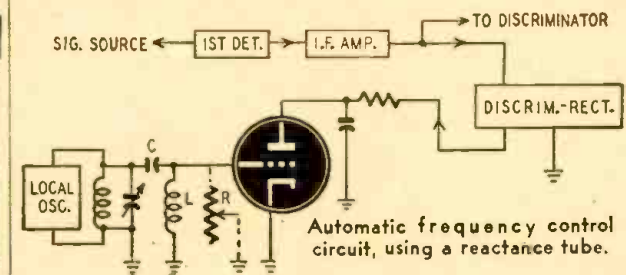

Automatic frequency control circuit, using a reactance tube.

voltage becomes lower, the tube input resistance becomes greater. The frequency of the local oscillator then becomes more nearly that value which is determined by the tank itself. As the plate voltage rises, the tube input resistance (shown dotted) becomes lower. C is then practically in parallel with the tank and causes the frequency to drop. This control can be used to retune a receiver which is slightly off resonance.

## MINIMUM VOLTAGE MEASUREMENT

John R. Boykin, Baltimore, Md.  
(Assigned to Westinghouse Elec. Corp.)  
Patent No. 2,425,987

Vacuum-tube voltmeters are usually peak-reading instruments calibrated in terms of r.m.s. Their deflection is proportional to the peak of a unidirectional, fluctuating voltage applied during any short interval. Sometimes it is necessary to know the minimum value of a fluctuating voltage. The circuit described here can be used for this purpose.

A rectifier is used with a condenser input R-C filter. This type of filter causes the condenser voltage to rise to the peak applied value when the rectifier resistance is negligible. In this circuit R and M have resistances much larger than the resistance of the rectifier.

The voltage applied to the rectifier is composed of two parts: A, a known steady potential from a battery or regulated power supply, and B, the fluctuating voltage to be measured. They are connected with opposing polarity so that the input voltage is actually A minus B. It is clear that the meter will tend to deflect to the peak

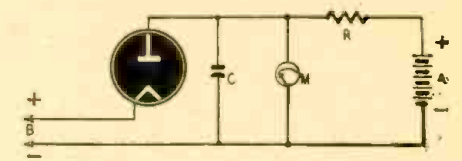

of A minus B. This occurs when B is a minimum.

To illustrate, consider an A voltage of 150, with B fluctuating between 20 and 50 volts. The meter will read the peak, 130 volts. If a 0-150 voltmeter is used (because A is 150), and if the calibrated scale is reversed (with zero at the left) the meter reads 150-130, or 20 volts, the minimum value of B.

In effect, the instrument is a peak-reading voltmeter which measures the peak difference between the two voltages.

If it is not convenient to use a reversed scale, the same measurement can still be made. In this case the result is calculated from A minus P, where P is the peak voltage indicated on the meter. The minimum or trough voltage will again be 150 minus 130, or 20 volts, the peak difference between the two voltages.

## SELENIUM OVERLOAD INDICATOR

George H. Shoemaker, Brooklyn, N. Y.  
Patent No. 2,384,200

Selenium rectifiers are widely used because of their long life when temperature limits are observed. It is difficult, however, to determine when the ratings are being exceeded.

To safeguard the rectifier, a simple thermocouple is used to measure the temperature. The couple is composed of constantan and copper wires twisted together and fused to the selenium where a small area has been left without an outer layer of alloy. A meter is connected to the thermocouple to indicate the temperature of the selenium, and indicate the danger point.

**DESIGNING TELEVISERS**  
(Continued from page 36)

ous voltages that frequently reduce gain are thus effectively eliminated.

Although essentially the video circuits are straightforward, excellent response is obtained by the use of low resistance in the detector circuits and a carefully designed series-shunt peaking arrangement in both the input and output of the section.

The audio signal is demodulated by slope detection, and ample volume is provided by the 2 stages of amplification that follow.

The salient feature of the synchronization separator is the exceedingly low voltages employed, a provision that affords maximum limiting.

Because of the latitude present in sweep design, it is always interesting to note what considerations guided final circuit decisions. The primary one, of course, is the selection of an impulse generator. Greater flexibility is possible in the vertical section because of its lower frequency, and consequently the advantages of a multivibrator can be utilized. The problem of stability, however, must be considered more cautiously in horizontal design. Initial plans tentatively called for another multivibrator in the horizontal section. Surprisingly enough, the only instability that actually materialized appeared to be intimately connected with interference, such as ignition disturbances. Investigation soon focused attention upon the long time constant of the capacity-grid-leak arrangement which originally coupled the differentiating network to the 6N7 multivibrator. At any rate, a direct connection from differentiator to grid, together with a further lowering of the differentiator time constant, reduced the problem to such negligible proportions that the multivibrator proved completely acceptable.

A common expedient used in the rectifier circuits to provide the kinescope with an extra 350 volts deserves a word of comment. Generally, the low side of the high-voltage rectifier is returned directly to ground. But since this procedure has the disadvantage of losing the potential available in the low-voltage section, it appeared sensible to connect the 2 rectifier circuits in series. As a precaution against noise pickup, the low side of the high-voltage supply was tied to a 350-volt terminal point safely distant from the r.f. unit.

Although simplicity in design was generally favored as preferable for kits, compromises inconsistent with a full exploitation of modern television techniques were studiously avoided. At the same time, the convenience of inexperienced constructors was borne in mind faithfully, and the resulting chassis layout is so commodious that people with no previous electronic experience whatever have succeeded in wiring the set. Moreover, they are spared the vexing inconvenience of depending helplessly upon the repairman to perform the minor rear chassis adjustments that sporadically confront all television re-

It's RADIONIC for PRICE • It's RADIONIC for VALUE • It's RADIONIC for DELIVERY

**FREE RADIONIC CATALOG**



It's a must for all

- Service Dealers
- Amateurs
- Experimenters
- Industrials
- Institutions
- Government Agencies

**TELEVISION "BOOSTER"**

**MILLEN "R9er"**



Use with any television set and improve signal strength 20 to 30 db. Enables good pictures in many "fringe areas". Small, compact and highly efficient accessory. Millen "R9er"..... **\$24.75**  
Coils (one required for each channel; specify channel.) Each..... **\$3.90**

CHANCELLOR RADIO • TELEVISION KITS AND COMPONENTS • RADIOS • TEST INSTRUMENTS • PARTS AND ACCESSORIES • INTER-COMMUNICATORS • DISC AND WIRE RECORDERS • PUBLIC ADDRESS • AMATEUR EQUIPMENT • TUBES • RECORD CHANGERS • TECHNICAL BOOKS • HARDWARE

**RADIONIC EQUIPMENT COMPANY**

170 NASSAU STREET, N. Y. 7

Tribune Theatre Entrance  
Telephone: WOrth 2-0421  
Cable "CHANSLOR"



**SAVE \$200\***  
OR MORE ON YOUR TELEVISION SET

TRANSVISION'S

**15" GIANT TUBE KIT**  
(120 Sq. In.)  
yours for only

**\$348.75**



**TRANSVISION**

NO EXTRAS

• **AT LOW COST** you now can have one of these huge screen TRANSVISION Television Receivers, preferred by engineers. Kit is complete from tubes to antenna. 20 hours of the most fascinating kind of work you've ever tackled gives you all the big sporting events, on-the-spot news, movies; ladies will see fashion shows, musical comedy, stage shows; the kids will be wild about the circus, rodeo, animated cartoons — and there are hundreds of other stupendous entertainment features available to the whole family. Suitable for large rooms.

• **ANYONE CAN BUILD IT.** Step-by-step crystal-clear instructions designed to make assembly easy. Top-flight performance guaranteed by manufacturer. Soldering iron and screw driver only tools needed. Absolutely no instruments or technical knowledge required. Simply follow directions. Thousands of people have assembled these superb TRANSVISION Receivers and now enjoy highest quality performance formerly available only in costliest factory-built sets.

**ORDER NOW FOR IMMEDIATE DELIVERY OR WRITE FOR FURTHER DETAILS**

(Terms: 10% deposit, balance C.O.D. We pay express charges if full payment is sent with order.)  
Fine walnut finished cabinets for above kits available at moderate cost.

**12" tube kit**  
as above  
**\$289.00**

**SPECIAL OFFER:** To see for yourself, you may order the instructions separately. Includes parts list, schematic diagrams, stage by stage drawings, etc. Send \$1.75, credit applied to your kit when ordered.

\*Based on average cost of receivers of comparable price and quality.

**WRITE FOR DEALER'S PRICES**

**MAIL TODAY!**

RADIONIC EQUIPMENT CO., DEPT. 102  
170 NASSAU STREET, NEW YORK 7, N. Y.

- Please send me your free catalogs, supplements and bargain lists as published — listing products of leading manufacturers of radio-electronic parts and equipment.
- Please send me Transvision instructions described above. I enclose \$1.75 which is returned to me if kit is ordered.

NAME.....  
P.O. BOX or STREET.....  
TOWN..... STATE.....

**BE YOUR OWN BOSS!**

**MAKE MORE MONEY**

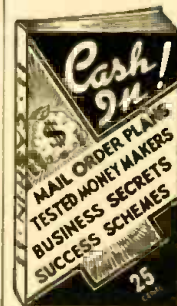

\$1.00 VALUE

**25c**

**40,000 WORDS IN TEXT**

**NO ADS ALL "MEAT"!**

In "CASH IN" you now get **THE** real money-makers — dozens of profitable tested mail order plans, confidential business secrets, dozens of practical tested formulas, successful test schemes — actual experiences of men who have started on a shoe-string — with less than \$10 capital. 25c — a copy postpaid. Send U. S. stamps, money order, or coin.

**Money Back Guarantee**

NATIONAL PLANS COMPANY

Box 26RA, Ansonia Station New York 23, N. Y.

of bakelite shafts attached to all controls with high-voltage connections.

# Get All 10

ONLY 50c EACH  
\$5.00 SET OF 10

## These Books Keep You On Your Toes!

Here are a total of 640 pages of downright practical knowledge to help you keep punching away at the unknown factors of radio until you have mastered them. Every one of the 10 is worth many times its 50c price if you will just apply a small portion of the information gained to your daily work. You'll be glad you have the complete set handy whenever you are trying to work out a particular problem in construction, testing or servicing. You'll like the easy-to-read type—the clean-cut printing—the smart, modern, flexible covers, and the great number of illustrations. They all help to make learning a pleasure. Order as many as you need today—better still, make it all 10.

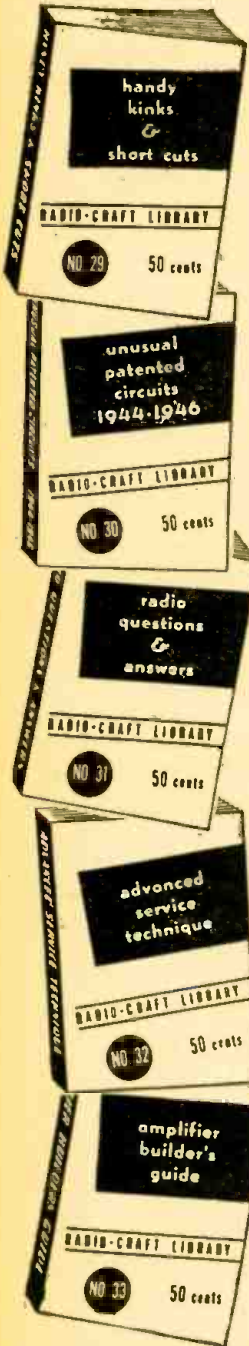

**No. 29—HANDY KINKS AND SHORT CUTS.** A carefully edited compilation of time savers. Kinks on Antennas—Power Supplies—Test Equipment—Servicing—In the Shop—Phonographs and Amplifiers—Coils and Transformers—Miscellaneous.

**No. 30—UNUSUAL PATENTED CIRCUITS, 1944-1946.** A gold mine in new book-ups! A selection of unusual circuits, many a result of wartime research—of great value to anyone interested in electronics. Control Circuits—Detectors and Amplifiers—Power Supplies—Miscellaneous Circuits—Foreign Circuits.

**No. 31—RADIO QUESTIONS AND ANSWERS.** Answers to most frequently asked questions. Clear schematics. Amplifiers—Receivers—Transmitters—Meters and Test Equipment—Interphones—Power Supplies—Phono Amplifiers—P. A. Systems.

**No. 32—ADVANCED SERVICE TECHNIQUE.** An up-to-date collection of information for the advanced serviceman: Visual Alignment—Tracking Problems—Negative Feedback—Tone Control Circuits—Adding Microphones to Sets—Matchless Loudspeakers—Remote Juke Boxes—Servicing Record Changers—Hum Elimination—FM Servicing.

**No. 33—AMPLIFIER BUILDER'S GUIDE.** Invaluable for the designer and builder of audio equipment. Tells how to build a wide variety of amplifiers. Detailed design information on: Push-Pull—Phase Inverter—Bass and Treble Boosters—Volume Expanders—Resistance Coupling—Internal Feedback.

**No. 34—RADIO-ELECTRONIC CIRCUITS.** An extensive collection of circuit diagrams, with brief, to-the-point descriptions of each, including: Intercommunications Systems—Power Supplies—Balancing circuits—V.T. Voltmeters—Amplifiers—Receivers—Phono Amplifiers—Short Wave Adaptors—Electronic Relays.

**No. 35—AMATEUR RADIO BUILDER'S GUIDE.** For the "ham" who builds his own. Practical, down-to-earth. Tells you how to Build: A 2 Meter Band Acorn Tube Set—Miniature Communications Receivers—Long Lines Transmitter—Beckler's Transmitter—Preselector—Rotary Beam Aerial—Power Supplies, etc.

**No. 36—RADIO TEST INSTRUMENTS.** A MUST for every radio man. This latest book on building test equipment places emphasis on practical construction of: Signal Tracers—Capacity Meters—Portable and Bench Multi-checker—Signal Generators—Tube Checkers—Electronic Voltmeters—and many others.

**No. 37—ELEMENTARY RADIO SERVICING.** For the radio man who knows little about servicing. How to get started, and even more important, how to keep going: Planning the Service Shop—Equipping the Shop—Systematic Circuit Checks—Signal Tracing Methods—Servicing the Midget—Soldering—Servicing Volume Controls—How to Service Speakers.

**No. 38—HOW TO BUILD RADIO RECEIVERS.** This book contains a sufficient variety of sets to appeal to every radio fan. Includes: Short-Wave, Broadcast, Portable, A.C. Operated, Miniature and Standard Receivers. Complete coil-winding data.

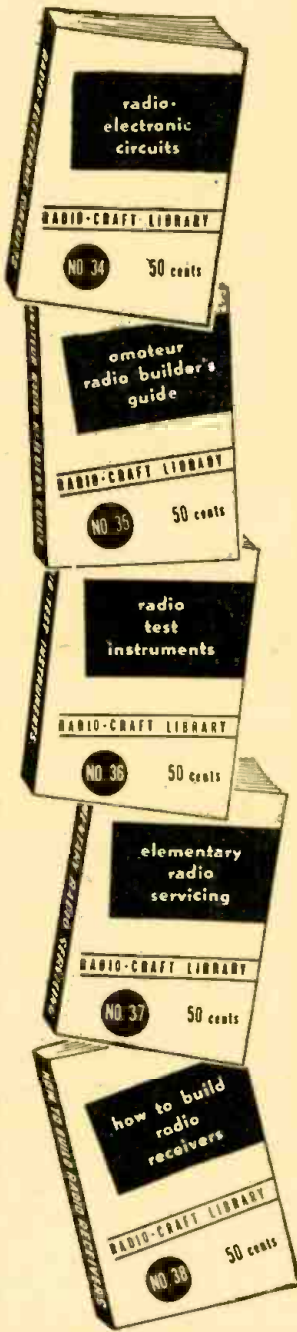

### WAR ON SERVICEMEN

(Continued from page 17)

radio technicians. Whether the repairmen will clean their own house or whether the city will have to do it, I don't know. But something should be done, and quickly.

This practice of planting a gimmick is decidedly unfair to the serviceman. While the short circuit may be "in plain view in back of the set," this in normal servicing procedure would naturally not be looked for and it probably would take even a very intelligent serviceman a long time to locate it for the simple reason that *it was not a natural inherent failure of the set but was a "plant"*.

Such "plants" are vicious, unfair, and certainly do not do much to the credit of the investigator's ingenuity. The fair way would be to take a set which has failed normally and have a serviceman ascertain the trouble. Then take this set to various servicemen and get an estimate.

There would at least be some fairness to such a procedure and it would make sense. "Planted" gimmicks on the other hand do not make sense, simply because they cannot be discovered quickly by routine testing—they are not expected.

Even when you take a set, which has failed in a natural manner, to two dozen different servicemen, the chances are that you may get 24 different prices. You can also shop around among 24 different dentists for a special inlay in one of your teeth and get a number of variable prices. This, is not an indictment either against the dentist or the servicemen. *In the end you always get what you pay for.*

There is the dentist who will beat every price in town and the same thing holds true of servicemen.

In a complex device such as a radio set where a good deal of labor and material go into repair work it would be a miracle if all prices came out uniform.

RADIO-CRAFT certainly does not hold any brief for the chiseling serviceman—of whom we are sorry to say there still exists a certain percentage in every locality. We stated so recently on this page\*. In that article it was pointed out that a small minority of servicemen, who abuse their calling, makes all the mischief. RADIO-CRAFT always has maintained that while this small minority gives radio servicing a black eye, the dishonest serviceman seldom stays long in business, because he can only live off perpetual new customers. But no matter where he is located, sooner or later, such a serviceman will be found out and will be eliminated.

All in all, despite many detractors, the servicing industry on the whole IS sound. For convincing proof we refer investigators and doubters to a comprehensive article which appeared, with facts and figures, in our August, 1946, issue, entitled: "Servicemen are honest."

\*Should Servicemen be Licensed?, December, 1947, issue.

## RADIO-CRAFT LIBRARY SERIES

RAD-CRAFT PUBLICATIONS, Dept. 28  
25 West Broadway, New York 7, N. Y.

See Your Radio Dealer  
If He Can't Supply You, Use Coupon

Send me the volumes (50c each, postpaid) checked. My radio dealer is unable to supply.  All 10 Books \$5.00

I enclose \$.....  29  34

Your Name .....  30  35  
(Print Clearly)

Address .....  31  36

Dealer's Name .....  32  37

Address .....  33  38

## Radio Thirty-Five Years Ago

In Gernsback Publications

**HUGO GERNSBACK**

Founder

Modern Electrics .....	1908
Electrical Experimenter .....	1913
Radio News .....	1919
Science & Invention .....	1920
Radio-Craft .....	1929
Short-Wave Craft .....	1930
Wireless Association of America .....	1908

Some of the larger libraries in the country still have copies of **ELECTRICAL EXPERIMENTER** on file for interested readers.

From the February, 1914, issue **ELECTRICAL EXPERIMENTER**:

The Radioson Detector, by *H. Gernsback*

An Efficient Transmitting Loose Coupler

An Extra Large Amateur Aerial  
The Goldschmidt Radio Tower at Tuckerton

A Novel Oscillation Transformer  
Increasing Your Transmitting Power  
An Efficient Loose Coupler, by *Eugene Dynner*

Wireless at Columbia University  
Radio Time Station  
Canadian Radio Law

## OPPORTUNITY AD-LETS

Advertisements in this section cost 25¢ a word for each insertion. Name, address and initials must be included at the above rate. Cash should accompany all classified advertisements unless placed by an accredited advertising agency. No advertisement for less than ten words accepted. Ten percent discount six issues, twenty percent for twelve issues. Objectionable or misleading advertisements not accepted. Advertisements for March, 1948, issue must reach us not later than January 24, 1948.  
Radio-Craft • 25 W. B'way • New York 7, N. Y.

**AMATEUR RADIO LICENSES. COMPLETE CODE** and theory preparation for passing amateur radio examinations. Home study and resident courses. American Radio Institute, 101 West 63rd Street, New York City. See our ad on page 86.

**MAGAZINES (BACK DATED)—FOREIGN, DOMESTIC.** arts, books, booklets, subscriptions, pin-ups, etc. Catalog 10¢ (refunded). Cicerone's, 863 First Ave., New York 17, N. Y.

**LANCASTER, ALLVINE & ROMMEL**, 436 BOWEN Building, Washington 5, D.C. Registered Patent Attorneys. Practice before United States Patent Office. Validity and Infringement Investigations and Opinions. Booklet and form "Evidence of Conception" forwarded upon request.

**PHONOGRAPH RECORDS 20¢. CATALOGUE.** Paramount, KN-313 East Market, Wilkes-Barre, Penna.

**6V DYNAMOTOR FROM 12V SURPLUS. NO REWINDING.** Full original output. Instructions. 50¢. Paul Hawkins, 1306 E. 27th, Kansas City, Mo.

**RADIOMEN, SERVICEMEN, BEGINNERS—MAKE** more money easily. \$250 weekly possible. We show you information free. Merit, 216-32L, 132nd Avenue, Springfield Gardens 13, New York, New York.

**TESTING EQUIPMENT. ALL TYPES AND MODELS.** Expertly repaired and calibrated. Free estimates. METROPOLITAN ELECTRONICS, 42 Warren St., N. Y. 7, N. Y.

**WRITE DEPT. RC 20 FOR OUR LATEST FREE BARGAIN** list of Radio and Electronic parts. R.C. Radio Parts and Dist. Co., 733 Central Ave., Kansas City 6, Kansas.

**YOU CAN ACCURATELY ALIGN SUPERHETERODYNE** receivers without signal generator. Complete instructions \$1. Moneyback guarantee. Chas. Gates, Pecos 2, Texas.

**RUBBER STAMPS, ETC. FOR SALE.** COOKSON, Box O-RC, Puxico, Missouri.

**WE REPAIR ALL TYPES OF ELECTRICAL INSTRUMENTS,** tube checkers and analyzers. Hazelton Instrument Co. (Electric Meter Laboratory), 140 Liberty Street, New York, N. Y. Telephone—Barclay 7-4239.

 Living Room Concerts	<i>More Economical</i>	 Airport & Train Announcements	<i>Cannot Tangle</i>	 Broadcast Station Monitoring
<i>Longer Playing Time</i>	<b>Now Available! 8 HOURS OF CONTINUOUS PLAY ON THE MAGNETAPE* RECORDER!</b>		<i>30 Second Rewind</i>	
 Industrial Factory Work Music	Now — record and play back on this amazing instrument any sound that can be heard, and many that cannot — from a concert hall symphony, to the beat of your heart. Simple interchangeable capstans provide a choice of three tape speeds for high fidelity, medium fidelity, or up to 8 hour voice recording. The ideal recorder and playback unit for home, office, industry, and broadcast station.		 Conference Recording	<i>Easy Editing</i>
<i>Quieter Operation</i>	Write today for our free illustrated technical catalog featuring our complete series of Magnetape Recorders and accessory equipment. Send 25¢ in stamps or coin for our new booklet, "Elements of Magnetic Tape Recording — and 999 Applications." * Trademark		 Copying Valuable Disc Records	 Recorded Lectures
 Passenger Entertainment	<i>Improved Response Range</i>	<i>Complete Automatic Erasing</i>	<b>AMPLIFIER CORP. of AMERICA</b>	

398-10 Broadway

New York 13, N. Y.



## Better Products for the Radio Industry

### Static Chaser Kit • Cement Inspection Mirror • Tube Puller

#### NEW G-C TUBE PULLER

Makes it easy to remove or insert miniature tubes. Simple to operate. Inserts or extracts tubes where fingers cannot—in hard-to-reach places. Saves time and money. Ends tube breakage. No. 5093 Miniature Puller



List \$1.50

#### NEW G-C INSPECTION MIRROR

Handy, inexpensive for radio men, servicemen and electricians. Ideal for inspecting parts that are hard to see. Every serviceman is a prospect. No. 5090



List 50¢

#### NEW G-C STATIC CHASER INJECTOR AND POWDER

Tire static powder kits improve auto radio reception. Eliminates wheel static interference. New powder is blown into all inner tubes, easy to use. For every car owner.



No. 5604—Injector for G-C Static Powder ..... List \$1.50

No. 5605—G-C Static Powder Packet for 5 tires ..... List \$1.00

No. 5606—Kit Powder Packet and Injector ..... List 2.50

#### G-C RADIO SERVICE CEMENT

Best cement for speaker and radio work. Suitable for cementing replacement cones. Flexible, vibration proof, water proof and fast drying. Will cement most anything. No. 30-2—2 oz. bottle with brush ..... List 50¢



Have you seen the new G-C "Speedex" Wire Strippers... write for illustrated literature.

RADIO DIVISION DEPT. D

G-C Products are available at leading distributors. Write for your copy of our new illustrated catalog.

## GENERAL CEMENT Mfg. Co., Rockford, Ill., U. S. A.

Manufacturers of over 3,000 products • Sales offices in principal cities



# STEADY PROFITS

**YOUR OWN BUSINESS with CORADIO**  
The Coin Operated Radio

Place these specially built radios that play 1 or 2 hours for 25c in the thousands of available hotel rooms, tourists courts, etc. They yield immediate profits and steady income. Install CORADIO, the finest made. Limited capital required. Send for further information. Write today.

**CORADIO** Coin Operated Radio  
308 W. 31 Street Dept. RC. New York 1, N. Y.

# S.S.S.

"Servicing by Signal Substitution"

Learn about this modern dynamic approach to radio servicing with ONLY BASIC TEST EQUIPMENT.  
... Fully described in a 120 page book available from your Precision Distributor or factory at 40c.  
... Schools are invited to inquire regarding quantity orders from our Educational Division.

**PRECISION**  
APPARATUS COMPANY INC.  
ELMHURST 4, N. Y.  
Manufacturers of Fine Test Equipment  
RADIO • TELEVISION • ELECTRICAL • LABORATORY

*this valuable book*  
**FREE** with your  
*Subscription*  
to **RADIO-CRAFT**



Now we can offer you, for the first time, the cream of articles on construction and servicing prepared by foreign technicians.

The 1948 RADIO-CRAFT REFERENCE ANNUAL brings this world-wide information, along with some of the best of our own country, in one volume. Just run your eyes down the contents listed on the right and see for yourself what a wealth of new and important material it contains. Each article has been selected with a view to presenting information not appearing elsewhere in textbooks, manuals, or periodicals printed in the United States. Each has accurate schematics and detailed data enabling you to get at constructional and operational features easily, and—if you so desire—to duplicate similar models.

Another feature of the Annual is the RADIO-CRAFT Index, covering issues between Oct. 1946 and Sept. 1947. This Index enables you to locate the important articles appearing during the year on such special subjects as come up in the course of your work or studies. Taking all in all - - the worldwide construction and servicing articles - - the handy kinks and short cuts, and the RADIO-CRAFT Index you have a well rounded reference book of inestimable value. Get this valuable 1948 reference book by subscribing to RADIO-CRAFT at once.

**CONTENTS**

- TRANSITRON OSCILLATOR—ITS USES
- MAKE A V.H.F. SUPERREGENERATOR
- CHECK YOUR FREQUENCY
- IDENTIFY THAT STATION
- CONSTRUCTING A B.F.O.
- TODAY'S D.-C. AUDIO AMP.
- METAL LOCATOR
- LOW-LEVEL TONE CONTROL
- PHOTO-PRINT TIMER
- SUPERSONIC DOOR OPENER
- POWER SUPPLY STABILIZER
- NEW CIRCUITS FOR OLD
- SIMPLE TUBE VOLTMETER
- 2-TUBE PORTABLE
- SIGNAL TRACER FROM OLD RECEIVER
- H.I-FI TRF TUNER
- 4-TUBE REFLEX SET
- LOUDSPEAKER FIDELITY
- PHONO AMPLIFIER WITH ADJUSTABLE FEEDBACK
- MULTI-CIRCUIT CLIP SET
- A. F. EQUALIZER STAGE DESIGN
- FM RECEIVER
- NOVEL CLASS A AND B AMPLIFIER
- V.O.M.-COND. TESTER
- RADIO-CRAFT INDEX OCT. 46-SEPT. 47

---MAIL COUPON WITH YOUR REMITTANCE TODAY---

RADIO-CRAFT  
25 West Broadway, Dept. R-C-2, New York 7, N. Y.

Gentlemen: Enter my subscription to RADIO-CRAFT for the period indicated below, and send me a free copy of the new 1948 RADIO-CRAFT REFERENCE ANNUAL. I enclose my remittance.

1 Year \$3.50       2 Years \$6.00       3 Years \$8.00  
 This is a new order       Renewal       Extension

Name ..... (Please print clearly) .....

Address .....

City ..... Zone ..... State .....

(Canadian, add 50c for each year; Foreign, 75c)

### SCRATCH SUPPRESSOR

Surface noise and scratch are constant bugaboos of high-quality phonograph reproduction. Filters, tone controls, and suppressors have been developed to combat this interference. In most instances, however, there must be some kind of compromise—either attenuating the signal in the scratch frequency range or reproducing the signal at a level where it overrides scratch. A new electronic scratch suppressor and volume expander combination, described in *Audio Engineering*, can be connected between a high-level pickup and the amplifier input circuit. It is basically an electronic tone control producing high-frequency attenuation when the high-frequency component of the signal is comparatively small.

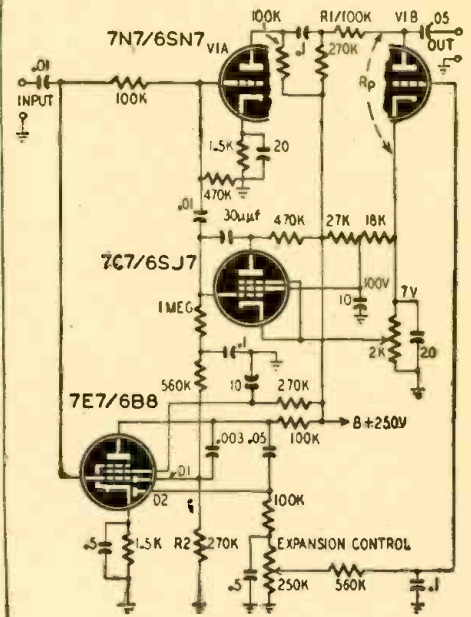

This 3-tube unit can be operated from the power supply of the average a.c. amplifier or from a separate supply.

The input signal is amplified by V1A and resistance-capacitance-coupled to the plate of V1B. This triode is connected so its internal plate resistance  $R_p$ , and the 100,000-ohm resistor R1 are in series across the output of V1A. The output voltage of the unit is proportional to the ratio of  $R_p/R_p + R1$ .

The 7C7 is connected to the grid of V1A so that it acts as a variable capacitance reactance shunting the input circuit. The effective capacitance of the tube is controlled by its effective grid bias. Operating bias is taken from a tap on the 2,000-ohm resistor in the cathode circuit of V1B.

A pentode amplifier 7E7 is connected to the input circuit. Its plate is connected to one of its diodes D1 through a .003-µf condenser that attenuates the lows and passes the highs to the diode. The diode load resistor R2 is in series with the grid leak of the 7C7 and a 560,000-ohm-resistor — 0.1-µf-condenser time delay network. When no highs are in the applied signal, the voltage developed across R2 biases the 7C7 so that its capacitance reactance is low, thus shunting high-frequency scratch and surface noise from the grid of V1A. When high notes come through, the bias



varies to increase the capacitance reactance, permitting the highs to be amplified.

The remaining diode of the 7E7 is coupled to the plate through a .05- $\mu$ f condenser. This diode is loaded by a 100,000-ohm resistor in series with a 250,000-ohm expansion control. The signal developed across the control is applied to the grid of V1B through a time-delay circuit (560,000-ohm resistor and 0.1- $\mu$ f condenser) that controls the attack time. The 0.5- $\mu$ f condenser across the control determines the release time. On loud passages, the bias is increased on V1B, increasing its plate resistance and making a greater signal available at the output terminals.

The position of the tap on the cathode resistor of V2B sets the operating point of the 7C7. Set this by turning the arm of the control to the ground end. Apply a 5,000-cycle, 0.3-volt signal to the input and measure the signal at the output terminals. Adjust this control to reduce the output 10 db.

### RADIO RECORD PLAYER

(Continued from page 27)

of its low interelectrode capacitances. The 6AB7/1853 is a very simple reactance-tube modulator. In the usual applications, these modulators work at fairly low frequencies, depending on doublers and triplers to reach the 88-108-mc band. In this unit the modulator acts directly at the output frequency. It has been stripped of all unnecessary parts so that it will not impair oscillator efficiency. As a result, there is a certain amount of AM, but it has no effect on reproduction. With a high-output crystal pickup connected to the input receptacle, almost a full 150-ke swing can be obtained from average records.

The power transformer, filter condensers, and rectifier are mounted at the left of the chassis in the usual manner. But the oscillator and modulator components are mounted above the chassis. This makes the unit easier to adjust and allows the coil to radiate freely. The oscillator and modulator tube sockets are mounted vertically on small angle brackets. The sockets and the oscillator tank are all within a 3½-inch-diameter circle so that long leads, which introduce large losses at these frequencies, are not necessary.

In constructing the oscillator, first assemble the power supply. The power transformer may be any one that can be found in the junk-box. Any full-wave rectifier tube will do. The filter condensers can be of any value between 12 and 40  $\mu$ f.

Next, the other 2 tubes and the tuning condenser should be mounted. The tuning condenser is a miniature air padder (Bud LC-2076) with all but 2 rotor and 2 stator plates removed. It has a screw driver tuning adjustment. It is mounted face down so that it can be tuned through a hole from under the chassis. Only sufficient room should be allowed between tube sockets and con-

(Continued on page 80)

# Over 300 TYPES Vacuum Sealed TRANSFORMERS

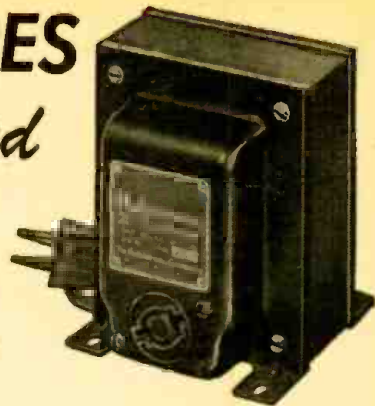

Step-down Transformer  
in S2 Mounting

- Adjustable mounts make your Service work easier.
- Sealing under Vacuum means 100% Protection.
- No skimping, to give you brilliant and lasting performance.

Halldorson offers a complete line of replacement and amateur transformers . . . all *vacuum sealed*. More than 300 different types including new high fidelity. See your parts jobber and select the type best suited for your needs. Get the best. Get Halldorson *Vacuum Sealed Transformers*:

For new catalog, write  
The Halldorson Co., 4500 Ravenswood Ave., Chicago, Ill.



## GOING IN FOR TELEVISION WORK?

Then you need a frequency-sweep signal generator to get a clear pattern on any set you build, service, or install. This unit will save its own cost in a very short time by eliminating time-wasting blundering and hit-miss methods of television alignment and checking.



### Specifications

- Tubes: 6C4-Osc #1, 6C4-Osc #2, 6AG5-Mixer, 6AG5-Cathode Follower, 5Y3-Rectifier
- Mean Frequency Range: 5-100mc, 170-216 mc (covers television and FM IF and Broadcast Frequencies)
- Sweep Width: Variable from 500 KC-10 mc
- Maximum Output: 1 Volt
- Output Impedance: 100, 10 ohms
- RF Probe for Point to Point check
- Electro-mechanical sweep mechanism
- Terminated coaxial output cable
- Furnished complete with tubes, probe and output cable and instruction booklet.

**\$68<sup>50</sup>**

## TELEVISION PICTURE TUBE

We have an exceptional buy in a 9-inch electromagnetic cathode ray tube. The MW22-2 is an exact replacement for the nine inch tubes used in GE Television Receivers. This tube may be used in practically any receiver designed for electromagnetic deflection.



- CHARACTERISTICS MW22-2
- Heater Volts—6.3
  - Heater Current—6 amps
  - Fluorescent Screen—White-Medium Persistence
  - Anode 2 volts—5000 Max.
  - Anode 1 volt—250 Max.

These are brand new GE types—at the unbelievable LOW price of

**\$13<sup>95</sup>**

★ **EDLIE ELECTRONIC, Inc.** ★  
135 LIBERTY STREET, NEW YORK, N. Y. Tel. BArlay 7-4763

## VERIFIED SPEAKERS

"They Glorify the Tone"

**WRIGHT  
Inc.**

2234 University Avenue

St. Paul 4, Minnesota

# All at 59¢ each

## RADIO TUBES—KNOWN BRANDS—BULK

43	1LN5	1H5	6F6	6Q7	25L6	6SA7	14B6
47	3Q4	6A7	6V6	6X5	35L6	6SQ7	14A7
0Z4	35Y4	6A8	6H6	7B7	50L6	50B5	117Z3

## KITS

FM, CONDENSER & COIL (88 to 108Mc), incl. Instructions ... \$4.95  
 5-TUBE SUPER-HET complete with tubes and bakelite cabinet 12.50  
 6-TUBE SUPER-HET complete with tubes and bakelite cabinet 13.95  
 INTER-COMMUNICATION complete with cabinets and 3 tubes 12.75

3 WAY-PORTABLE RADIO (Leatherette 9"x6"x4½") AC-DC, comp. with batteries ... \$19.90

PHONO MOTOR, complete with turntable	2.95
CRYSTAL PICK-UP ARM, including all hardware	1.75
OUTPUT TRANSFORMER (50L6)	.39
VOLUME CONTROLS, ½ or 1 Meg. with switches	.39
100—KNOBS—ASSORTED	4.95
100—SOCKETS—ASSORTED	4.95
100—CONDENSERS—ASSORTED—.001 to .02	3.95
100—RESISTORS—ASSORTED	1.50

**BROOKS RADIO DISTRIBUTING CORP.**  
 80 VESEY STREET (DEPT. A), NEW YORK 7, N. Y. (COrtlandt 7-2312)

## SUNSPOTS AND RADIO

(Continued from page 25)

ously interrupted. About a day after the greatest damage has been done to the F-layer, the lower E-layer is seriously damaged, causing interference in receiving radio programs on the broadcast band. After the disturbance on the sun is past, the upper, or F-layer is the first to recover. The lower, or E-layer may stay disturbed for several days, and broadcast reception may take a week or even more to return to its normal values after so extensive a catastrophe.

We must understand, of course, that all this applies to long-distance reception. It is only when one is concerned with radio waves coming from stations 100 to 1,000 miles distant that the sky waves of radio are utilized. If you live in the suburbs of New York, Chicago, or any other large city, you usually receive your favorite newscast, music, or entertainment program from one of the near-by stations. In this case sunspots may pass unnoticed, as it is the ground wave that passes directly from the broadcast station to your antenna that is responsible for your enjoyment of the program.

One must be careful not to generalize too widely or to say that under all circumstances sunspots make for poor radio reception and a clear sun makes for good reception. It all depends on the communication path involved, the length of the radio waves employed or their frequency, and whether or not you are beyond the radius of the ground wave when you tune in your program. It is in the case of long-distance radio, involving transcontinental and transoceanic communication, that distances are great enough to be concerned with sky-wave transmission. If we can anticipate the number of sunspots in any future year, we can estimate the best long-distance communication frequencies. It is for this reason that world-wide communication companies are so intimately concerned with cosmic effects on sky-wave propagation, conditions that are quite beyond man's control.

SUNSPOT NUMBERS 3 MONTH MOVING AVERAGES

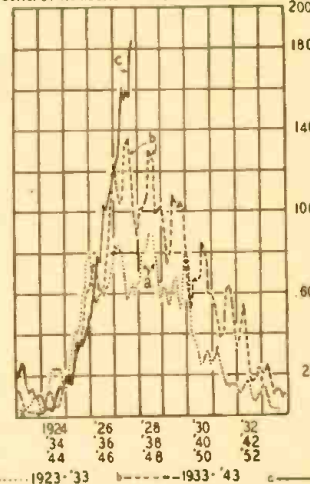

Fig. 7—Sunspot cycles of the last 3 decades.

## GOVERNMENT SURPLUS

If you cannot get to the Government Sales of War Surplus Radio Equipment, the next best thing to do is to buy our SPECIAL \$25.00 GOVERNMENT RADIO SURPLUS ASSORTMENT.

We buy large quantities of these items all over the country, divide those items we don't have in large quantities into choice assortments for which we know you would gladly pay \$25.00 if you could see them.

On a deposit of \$5.00 we will ship you COD (balance \$20.00) freight collect, a large quantity of Government Surplus Radio Items subject to your inspection. If, after inspection, you are not more than satisfied, return to us, freight charges collect and all it will have cost you will be freight charges one way. We will then refund your initial payment of \$5.00. You should be able to dispose of a few of the items that you may not need for the entire cost.

This is the cheapest way we can sell you War Surplus Radio Material. Our warehouses are filled with thousands of choice Government Surplus Radio Items. Lot of them we do not have in sufficient quantity to advertise nationally and the cost of inventorying, itemizing, corresponding, etc., would only increase their cost to you; therefore we make this offer. If you wish to mention a few items you desire, we will endeavor to include them in the assortment.

**THE ABELL DISTRIBUTING CO.**  
 7 E. Biddle Street, Baltimore 2, Maryland

## GIANT PENNY SALE

PAY 1¢ MORE — GET 2

Over \$150,000 worth of merchandise set aside for this special sale. Stock up now for the entire year. Save yourself \$\$\$\$\$.

### ALL ITEMS GUARANTEED

For example, a High Voltage Western Electric Transformer, input 115V, 60c-output 1200 V @ 12ma, 2½" x 3½" x 5½" and weighing 5 lbs., sells for \$2.25. YOU GET 2 for \$2.26.

Filter Chokes, Resistors, Ceramic Sockets, High Voltage Transformers, Relays, Selenium Rectifiers, Westinghouse Meters, Connectors, Rheostats, Condensers, Tubes and hundreds of other parts.

WRITE FOR SPECIAL 1¢ SALE CATALOG—FOR THE BUYS OF A LIFETIME!

Sale Runs through March 30.

**Universal general corp.**  
 365 Canal St., Dept. C-R, New York 13, N. Y.

SERVICE WITH A STAR

New LOW price... same HIGH quality

## THE STAR TESTER

VOLT—OHM—MILLIAMMETER

\$24<sup>25</sup>



An all-around tester with high quality features at an amazingly low price. Built for versatility and handiness. Gives you easy, accurate reading, with a 4½" 400 microampere meter. Case is metal, crackle finished. Comes complete with batteries, test leads, and instructions for use.

### DESIGN DATA

- 5—DC VOLTAGE RANGES—0 to 1000 volts
- 5—AC VOLTAGE RANGES—0 to 1000 volts
- 5—OUTPUT METER RANGES—0 to 1000 volts
- 4—DC CURRENT RANGES—0 to 1000 ma.
- 3—RESISTANCE RANGES—0 to 5 megohms
- DECIBEL RANGES — -10 to -54

You are using the best when you "Service with a STAR." Contact your dealer today or write us direct.

Literature available on all STAR Products. Write for your copies today!

**STAR MEASUREMENTS CO.**

442 East 166th St., Dept. C-2, New York 56, N. Y.

## ANOTHER New BROWNING DEVICE

### FM TUNER Model RV-10

Small, compact, easily mounted high fidelity FM tuner. Armstrong FM circuit. Range: from 88 to 108 MC.

Frequency meters. WWV standard frequency calibrator. Oscilloscope. Power supply and square wave modulator. Capacitance Relay. FM-AM Tuners. FM Tuner.

KNOW THE ENTIRE BROWNING LINE. ENGINEERED FOR ENGINEERS

Write Dept. J for Catalog



**BROWNING**

LABORATORIES, INC.  
 WINCHESTER, MASS.

# BIG MONEY IN RADIO SEE THESE BRAND NEW RADIO BOOKS FREE

## COYNE'S New 5 Volume Set "APPLIED PRACTICAL RADIO"



You men who want to go places in Radio, and who know how much a solid working knowledge of the field helps to get the big money—this is IT! Over 1500 pages of down-to-earth Radio, from simplest principles to newest Television! It's all there easy to understand—how and why it works . . . how to construct, install, service. PA, short-wave, auto-radio, aviation, radio-phonographs, FM, testing instruments and trouble-shooting short-cuts, phototubes — you name it, COYNE'S got it, in "Applied Practical Radio"!

**SEE IT FREE FOR 7 DAYS**

**JUST OFF THE PRESS!**

**PRACTICAL! CLEAR! COMPLETE!**

5 big volumes—1000 illustrations and diagrams, with step-by-step photographs which "break down" the equipment for you to show what makes it "tick". Up-to-the-minute, complete, easy to follow . . . written as only COYNE books are written!

**GET THIS BOOK FREE for LOOKING AT SET**



**Brand New! Explains circuits of latest sets.**

**VALUABLE BOOK FREE for Looking at 5-Volume Set**

**Send This Coupon NOW**

You must SEE these books to know how easy it is to prepare for the big jobs in radio. Here's our special offer:—we'll send the complete 5-volume set for your 7-Day FREE Examination. And with it, we'll include our valuable, new guide for all radiomen, "150 New Radio Diagrams Explained," absolutely FREE! If you keep the 5-volume Set all you pay is \$3.00 within 7 days after the books arrive and \$3.00 per month until \$16.75 is paid—or you can pay \$15.00 cash price. If you don't want the set, return it and you OWE NOTHING. But either way you keep the "150 Radio Diagrams Book" as a gift. That book is ABSOLUTELY FREE.

EDUCATIONAL BOOK PUBLISHING DIVISION  
COYNE ELECTRICAL & RADIO SCHOOL  
DEPT. 28-T1, 500 S. Paulina St., Chicago 12, Ill.

O.K., send me, postpaid, your new 5-volume set, "Applied Practical Radio" on 7 Days' Free Trial per your offer in Radio-Craft. Be sure to include as a gift the book of 150 New Radio Diagrams Explained, absolutely FREE.

**SEND NO MONEY** REMEMBER—COUPON IS NOT AN ORDER, just a request to see set free and get the FREE BOOK. But offer is limited, so act at once!

NAME ..... AGE .....

ADDRESS .....

TOWN ..... ZONE ..... STATE .....

**COYNE ELECTRICAL & RADIO SCHOOL (Founded 1899)**  
500 S. Paulina St. Dept. 28-T1 Chicago 12, Ill.

### A TWO-BAND PORTABLE

This 2-band portable receiver is handy for vacation trips or as a stand-by set for a shortwave listener. It is a 4-tuber with 6-tube performance, using a pair of standard 2-band tuning coils to cover the broadcast and 5.8- to 19-mc bands.

The band-change switch is a 6-pole, 2-position, nonshorting rotary unit. Two of its sections ground the a.v.c. system when the set is tuned to the short-wave band. A 1T4 is used as a local oscillator with the 1R5 connected as a mixer. It is unusual to find a separate oscillator in a set of this size. I find that it works better on short waves, particularly when the B-supply is limited to 45 volts.

The 1T4 i.f. amplifier is standard and uses iron-core input and output trans-

formers. The balance of the circuit is designed around a 1D8, diode-triode—power-amplifier pentode. The diode section is the second detector and a.v.c. rectifier. The triode section is a voltage amplifier shunt-fed transformer-coupled to the power amplifier section. A small 3:1 interstage transformer is used. The shunt-fed triode plate circuit seems to give better quality. Bias for the power amplifier is from the voltage drop across the 450-ohm resistor between the B-minus lead and the chassis.

**JAMES CHARLES SOUKUP,**  
Chicago, Ill.

(This set may be converted to a portable amateur receiver by using 3-band coils for continuous coverage between 540 kc and 18 mc.—Editor)

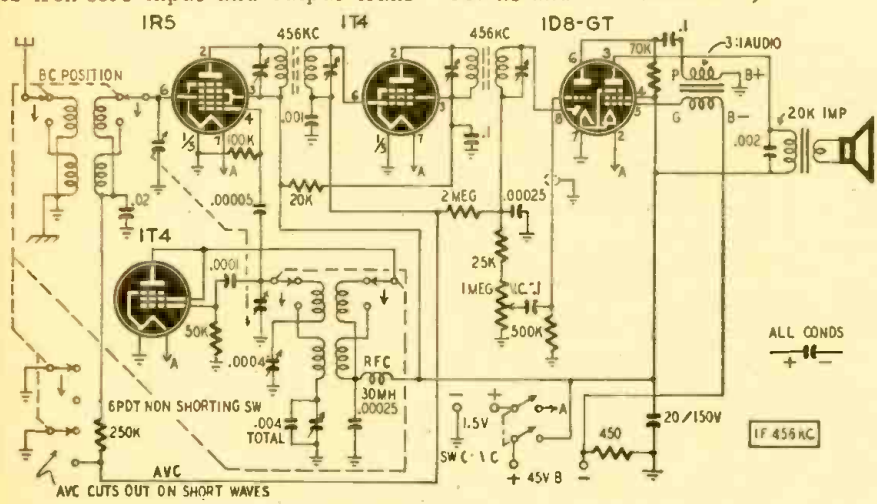

### Get Started in Radio



**10 "HOW-TO-DO-IT" BOOKS**  
Get a solid foundation in radio by means of these 10c timely text books. Each clearly written, profusely illustrated, contains over 15,000 words. You'll be amazed at the wealth of information packed into these handy books. Excellent for reference—ideal for technical library. Your money back if not satisfied.

**5 BOOKS for 50c**  
**10 BOOKS for \$1.00**

- Sent to You Postpaid**
- No. 1—How To Make Four Doerle Short Wave Sets
  - No. 2—How To Make The Most Popular All-Wave 1 and 2 Tube Receivers
  - No. 3—Alternating Current for Beginners
  - No. 4—All About Aerials
  - No. 5—Beginners' Radio Dictionary
  - No. 6—How To Work With Radio
  - No. 7—How To Read Radio Diagrams
  - No. 8—Radio for Beginners
  - No. 9—Simple Electrical Experiments
  - No. 10—Television

Remit by check or money order—register letter if you send cash or stamps.  
**RADIO PUBLICATIONS**  
25A West B'way, New York (7)

**PEN-OSCIL-LITE**  
Extremely convenient test oscillator for all radio servicing; alignment • Small as a Pen • Self powered • Range from 700 cycles audio to over 600 megacycles u.h.f. • Output from zero to 125 v. • Low in cost • Used by Signal Corps • Write for information.  
**GENERAL TEST EQUIPMENT**  
38 Argyle Ave. Buffalo 9, N. Y.

**\$25.00 Value for Only \$1.89**  
8000 ohm Dual, Hearset H-16/U—most sensitive phones built—noiseproof—may be used as a sound powered intercom—Also used with simple Xtal to make a complete radio receiver—light, durable, efficient, molded, soft neoprene sarcups, shaped to snugly and comfortably envelope the entire ear. Everyone BRAND NEW. Complete with illustrated manual. Send money order or check today. Special per pair \$1.89 Plus 25c each for postage. WRITE FOR BULLETIN R H  
**NIAGARA RADIO SUPPLY CORP**  
160 Greenwich St., New York 6, N. Y.

# BONAFIDE VALUES

 <p><b>SHURE T17B</b> Push Button Carbon Mike <b>88¢</b> With Cord and Plug Value \$12.00</p>	 <p><b>SHURE CRYSTAL MIKE</b> <b>\$6.95</b> With Stand, Base and 7 Ft. Cable Value \$18.50</p>
--	---



**HAZELTON INSTRUMENT CO. MODEL 100**  
Pocket Multimeter 2" Movement, 1000 ohms PV, A.C. Volts 0-15, 150, 1500; D.C. Volts 0-15, 150, 300, 1500; Ohms 0-3000, 300,000; Mils 0-1.5, 15, 150 ..... **\$9.95**

**STAR TUBE TESTER. COMPACT 7x8 INCHES. LATEST TYPE TUBES ..... \$29.95 COMPLETE**

**SUPERIOR #680 REG. 27.65 5000 OHM PER VOLT VOLT-OHM MILLIAMETER ..... \$18.75**

**MODEL B-45 ALL-WAVE SIG. GENERATOR. REG. \$27.75 ..... \$24.95**

**MODEL 1553 VOLT OHM-MILLIAMETER. REG. \$24.95... \$17.45**



**DETROLA AUTO-MATIC RECORD CHANGER**  
Plays 10- and 12-inch records. **\$14.49**

**Webster #50 Changer ..... \$21.00**

**Webster #56 Changer Auto-matic Stop ..... 25.95**

**Seeburg Changer, "2 post" ..... 21.97**

**Maguire Changer 2 post Auto-matic Stop ..... 11.95**



**2 TUBE PHONO OSCILLATOR**  
Complete with tubes, 35Z5, 12SA7. Use with record player, and tune in on any radio.  
Complete. **\$4.75**  
All Wired

**3 Tube PHONO AMPLIFIER Volume and tone control ALL WIRED with Tubes. \$4.95**

**ASTATIC OR SHURE Pick Up ..... 2.25**

**A.C. Phono Motor ..... 2.25**

## ELECTROLYTIC CONDENSERS

10 MFD—35 Volts .....	19c ea.
10 MFD—50 Volts .....	19c ea.
25 MFD—25 Volts .....	19c ea.
.01-006—600 Volts .....	9c ea.
20-20—150 Volts .....	26c ea.
20-20-30—150 Volts .....	39c ea.
40-40—150 Volts .....	39c ea.
50-50—150 Volts .....	39c ea.
½ MEG. Vol. Control-Switch.....	49c ea.

No less than 6 assort'd sold

## MISCELLANEOUS

8 section telescopic aerial .....	\$1.95
100 Asst. Resistors, 1RC, etc. ....	\$1.79
HS 30V Earphones .....	.98
2 Gang Condenser .....	.79

25% Deposit, Bal. C.O.D. Plus Charges  
Write for Latest Catalog

## BONAFIDE RADIO CO.

89½ Cortlandt St., Dept. H, N.Y. 7, N.Y.

# RADIO SET AND SERVICE REVIEW

(Continued from page 32)

the high range, the signals beat with the second harmonics of the v.f.o. to produce the 500-kc difference frequency for working into the fixed i.f. amplifiers.

### The circuit

The primary of the antenna coil, L6, is designed for most efficient operation with a 300-ohm antenna or transmission line. Incoming signals appear on the grid of the 6AK5 pentode r.f. amplifier. They are amplified and impedance coupled to the signal grid of the 6SA7 mixer through L12 in the 6AK5 plate circuit. Here the signal beats with the harmonics or fundamental of the crystal oscillator to produce frequencies in the range of the variable i.f. amplifier (2.5 to 1.5 mc or 5.5 to 3.5 mc) depending on the position of the band switch. A variable i.f. transformer, L13 and L16, is used between the 6SA7 and the 6SK7 high-frequency i.f. amplifier. The tuning slugs of the transformer are ganged to the tuning control so the transformer is always resonated to the 6SA7 output frequency.

The signal from the 6SK7 is applied to the No. 3 grid of the 6L7 second mixer. Signals from the 6SJ7 permeability-tuned v.f.o. beat with the high-frequency i.f. and produce the 500-kc fixed i.f.

The 500-kc output of the 6L7 feeds through a crystal filter into a conventional-stage high-gain i.f. amplifier using a pair of 6SG7's. The filter is between the output of the mixer and the grid of the first i.f. stage. Unwanted signals are rejected with the phasing control. Selectivity of the filter is con-

trolled by varying the amount of resistance in the circuit. When the 4700-ohm resistor is in the circuit, the Q of the filter is highest and its selectivity is greatest.

A part of the signal from the plate of the second i.f. stage is applied to the plate of the 6SJ7 a.v.c. tube through a 100-μuf condenser. When the signal is great enough to drive the plate more positive than the cathode, the tube conducts, developing a voltage across the 470,000-ohm resistor between the plate and ground. The grid of the 6SJ7 is connected to a positive point on the detector load resistor. This voltage aids in cancelling the delay bias on the cathode so full a.v.c. is developed across the 470,000-ohm plate resistor. Control voltage is taken from the plate through a.v.c. filters and applied to the r.f. and variable i.f. amplifiers and to the second fixed i.f. amplifier.

A 6H6 second detector and noise limiter follow the 500-kc i.f. stage. The detector diode works into a high impedance load that effectively clips all negative audio peaks above the 35% modulation level. The other diode of the 6H6 is a series noise limiter designed to clip positive audio peaks at the 35% modulation level. Limiter operating voltages are taken from the detector load resistor so all signals are clipped at the same level regardless of the carrier strength.

The b.f.o. circuit is conventional. Its frequency is variable 1,000 cycles either side of the i.f. center frequency by a control on the panel. Voltage from the b.f.o. is injected at the detector plate.

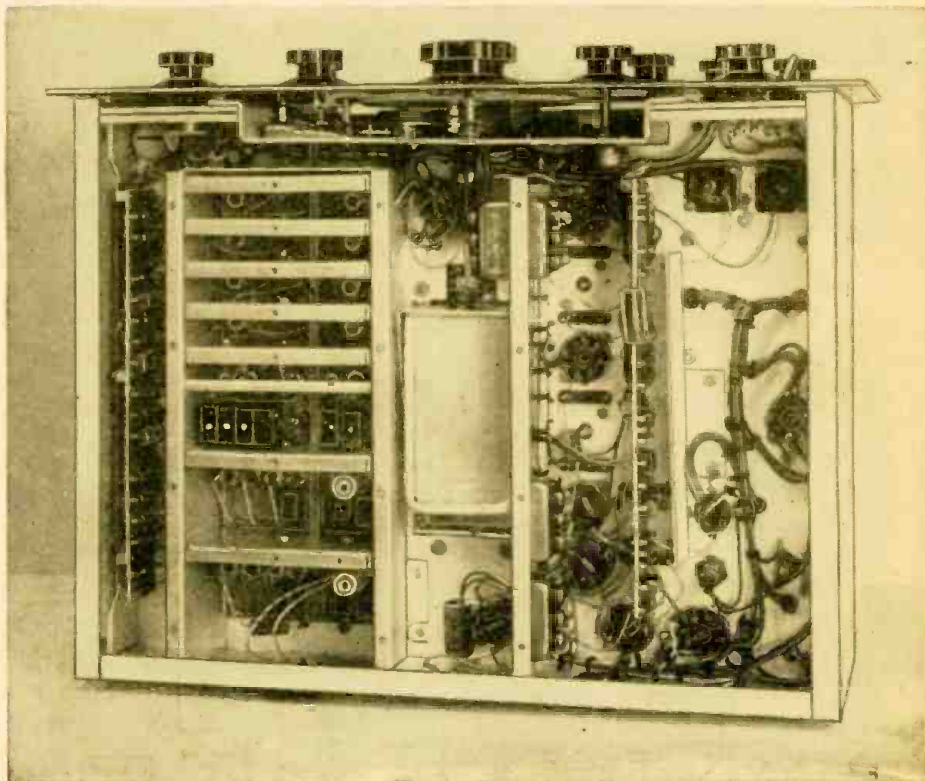

Under-chassis view of the receiver. Crystals can be seen in the compartment left of center.

## OUTSTANDING SPECIALS!!

Immediate Delivery from Stock

The New  
Model B-45  
Battery  
Operated

### SIGNAL GENERATOR

for servicing AM, FM and Television Receivers. R.F. frequencies from 150 Kilocycles to 50 Megacycles (150 Kc. to 12.5 Mc. on Fundamentals and from 11 Mc. to 50 Mc. on Harmonics). Complete with shielded test lead, self-contained batteries and instructions. NET ..... \$27.75

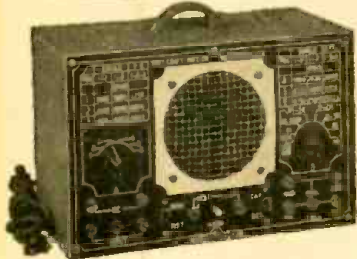
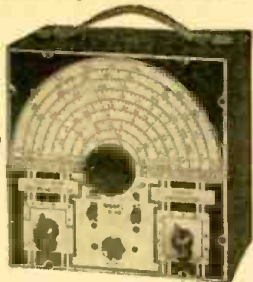

The New Test-Craft

### COMBINATION TEST SPEAKER

A new combination test speaker plus resistor substitutor; plus condenser substitutor; plus resistor tester; plus condenser tester; plus output meter. External voice coil connection permits testing of set-speaker to determine if output transformer is open or shorted. Field impedance: 500, 1000, 1500 and 2500 ohms at 175 Ma. ....Net price \$27.50

**Metropolitan ELECTRONIC & INSTRUMENT CO.**

Dept. RC 42 WARREN ST. N. Y. 7, N. Y.

## Craft Pal

### THE COMBINATION DRILL GRINDER



ONLY  
\$8.95

The "Craft Pal" is a combination Drill and grinder, complete with MOTOR-CHUCK-GRINDING WHEEL-SET OF 5 GRINDING STONES-STEEL WASHERS-LOCK PIN.

Home Craftsmen, Hobbyists, Small Shop Owners will find "Craft Pal" indispensable for doing light duty grinding and drilling. Motor is cool-running, 1/20 H.P., 60 C, 110 volts A.C., 3500 R.P.M., with finger control switch.

SEND NO MONEY - FILL IN AND MAIL TODAY

MINOR MACHINE CORP.  
45 N. Division St., Buffalo, N. Y., Dept. RC  
Send parcel post C.O.D. one "CRAFT PAL"  
complete with full equipment for \$8.95.

Name.....

Address.....

Charges Paid If Money Accompanies Order

MINOR MACHINE CORP., 45 N. Division St.  
BUFFALO, N. Y.

The audio amplifier and power supply are conventional. The output tube develops about 2.5 watts into 400- or 500-ohm loads. A phone jack is provided. The headphone circuit is designed for 500-ohm phones but high-impedance phones work well.

The illuminated S-meter is connected between the cathodes of the variable i.f. amplifier and the second mixer. Sensitivity and zero-set controls are provided for correcting the meter for different antennas and receiving conditions. The meter is calibrated to S9 at half scale and to 60 db above S9 at full scale.

The antenna, r.f., variable i.f. and variable oscillator circuits are tuned by powdered iron slugs which are moved through the cores of L6, L12, L13, L16, L17, L20 and L001. These inductors, except L001, are tuned to the 80-meter band with a semi-variable condenser combination consisting of a fixed condenser and a trimmer. When the set is tuned to other bands, parallel-tuned circuits are connected across the 80-meter inductors to raise the effective resonant frequency to the frequency of the band in use. In each case, the 80-meter inductors are the only ones varied by the tuning controls. In the rear-view photograph, the cover has been removed to show the oscillator shielding compartments. The permeability-tuned v.f.o. is in the center of the set. The movable platform supporting the tuning slugs is just to the right of the shield between the compartments.

#### Performance

The electrical stability of this set is far superior to any we have seen. Checking the calibration of the set by tuning in signals of known accuracy from a crystal-controlled oscillator, it was possible in all cases to hit the frequency right on the nose just by reading the dial of the set. If there is any receiver that will satisfy FCC requirements for frequency-measuring equipment for amateur stations, the Collins 75A-1 is one that will do the job. The set was tuned to zero beat with WVV on 15 mc less than 1 minute after it had been turned on. After being on five hours, only a very low audio note was audible in phones or on the external speaker. While the set was in this condition, it was subjected to mechanical shock without any detectable change in frequency.

### U.H.F. SWEEP GENERATOR



Courtesy Vision Research Laboratories

A service instrument for modern use, this sweep signal generator covers a range from 5 to 100 mc and 170 to 216 mc in 4 ranges, with sweep variable from 500 kc to 10 mc.

## Get this free! radio book

Mail coupon today for buying guide to the best values in Radio, Ham and P.A. Equipment. Send, too, for the hot-news Supplement jam-packed with bargains.

100,000  
BARGAINS  
RADIO  
P.A.  
HAM

## LAFAYETTE SPOTLIGHT VALUES

Worth \$9.00

### EMERSON

12" PM Speaker

only \$4.95



This remarkable speaker has an Alnico 5 Magnet and was manufactured for Emerson by RCA. One piece cone, heavy metal frame. Excellent for replacement or new installations. Less output transformer. Shipping weight 9 lbs. ....No. KPS271.

### EDWARDS FM FIDELOTUNER



connects to any receiver or sound amplifier.

only  
\$31.50

This highly efficient tuner brings you delightful, noise-free FM with its revolutionary High Q Tuning Lines.\* Newest Features: discriminator circuit. Three IF stages including limiter. Permeability tuned IF and Disc "K-Trans". Slide rule dial for easy fingertip tuning. Full range 88 x 108 Mc. 5 tubes plus selenium rectifier. VHF insulation throughout. Local reception antenna included. Tubes: 3-6SH7, 1-6J6, 1-6H6, 105-130 V, 60 cycle. AC operation. Size: 11" x 6" x 6 3/4". Shipping weight 7 1/2 lbs. ....No. K20360. \*Pat. Pend.

## Lafayette Radio

(RADIO WIRE TELEVISION, INC.)  
100 SIXTH AVE., N. Y. 13  
110 FEDERAL ST., BOSTON 10  
542 E. FORDHAM RD., BRONX 58  
24 CENTRAL AVE., NEWARK 2, N. J.

#### CLIP COUPON AND MAIL NOW!

LAFAYETTE RADIO, Dept. JB-8  
100 Sixth Avenue, New York 13, N. Y.

Rush Catalog No. 88 ( )  
Supplement No. 88s ( )

Enclosed is check or money order for  
( ) Speaker KPS271 @ \$4.95 each  
( ) Fidelotuner K20360 @ \$31.50 each

Name .....

Address .....

City ..... Zone..... State.....

# RADIO-TELEVISION- ELECTRONIC PARTS & EQUIPMENT SPECIALS

## THREE TUBE PHONO AMPLIFIER

An assembled unit ready for installation using tone and volume control and six feet of rubber cord ..... Price **\$2.95**  
(Not including Tubes)

With Complete Set of Tubes ..... \$3.95

## PHONO OSCILLATOR

Wireless phono oscillator transmits recording for crystal pick-ups or voice from carbon mike through radio without wires. Can also be used as an intercomm by using P.M. speaker as mike. Price (excluding tubes) **\$2.95**  
With Complete Set of Tubes ..... \$3.95

## TELEVISION-CATHODE RAY HIGH VOLTAGE

2000 volt D.C. Power Supply

For an unbelievably low price, we can supply a completely filtered television or cathode ray 2000 volt D.C. power supply. Why bother with bulky and dangerous 60 cycle supplies or expensive R.F. power supplies when you can purchase a complete 2000 volt D.C. unit (not a kit), ready to plug into the 110 volt A.C. power line. The ridiculously low price has been made possible by a fortunate purchase of high quality components. These units are brand new, completely tested and guaranteed. Here are the advantages:

- Low cost
- 2000 volts D.C. at 1 ma.
- Safe
- Small size
- Completely wired and tested
- Ready to connect to your television set or other equipment
- Will operate from 110 volts. Power line

PRICE ..... **\$7.95**

## A SCIENTIFICALLY DESIGNED SCRATCH FILTER

Resonated at approximately 4500 cycles effectively reducing objectionable needle scratch without altering the brilliancy of reproduction. Contains a HI-Q SERIES resonated circuit. Tested by means of an audio oscillator and an oscilloscope to give 22 db. attenuation with very low signal loss. Attenuation may be regulated by means of a SPECIAL MINIATURE gain control.

### EASY TO ATTACH

Just two wires to clip on to the leads coming from phone pick up. **\$1.65**  
Compact. Price

## POCKET SIGNAL GENERATORS

High quality pocket-size signal generators for alignment of radio receivers in the shop or home. Can be easily carried on the job to speed up troubleshooting and repair—makes a good impression on the customer. The frequencies are selected by means of a selector switch. Two models available as follows, size of either unit only—3"x6"x2 3/4":

### MODEL 720 FM

Alignment frequencies are: 108 MC., 98 MC., 88 MC. for the Ant. & R.F., 10.7 MC. for the I.F. These frequencies are frequency modulated by a 400 cycle tone. **\$19.50**  
Price only

### MODEL 710—BROADCAST BAND

Alignment frequencies are: 550 and 1500 KC. for the Ant. & R.F., 465 and 456 KC. for the I.F.'s. Modulation by a 400 cycle tone. Price only **\$17.95**

## Special!!

We offer an excellent buy in unused surplus 2" Westinghouse Voltmeters. Range 0-30 volts D.C. These may be converted to make voltohmmeters, etc. Your price only **\$1.65**

Satisfaction guaranteed on all merchandise. All prices F.O.B. New York City.

WRITE FOR CATALOGUE

**RADIO DEALERS SUPPLY CO.**

135 Liberty St. New York, N. Y.

## MAGNETIC RECORDING

(Continued from page 54)

used for more than 1,000 plays without any appreciable reduction in volume level.

If the dispersion is not homogeneous, a characteristic clumping takes place. This deposits an uneven coating and also prevents the formation of a smooth series of magnetic islands on the tape. When clumping occurs, pronounced level variations are noticed at the high frequencies.

Surface smoothness is one of the most important characteristics required for low background noise. Surface smoothness is obviously a function of particle size and dispersion.

### Electrical circuits

Fig. 1 shows the complete schematic circuit of the modern tape recorder-reproducer. To simplify tracing the re-

the special post (post-recording) equalizer, consisting of C7, R12, R13, and C9. The network composed of R11, C34, R14 and C10 provides a variable high-frequency attenuating and accentuating control so the over-all response of the unit may be adjusted to the listener's preference. Note that the playback head is resonated with condenser C26 for additional low-frequency boost.

The playback amplifier is more in the nature of a monitor than a high-fidelity playback unit. If an external amplifier and loudspeaker is to be used, it should be tapped in at the input grid of the 6SL7. In fact, if a single-pole, double-throw switch is used to connect the center of R14 either to the 6SL7 for the monitor amplifier or to an external amplifier, a perfect switching arrangement will be provided.

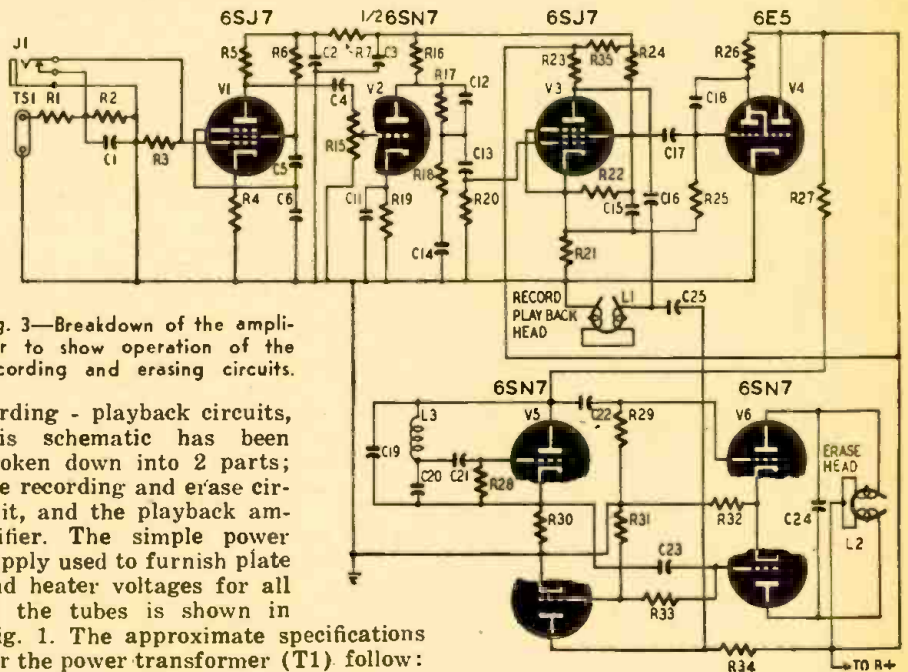

Fig. 3—Breakdown of the amplifier to show operation of the recording and erasing circuits.

ording - playback circuits, this schematic has been broken down into 2 parts; the recording and erase circuit, and the playback amplifier. The simple power supply used to furnish plate and heater voltages for all of the tubes is shown in

Fig. 1. The approximate specifications for the power transformer (T1) follow:

Primary: 117 volts, 50/60 cycles

High-voltage secondary: 325-0-325 volts, 100 ma

Rectifier filament: 5 volts, 2 amperes

Heater circuit: 6.3 volts, 4 amperes

Two voltages are taken from the power supply: one directly from the rectifier output which delivers approximately 360 volts at 20 ma and the other from the output of the filter circuit (labeled choke output) which delivers approximately 350 volts at 75 ma. The output ripple at this point is less than 0.2 volt.

The playback amplifier is indicated in Fig. 2. This circuit is fairly conventional in design, with the exception of

Because of the exceptionally high gain of the amplifier, it is extremely important that unusual precautions be taken to avoid excessive hum pickup. Take extreme care in the grounding circuits of the input stage. Note also that only one-half of V2 is utilized in the playback amplifier. The other triode section of the 6SN7 (V2) is utilized in the recording amplifier, which is illustrated in Fig. 3.

The recording and erase amplifier circuits are the most complex, as they include a low-power recording amplifier, an electron-tube overload indicator, a supersonic bias oscillator, an isolating

**ELECTRIC SOLDERING IRON \$1.00**

**SENSATIONALLY PRICED**

Not a toy—the real McCoy. Mighty Mite Electric Soldering Iron with new, amazing "Demon-Heat" element performs like soldering irons costing many times more. Handiest electric soldering iron ever offered for hobbyists, home workmen, mechanics. 35 watts 110-120 volts. **GUARANTEED.** No COD orders. Price \$1.00 includes mailing. Dealers write for quantity prices. **OHIO FACTORY SALES, 10314 Superior Ave., Dept. RC, Cleveland, Ohio.**

**ROTA-BASE**

NEW HANDY LAB. DIAL actually gives a "prong" picture of radio tube connections. **INSTANTLY, ACCURATELY.** No more valuable time lost thumbing pages or on lengthy readings. Filament, grid, plate, cathode, etc., to more than 300 tube types are shown. **NOW ONLY \$1.00** postpaid, or sent C.O.D. plus postage. Order **TODAY**, money refunded if you are not delightfully pleased.

**REED MFG. CO.**  
11350Z Burbank Blvd. N. Hollywood, Calif.

## TECHNICAL KO's

Power Xformer 850 VCT, 750 VCT @ 200 Ma, 5V @ 3A, 6.3V @ 5A.....\$4.14  
 6V6 Metal.....\$.89 6L6 Metal......95  
 12SQ7 Metal......32 12K8 Metal......32  
 .01-150V Paper (Midget)......60 for 1.00  
 .02-600V Paper......10 for 1.00  
 .1-1600V Paper......12 for 1.00  
 Mica—.002, .005, .006, etc..... 600V .08  
 Cond. Kit .01-.00001......100 for 3.00  
 Bathtub Kit 3 x .1, .5, 1, etc......10 for .89  
 Resistor Kit 1/2 & 1w, Assorted......100 for 1.49  
 Choke-Thordarson 12H-80Ma-250 ohms.. 1.09  
 Choke-Thordarson 10H-100Ma-250 ohms.. 1.09

### OIL-FILLED G. E. C. D. ETC.

Value	Price	Value	Price
.05 MFD 1000 V	\$.28	.000025 2500 V	\$0.11
.1 2500 V	.60	.00005 1600 V	.12
.1 7500 V	1.85	.00005 2500 V	.14
2x.1 7000 V	4.75	.00005 5000 V	.95
.12 15000 V	5.95	.000067 2500 V	.20
.25 1000 V	.35	.00007 2500 V	.14
.25 4000 V	2.75	.00025 2500 V	.25
.25 6000 V	4.00	.00025 5000 V	.95
10x.25 600 V	1.00	.0004 2500 V	.18
.5 600 V	.28	.0005 2500 V	.18
.5 1000 V	.35	.00072 5000 V	.95
.5 2000 V	.40	.0008 5000 V	.95
.5 3000 V	.60	.001 2500 V	.18
.75 2000 V	.55	.0015 5000 V	.95
.77 350 VAC	.35	.002 2500 V	.27
1.0 1000 V	.45	.002 3000 V	.66
2.0 1000 V	.60	.0025 1200 V	.15
4.0 600 V	.60	.00275 2000 V	.28
4.0 1000 V	1.00	.003 2500 V	.30
6.0 1000 V	1.25	.004 2500 V	.36
6.0 2000 V	1.75	.005 3000 V	.66
8.0 600 V	.70	.006 2000 V	.33
8.0 1000 V	1.75	.008 1200 V	.12
10.0 600 V	.85	.01 1200 V	.14
30.0 330VAC	2.35	.02 600 V	.11

\$2.00 min. order F.O.B. N.Y.C. Add postage  
 50% deposit, balance C.O.D. with all orders.  
 Manufacturers Inquiries Invited.

## TECHNICAL RADIO PARTS CO.

265 Greenwich St. Dept. RC-8 N.Y. 7, N.Y.

## NEW EQUIPMENT FOR OLD

You can trade-in your old test equipment, any make, any type, on these new Supreme test instruments at ALMO. See the table below for the amount allowed on your old equipment towards purchase of these nationally-known Supreme test instruments.

Model	Regular Cost To You	Your Trade-in Allowance	Net Cost To You
504-8 Tube & Set Tester	\$89.50	\$15.00	\$ 74.50
546-A Oscilloscope	89.75	20.00	69.75
561 Oscillator	136.60	25.00	111.60
562 Audolyzer	127.00	22.00	105.00
563 Generator	62.95	12.50	50.45
565 Vacuum Tube Voltmeter	63.59	20.00	43.50
567 Set Tester	63.40	12.50	50.90
574 Set Tester	67.45	12.50	54.95
576 Oscillator	68.95	12.50	56.45
589 Portable Tube Tester	48.95	10.00	38.95
589 Counter Tube Tester	58.95	10.00	48.95
592 Set Tester	58.95	15.00	43.95
599 Portable Tube Tester	62.50	10.00	52.50
599 Counter Tube Tester	74.00	12.50	61.50

Write for More Details

10% Cash with Orders  
  
 Phone LO 3-9255  
 Covers the Globe

509 ARCH STREET  
 PHILADELPHIA, PENN.

amplifier, and a supersonic power amplifier for erasing. It will be noted that 2 inputs are provided: one high gain which connects directly into the control grid of the 6SJ7 (V1) for microphone use, and the other through a dropping and compensating network into the same grid for high-level input (such as from a radio tuner). A special pre-equalizer circuit composed of R17, R18, C14, C12, C13, and R20 is utilized to provide a response curve which simulates the overload characteristic curve of the tape. One triode of V5 is employed as a 30-kc oscillator and inverter, which in turn feeds the erase amplifier V6, which is connected to the push-pull erase coil. The other triode of V5 is the isolating amplifier which feeds supersonic bias voltage to the recording head. Both the supersonic voltage and audio signal voltage are mixed into the recording heads through C25 and C16, respectively.

All of the electrical and mechanical recording equipment is housed in the central portion of the cabinet shown in the photograph at the head of the article, which illustrates a long playing tape recorder-reproducer capable of recording and playing back eight-hour programs.

Interior views of this unit will be shown in the concluding article of this series, which will also discuss the supersonic biasing, electronic erasing and the tape-handling mechanism.

In the meantime, the writer will be glad to answer questions addressed to him in care of this magazine. To insure speedy replies, please include a postage prepaid self-addressed envelope.

### PARTS LIST

#### RESISTORS

(All units 1/2 watt except where noted.)

CIRCUIT SYMBOL	DESCRIPTION
R1	470K
R2	22K
R3	470K
R4	1800-ohms
R5	220K
R6	1 meg
R7	22K
R8	1-meg potentiometer
R9	27K
R10	1K
R11	220K
R12	68K
R13	1 meg
R14	1-meg potentiometer
R15	1-meg potentiometer
R16	27K
R17	33K
R18	8200 ohms
R19	1K
R20	1 meg
R21	270 ohms
R22	27K
R23	47K
R24	33K, 1 watt
R25	1 meg
R26	1 meg
R27	27K
R28	100K
R29	100K

(Continued on page 78)

\$25.00 Value for Only \$1.89

8000 ohm Dual, Headset H-16/U—most sensitive phones built—noiseproof—may be used as a sound powered intercom—Also used with simple Xtal to make a complete radio receiver—light, durable, efficient, molded, soft neoprene earcups, shaped to snugly and comfortably envelope the entire ear. Everyone BRAND NEW. Complete with illustrated manual. Send money order or check today. Special per pair \$1.89 Plus 25c each for postage WRITE FOR BULLETIN R H



### NIAGARA RADIO SUPPLY CORP

160 Greenwich St., New York 6, N. Y.

PLEASE TEAR OUT THIS ADV. AS REMINDER

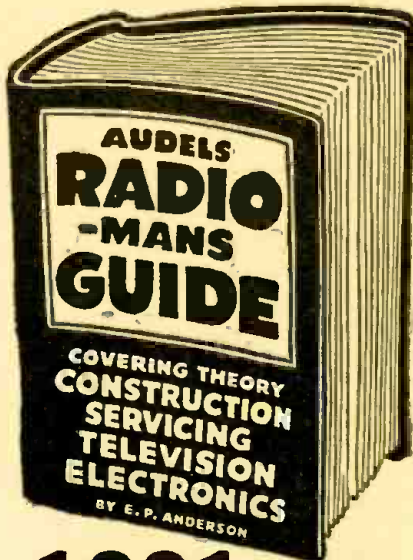

## 1001 RADIO FACTS AND FIGURES

AUDEL'S RADIO-MANS GUIDE—914 Pages, 633 Illustrations, Photos, Wiring Diagrams, 88 Big Chapters, covering Radio Theory, Construction, Servicing, including Important Data on Developments in Television, Electronics and Frequency Modulation, Review Questions and Answers, Calculations & Testing. Highly Endorsed—Indispensable for Ready Reference and Home Study.

**\$4 COMPLETE • PAY ONLY \$1 A MONTH**  
 Step up your own skill with the facts and figures of your trade. Audels Mechanics Guides contain Practical Inside Trade Information in a handy form. Fully Illustrated and Easy to Understand. Highly Endorsed. Check the book you want for 7 days' Free Examination.

Send No Money. Nothing to pay postman.

## CUT HERE MAIL ORDER

AUDEL, Publishers, 49 W. 23 St., NEW YORK 10, N. Y.

Please send me postpaid for FREE EXAMINATION books marked (x) below. If I decide to keep them I agree to mail \$1 in 7 Days on each book ordered and further mail \$1 monthly on each book until I have paid price—otherwise, I will return them.

- RADIO-MANS GUIDE, 914 Pages..... \$4
- ELECTRICIANS EXAMINATIONS, 250 Pages..... 1
- WIRING DIAGRAMS, 210 Pages..... 1
- ELECTRIC MOTOR GUIDE, 1000 Pages..... 4
- ELECTRICAL DICTIONARY, 9000 Terms..... 2
- ELECTRICAL POWER CALCULATIONS, 425 Pgs..... 2
- HANDY BOOK OF ELECTRICITY, 1440 Pages..... 4
- ELECTRONIC DEVICES, 216 Pages..... 2
- ELECTRIC LIBRARY, 12 vol., 7000 Pgs., \$1.50 vol..... 1
- OIL BURNER GUIDE, 384 Pages..... 1
- REFRIGERATION & Air Conditioning, 1280 Pgs..... 4
- POWER PLANT ENGINEERS Guide, 1500 Pages..... 4
- PUMPS, Hydraulics & Air Compressors, 1658 Pgs..... 4
- WELDERS GUIDE, 400 Pages..... 1
- BLUE PRINT READING, 416 Pages..... 2
- SHEET METAL WORKERS Handy Book, 388 Pgs..... 1
- SHEET METAL PATTERN LAYOUTS, 1100 Pgs..... 4
- AIRCRAFT WORKER, 240 Pages..... 1
- MATHEMATICS & CALCULATIONS, 700 Pgs..... 2
- MACHINISTS Handy Book, 1600 Pages..... 4
- MECHANICAL Dictionary, 968 Pages..... 4
- AUTOMOBILE GUIDE, 1700 Pages..... 4
- DIESEL ENGINE MANUAL, 400 Pages..... 2
- MARINE ENGINEERS Handy Book, 1280 Pages..... 4
- MECHANICAL DRAWING GUIDE, 160 Pages..... 1
- MECHANICAL DRAWING & DESIGN, 480 Pgs..... 2
- MILLWRIGHTS & Mechanics Guide, 1200 Pgs..... 4
- CARPENTERS & Builders Guides (4 vols.)..... 6
- PLUMBERS & Steamfitters Guides (4 vols.)..... 6
- MASONS & Builders Guides (4 vols.)..... 6
- MASTER PAINTER & DECORATOR, 320 Pgs..... 2
- GARDENERS & GROWERS GUIDES (4 vols.)..... 6
- ENGINEERS and Mechanics Guides
- Nos. 1, 2, 3, 4, 5, 6, 7 and 8 complete..... 12
- Answers on Practical ENGINEERING..... 1
- ENGINEERS & FIREMANS EXAMINATIONS..... 1

Name.....

Address.....

Occupation.....

Employed by..... B.C.F.

# MAKE MONEY!

## ASSEMBLING COIN RADIOS

Thousands of dollars have been made during the past year by wide awake radio service men who have installed coin radios in Hotels, Hospitals, Motels and Tourist Cabins. Great demand—No experience necessary.

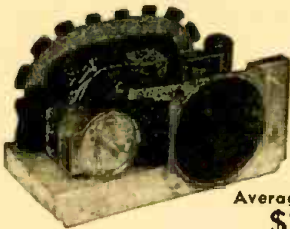
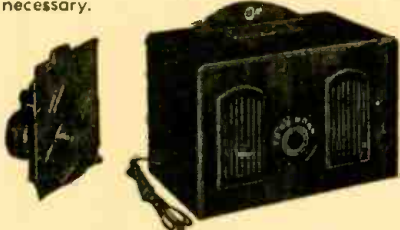

Just  
**3**  
Steps

Average Profit  
**\$25 Per Set**

If Sold Outright  
Much More If Operated on a Rental Basis!  
We supply complete chassis with 6 tubes, quarter coin slot and one or two hour timer ready to place in walnut cabinet. Furnished with foolproof lock and coin box. Fill out order blank and mail to:

**EICHEL ELECTRONIC CORP.**  
EVANSVILLE 8, INDIANA

## FILL OUT...MAIL

EICHEL ELECTRONIC CORP.  
EVANSVILLE 8, INDIANA  
PLEASE SHIP ME

NO.	DESCRIPTION	AMT.
	Cabinets with lock @ \$ 6.75	
	6 Tube Chassis @ 18.65	
	5 Tube Chassis (including plastic auxiliary case) @ 16.50	
	Timers @ 6.50	

I understand either of the above chassis with the timer and cabinet include all of the parts for your latest model coin operated radio.

NAME .....  
STREET NO. ....  
CITY and STATE .....

# RECORDS

## LATEST & HARD-TO-GET BACK NUMBERS

Some slightly used and some brand new—Victor, Bluebird, Columbia, Okeh, Decca, Capitol, etc. Such artists as Glenn Miller, Benny Goodman, Harry James, Bing Crosby, Frank Sinatra, Gene Autry, Duke Ellington, Fats Waller, Guy Lombardo, Andrews Sisters, Kate Smith, Ink Spots, Mills Bros., etc.

**BIG PROFITS** Your opportunity to cash in on this new field that is sweeping the country. Specify the type of music that sells best in your territory such as Swing, Sweet Music, Cow-boy, Hill-billy, Polkas, Blues, etc. Your price \$13.50 per hundred records, f.o.b. Chicago. All shipments made within 48 hours.

**CHAS. HOODWIN CO.**  
4419 Broadway, Dept. B7, Chicago 40, Illinois  
World's Largest Dealers in Used Records

## MAGNETIC RECORDING

(Continued from page 77)

R30—27K	R38—27K, 1 w
R31—47K	R39—470K
R32—680 ohms	R40—22K
R33—100K	R41—680 ohms
R34—15K, 1 w	R42—470K
R35—2200 ohms	R43—27K, 1 w
R36—470K	R44—680 ohms
R37—68K	R45—100 ohms, 10 w

### CAPACITORS

(600-volt working except where noted.)

C1—.0005 $\mu$ f
C2, 3, 6—3 x 20- $\mu$ f, 450-v electrolytic
C4—.02 $\mu$ f
C5—.1 $\mu$ f
C7—.02 $\mu$ f
C8—.05 $\mu$ f
C9—.002 $\mu$ f
C10—.002 $\mu$ f
C11—.05 $\mu$ f
C12—.0025 $\mu$ f
C13—.01 $\mu$ f
C14—.05 $\mu$ f
C15—.02 $\mu$ f
C16—.1 $\mu$ f
C17—.1 $\mu$ f
C18—.0001 $\mu$ f
C19—.001 $\mu$ f
C20—.01 $\mu$ f
C21—.01 $\mu$ f
C22—.001 $\mu$ f
C23—.001 $\mu$ f
C24—.0005 $\mu$ f
C25—.0005 $\mu$ f
C26—Values determined by head
C27, 28—2 x 20- $\mu$ f, 450-v electrolytic
C29—.01 $\mu$ f
C30—.01 $\mu$ f
C31—.01 $\mu$ f
C32—.02 $\mu$ f
C33—.02 $\mu$ f
C34—.001 $\mu$ f

### TUBES

V1—6SJ7	V4—6E5	V7—5Y3
V2—6SN7	V5—6SN7	V8—6SL7
V3—6SJ7	V6—6SN7	V9—6SN7

### MISCELLANEOUS

T1—Power transformer
T2—Output transformer
CHI—10H, 75 ma
J1—Jack (microphone)
TS1—Radio input
TS2—External speaker
SPK—8-inch permanent magnet
M1, 2, 3—115-v a.c. synchronous motor
SW1—Toggle s.p.s.f.
SW2—Rotary 4Zp.d.t.
SW3—Reverse-limit d.p.d.t.
SW4—Forward-limit d.p.d.t.
SW5—5 push-buttons
F1—Glass-type 2, amp
L1—Record-playback head
L2—Erase head
L3—50 mh.
Rectifier—Federal No. 403D2625

## QUESTION BOX

(Continued from page 42)

frequency above the present value of about 290 to 300 kc.

The coil mounting and winding will depend on the materials that you use and your ingenuity in applying them. Remember that a supply of this type is dangerous! The final coil must be well insulated. High-voltage leads should have gradual bends and also should be insulated against corona discharge.

Construction of the coils is shown in Fig. 2. Coils are wound as follows: L1—32 turns, approximate, of No. 28 d.c.c. magnet wire. L2—1,400 turns of 3/44 Litz wire wound in 7 pies of 200 turns each and 5 turns per layer in each pie. L3—approximately 55 turns No. 32 enamel. The number of turns may be varied to obtain proper grid excitation for the 6Y6. For L4 and L3 use No. 24 d.c.c. wire and wind a fractional turn or so to get 1.25 volt at 0.2 ampere for the filament of each 8016.

The spacing of the windings from each other may have to be varied for best results, but the order in which they are shown should remain the same.

## A BUYER'S MARKET



### Famous Make Crystal Pickup

An exceptionally fine, lever-type crystal pickup. Gives smooth response, very low surface noise. Needle force 1 1/2 ozs. Output 1.6 Volts.... **\$1.79**



### "Utah" 2,000 Ohm DUAL HEADSET

A favorite, high quality, dependable headset. Highly sensitive, practical phones for every headset use. Has adjustable, flexible metal-split headband; 4 1/2 Ft. covered cotton cord ..... **\$1.79**

### BY-PASS CONDENSERS



600 VOLT STANDARD BRAND

mfd	price ea.	price per 100
.01	.07	\$ 6.00
.02	.07	6.00
.1	.13	12.00
.05	.11	10.00
.001	.07	6.00
.002	.07	6.00
.005	.07	6.00
.25	.16	15.00

## TUBE SPECIALS!

BRAND NEW STANDARD BRAND	list	Our Special!
1LN5	\$2.65	96c
0Z4	2.20	95c
35Z5GT	1.15	46c
50L6GT	1.50	60c
12SA7GT	1.80	72c
12SK7GT	1.50	60c
12SQ7GT	1.50	60c
35W4	1.15	45c
6J6	2.65	79c
50B5	2.80	70c

### OTHER SPECIALS

8x16 Mfd., 450 V. Tub. Electrolytic Condenser..	69c
20 Mfd., 450 V. Can Condenser: inverted neck...	89c
50 Mfd./50 V. Condenser .....	39c
40 Mfd., 450 Can Condenser: inverted neck mtg.	99c
40 Mfd., 150 Condenser .....	39c
50-L-6 Output Transformers .....	44c
1 meg & 2 meg. 500,000 Ohm Vol. Cont. with switch & Tap .....	54c
100 mfd 25 volts Tub. Cond. ....	29c

### Television Condensers

.05	2500 Working Volts
.03	Tubular
.02	Type

**SPECIAL 63c each**

Antenna Loops—Medium Size .....	\$ .24
Selenium Rectifiers—100 mill .....	.74
8 inch PM Alnico 5 Magnet .....	3.49
12 inch PM Speaker, Alnico 5 Magnet handle up to 10 Watts .....	4.79
#22 Solid Pushback wire, 100 Ft. rolls; Var. Color .....	.40
#40, #42, #44, #46, #47 PILOT LAMPS, Box of 10 .....	.44

All Merchandise is standard brand, brand new and 100% Guaranteed. No Seconds! No Rejects! No off-brands!

## GREEN RADIO DISTRIBUTORS

Electronic Supplies & Equipment

482 SUTTER AVENUE  
BROOKLYN, NEW YORK

The House of Bargains

20% Deposit Required with C.O.D. Orders. All orders FOB New York. Minimum orders \$2.00.



## SIGNAL TRACER

(Continued from page 34)

as cover and chassis are slid into place.

A similar procedure is followed for the battery and headphone jack leads. The battery leads should be shielded by running them in a length of shield braid soldered to the can. The audio and r.f. probes are the easiest of all to construct. They are made from heavy tinned-copper wire so bent as to make it easy to reach into the more inaccessible corners of a receiver chassis. The r.f. probe is soldered directly to one terminal of the trimmer and brought through the can cover with an insulating rubber grommet. Outside the can the probe is covered with spaghetti to within 1/4-inch of the end to avoid shorting out any of the receiver wiring. The audio probe is similar in construction except that it is soldered to an insulated terminal strip mounted inside the can cover. Both terminal strip and trimmer should be securely mounted to support the probes. The probes must be kept short to prevent unwanted pickup. It must be remembered that they are merely terminals and not antennas. A word of caution about the audio probe blocking condenser. Be sure it is of high enough voltage rating to stand any voltage that might be encountered.

A convenient length of wire with an alligator clip on one end is fastened to the can to provide a common connection between the tracer and the radio chassis. All parts must be chosen for size. The smallest wattage ratings in resistors and other parts are permissible in most cases, as the power is small. The new midget volume controls and r.f. chokes are good.

The signal tracer—if properly constructed—should be able to pick up a signal directly from the grid of the first r.f. or mixer stage. If the capacitance has been kept low enough, there should be no necessity for retuning the dial while checking r.f. stages. The relatively low impedance of the audio probe circuit may load the grid circuits of some first audio amplifiers. But I have yet to experience this difficulty.

In conclusion, all that you have to do is flip the switch and touch the r.f. probe from point to point, following the signal from stage to stage. The audio probe is ready with a twist of the wrist as soon as you have passed the detector. Now and then it will be necessary to turn the volume control down as you approach the receiver output.

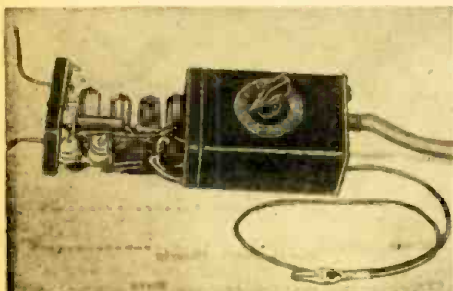

A view of the tracer partly out of its case.

## NUMBERS 4 and 5 OF THE WALSCO Hit Parade

THE SENSATIONAL, NEW, SCIENTIFIC

### WALSCO STANDARD TEST RECORD

FOR IMMEDIATE . . . ACCURATE . . . AUDIBLE ADJUSTMENT OF RECORD CHANGERS AND COIN OPERATED PHONOGRAPHS . . . SOLVES THE PROBLEM OF ADJUSTING PICKUP AND TRIPPING MECHANISM THROUGH **SOUND!**



- Three Tone lead-in grooves—permits immediate adjustment to proper set down position of the pick-up through audible means.
- Made to RMA and NAB standards.
- Record plays in less than 40 seconds.
- Audio tone at end of record indicates proper adjustment of tripping action.

The WALSCO Standard Test Record saves time and increases efficiency in the adjustment of record changers and coin operated phonographs. Write for full information.

## WALSCO UNIBELT

THE UNIVERSAL DIAL DRIVE BELT CAN BE CUT TO FIT ANY DIAL DRIVE

Will not Slip or Stretch

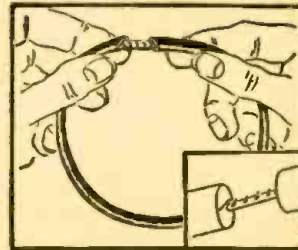

"UNIBELT" comes in 5-foot length spools and can be installed without taking dial mechanism apart. A real time and money saver. Eliminates the need for stocking numerous sizes of belts.

Free sample and literature, Write to Dept. 2B

## WALSCO products

Help The Radio Man

WALTER L. SCHOTT CO. BEVERLY HILLS CALIF. CHICAGO 5, ILL.

### SPEAKERS

5" Alnico 5 Magnet, 98¢  
P.M. each

10 for \$9.50

6" 2.15 oz. Alnico 5 Magnet, \$1.69  
P.M. each

10 for \$15.00

All other sizes in stock, at money saving prices.

### WIRE

400 ft. (approx.) of wire in assorted colors and gauges, solid & stranded in 2 to 4 feet lengths, per pkg. 99¢

### Volume Controls

1 MEG. volume control with switch and long shaft, ea. 49¢

6 for \$2.75

15 Assorted Volume and Tone Controls (less switches) \$1.95

### RESISTOR KIT

100 Insulated Resistors, 1/2, 1 & 2 Watt \$1.95

### PHONO SUPPLIES

Crystal Pickup Arms... \$1.98  
Phono Motor and Turntable 2.95  
I.F.'s 455 KC. 39¢

### CONDENSERS

Tubular Paper (600 V. Test)

Mfg.	Price Ea.	Per 100
.01	.08	\$ 6.50
.02	.08	6.50
.05	.10	8.00
.1	.12	9.00
.25	.17	13.50
.001	.08	6.50
.002	.08	6.50
.005	.08	6.50
.006	.08	6.50
.5	.26	22.50

"Illinois" Electrolytics

Mfd.	VDC	Price each
10	25v	.30
100	25v	.48
12	50v	.34
16	150v	.36
20	150v	.38
24	150v	.38
30	150v	.40
50	150v	.48
8	450v	.38
10	450v	.42
16	450v	.54
20	450v	.60
40	450v	.80
100	15v	.45

"Illinois" Duals

16-16	150v	.50
20-20	150v	.52
30-30	150v	.60
40-20	150v	.60
30-30	150v	.68
8-8	450v	.68
10-10	450v	.74
20-20-20	150v	.84

10% discount on all electrolytics if purchased in lots of 10 or more. Mica Condensers, all sizes, 8c each.

Minimum Order \$3.00—20% with Order. Balance C.O.D.—WRITE FOR CATALOG. TWO CONVENIENT PLACES FROM WHICH TO ORDER. PLEASE ADDRESS DEPT. C2

### ELECTRONIC DISTRIBUTORS, INC.

620 W. Randolph St., Chicago 6, Ill.

### ELECTRONIC PARTS CORP.

436 W. State St., Milwaukee 8, Wisc.

## Do you need BINDING POSTS?



The XL PUSH POST with its Spring Action assures Constant Contact and quick connection. Manufactured in All Aluminum Type M at 12c each. Aluminum Body. Bakelite Top Type B1 at 15c each. Types CP or NP. ALL BRASS—STAINLESS STEEL SPRING & PIN. PROVEN BY 240 HR. SALT SPRAY TEST as NON-CORROSIVE at 28c each. Manufacturers and Dealers Liberal Discounts

### X. L. RADIO LABORATORIES

420 West Chicago Ave., Chicago 10, Ill.

ONE television receiver is equal to at least 5 1/2 radio receivers in terms of spectator appeal, says Huber Hoge, advertising agent for U. S. Television. A survey shows that on an average weekday evening 30% of the radios in an area are in use, but that 52% of the

## TINY RADIO FITS IN YOUR HAND!



Really works too! Unbreakable Streamline Red Plastic Cabinet! NO TUBES. BATTERIES OR ELECTRIC "PLUG-INS" NEEDED! Easy to use—Even a child can do it!

GUARANTEED TO WORK FOR YOU ON LOCAL RADIO PROGRAMS! USE MOST ANYWHERE—AT HOME, IN SCHOOL, HOTELS, OFFICES, ON FARMS, IN BED, ETC.

SEND ONLY \$1.00 (bill, money order, check) and pay postman \$2.99 plus C.O.D. fees on arrival or send ONLY \$3.99 for postpaid delivery! COMPLETE—READY TO PLAY with personal phone—MARVELOUS GIFTS FOR BOYS OR GIRLS! ORDER YOUR TINY RADIO NOW AT THIS LOW BARGAIN PRICE! (Foreign \$5.00 C.W.O.) PAKETTE PRODUCTS COMPANY, INC. Dept. TRC-2, Kearney, Nebraska.

televisers in the same area are operating. Further, each television receiver has an average of 6.26 persons watching it, while the average audience per radio set is 2.5.

# OPPORTUNITY FOR RADIO MEN!

Think of it! The average American home has at least 11 electric motors in it. Large homes have from 15 to 25—in washers, record players, oil burners, clocks, fans, mixers, refrigerators, etc. No wonder, then, that motor repair is a good, well-paid business! It's a real "natural" for radio men to learn—and this big new book, **ELECTRIC MOTOR REPAIR** (see below) teaches you fast—teaches you right! Send coupon today!



**I'll Make it EASY for you to LEARN PROFITABLE ELECTRIC MOTOR REPAIR**

.. at only \$5 for the complete, 553-page Course!

**ELECTRIC MOTOR REPAIR** book by the publishers of Ghirardi Radio-Electronic books is a gold mine for radio men who want to expand along logical, profitable lines in an uncrowded field. Based on this big book alone, you can train for prompt, profitable service on practically ANY TYPE OF MOTOR IN COMMON USE—from fractional horsepower motors in home appliances, to big industrial motors. It tells exactly how to do everything from simple adjustments and repairs to complete rewinding. Covers AC and DC motors, synchronous motors and generators and mechanical, electrical and electronic control systems.

**IT PAYS TO SPECIALIZE IN "SOMETHING DIFFERENT"**

Every step of the work is explained simply as A-B-C, both in text and by more than 900 specially prepared diagrams and illustrations. No guesswork! Each phase of motor repair is clearly shown so there can be no mistaking. Quick reference guides show step-by-step how to handle specific jobs. When a motor comes in for repairs, just turn to **ELECTRIC MOTOR REPAIR** and see what to do. It's an ideal book, either for beginners or for bench use in busy shops. Unique Duo-Spiral Binding divides book into two sections with text on one side, pictures on the other. Lies flat on the bench.

## MONEY-BACK GUARANTEE

Send coupon now. **PRACTICE** from **ELECTRIC MOTOR REPAIR** for 5 full days—**AT OUR RISK**. Actually fix motors for yourself and friends. Then, if not more than satisfied, return book to us and **EVERY CENT OF YOUR MONEY WILL BE CHEERFULLY REFUNDED**. No questions asked!

**"BORROW" IT FOR 5 FULL DAYS!**

**NO RISK COUPON mail today**

Dept. RC-28, Murray Hill Books, Inc., 232 Madison Ave., New York 16, N. Y.

Send me a copy of **ELECTRIC MOTOR REPAIR** for which I enclose \$5 (\$5.50 foreign); or  send C.O.D. and I will pay postman \$5 plus postal charges. If I then decide I don't want the book, I'll return it within 5 days of receipt and you guarantee to refund my \$5 and no questions asked!

Name .....

Address .....

City & Zone ..... State .....

## RADIO RECORD PLAYER

(Continued from page 71)

denser to mount the other components.

Now all the wiring may be done, except the connection between the modulator plate and the tank coil. Use good-quality components and see that they are rigidly mounted. Any loose or swinging part will cause microphonics. Use small chassis terminals where necessary. All ground connections in the oscillator-modulator circuit should be made with heavy copper wire to a common point. Do not rely on soldering to the chassis. At 100 mc these points may spell the difference between success and failure.

The next step is making the coil. Use copper (or silver-plated) wire, No. 14 or larger. It is absolutely essential that the coil be as rigid as possible. It consists of 3 turns with an inside diameter of 3/4 inch. The one shown was made by winding the wire over the bakelite shell of a standard phone plug, then slipping it off. The turns should be pulled out so that coil length is about 1 inch. Leave about 1 1/4 inches of extra wire at each end of the coil.

Now connect the coil directly to the tuning condenser. No coil form or other support is necessary. Using heavy wire—No. 14 or better—connect the modulator plate to the coil about 1/2 turn up from its grid end. This wire, like all the connections, should be short and direct. Do not try for orderly appearance in v.h.f. equipment—just connect everything from point to point.

Now insert all the tubes and apply power. Check filament voltages. Place a 1,000-ohm-per-volt meter across the high voltage and adjust the power-supply filter resistor until output is between 15 and 20 volts. With the transformer used in the model, 225,000 ohms gave an output of 18 volts.

Next comes the question of whether the oscillator is oscillating. Disconnect the lead which carries high voltage to the oscillator modulator. Insert a 0-10-ma meter. Open the tuning condenser about 1/4 of its range, and turn on the power. If the unit is oscillating, the meter needle will rise slowly, suddenly pause, then continue up a slight distance. To check, put a finger near or on one end of the coil. If current changes when the finger is applied and removed, the oscillator is percolating merrily.

If no oscillation is found, check tubes and connections; then remove the modulator plate connection from the coil and try again. If oscillation is now observed, check all modulator connections (including grid and cathode). If there are still no results, try moving the modulator plate tap to a slightly different spot on the coil.

Setting the frequency may be the longest process of all, unless the reader is luckier than the writer. With power on, tap the coil lightly with a neutralizing tool or pencil and slowly tune the receiver over the band until a twanging sound is heard. If results are nil, change

## HARD-TO-GET PARTS

POWERFUL ALL-PURPOSE INDUCTION MOTOR

IDEAL FOR EXPERIMENTERS—101 USES



Sturdily constructed to precision standards, this self-starting shaded pole A.C. induction motor is powerful enough for a number of uses. Some of these are: Automatic Timing Devices, Current Interrupters, Electric Fans, Electric Chimes, Window Displays, Photocell Control Devices, Electric Vibrators, Small Grinders, Buffers and Polishers, Miniature Pumps, Mechanical Modulators, Sirens, and other applications.

Consumes about 15 watts of power and has a speed of 3,000 r.p.m. When geared down, this sturdy unit will constantly operate an 18-inch turntable loaded

with 200 lbs. dead weight—**THAT'S POWER!**  
Dimensions 3" high by 2" wide by 1 3/4" deep; has 4 convenient mounting studs; shaft is 7/8" long by 3/16" diameter, and runs in self-aligning oil-retaining bearings. Designed for 110-20 volts, 50-60 cycles, A.C. only. Shp. Wt. 2 lbs.  
ITEM NO. 147  
YOUR PRICE ..... **\$2.95**

## ULTRA MAGNET

LIFTS MORE THAN 20 TIMES ITS OWN WEIGHT

LITTLE GIANT MAGNET

Lifts 5 lbs. easily. Weighs 4 oz. Made of ALNICO new high-magnetic steel. Complete with keeper. World's most powerful magnet ever made. The experimenter and hobbyist will find hundreds of excellent uses for this high quality permanent magnet. Measures 1 3/4" x 1 1/4" Shp. Wt. 3 1/2 lbs.  
ITEM NO. 159  
YOUR PRICE ..... **\$1.50**



## GENUINE MICROPHONE TRANSMITTERS



Regular telephone transmitters taken from a large telephone supply company's overstock. Work perfectly on 2 dry cells. Can be used on P.A. systems, call systems, intercommunications as well as short-line telephone circuits, house-to-house or farm-to-farm phone lines, also to talk through your own radio or as concealed telephone pick-up. Useful replacements on battery-operated rural telephone lines.

**TRANSMITTERS, MADE BY KELLOGG, WESTERN ELECTRIC AND STIMBERG-CARLSON**, excellent in appearance and operation, remarkable value and one seldom offered in these times. Shp. Wt. 1 lb.  
ITEM NO. 160  
YOUR PRICE ..... **\$2.10**

## WATTHOUR METER



Completely overhauled and ready for immediate service. Designed for regular 110-volt, 60 cycle, 2-wire A.C. circuit. Simple to install; 2 wires from the line and 2 wires to the load. Sturdily constructed in heavy metal case, 8 1/2" high, 6 1/2" wide, 5" deep. Westinghouse, G. E., Wayne, Sangamo or other available make Shp. Wt. 14 lbs.  
ITEM NO. 33  
YOUR PRICE ..... **\$7.50**

## AMAZING BLACK LIGHT!!

Powerful 250 Watt Ultra-Violet Source



The best and most practical source of ultra-violet light for general experimental and entertainment use. Makes all fluorescent substances brilliantly luminescent. No transformers of any kind needed. Fits any standard lamp socket. Brings out beautiful opalescent hues in various types of materials. Swell for amateur parties, plays, etc. to obtain unique lighting effects. Bulb only. Shp. Wt. 2 lbs.  
ITEM NO. 87  
YOUR PRICE ..... **\$1.95**

## WESTERN ELECTRIC BREAST MIKE

This is a fine light-weight aircraft carbon microphone. It weighs only 1 lb.

It comes with breastplate mounting and has 2-way swiveling adjustment so that it can be adjusted to any desired position. There are 2 woven straps, one goes around neck, the other around chest. Straps can be snapped on and off quickly by an ingenious arrangement.

This excellent mike can be adapted for home broadcasting or private communication systems. By dismounting breastplate, it can be used as desk mike.

Comes complete with 6-foot cord and hard rubber plug. Finished in sherdarized plate, non-rustable. Shipping weight, 2 lbs.

ITEM 152  
YOUR PRICE ..... **\$1.49**

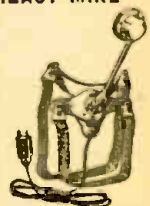

## HUOSON SPECIALTIES CO.

40 West Broadway, Dept. RC-2-48, New York 7, N. Y.

I have circled below the numbers of the items I'm ordering. My full remittance of \$..... (include shipping charges) is enclosed (NO C.O.D. ORDERS UNLESS ACCOMPANIED WITH A DEPOSIT.) OR my deposit of \$..... is enclosed (20% required). Ship order C.O.D. for balance. NO C.O.D. ORDER FOR LESS THAN \$5.00. BE SURE TO INCLUDE SHIPPING CHARGES.  
Circle Item No. wanted:  
147 159 160 87 152 33

Name .....

Address .....

City .....

Please Print Clearly

State .....

# RADIO TUBES

For immediate shipment

R.M.A. Guaranteed  
Below Distributor Costs  
Individually Sealed Cartons

Type	Price
6K6GT	.40
6K5GT	.46
6V6GT	.46
6SA7GT	.46
6SJ7GT	.46
6SK7GT	.46
6SQ7GT	.46
6X5GT	.40
12SA7GT	.46
12SQ7GT	.46
12SK7GT	.46
12SJ7GT	.46
35L6GT	.40
35Z5GT	.32
50L6GT	.46

RATED ACCOUNTS—2% 10 DAYS  
ALL OTHERS 2% C.O.D.

10% DISCOUNT ON LOTS OF 50 OR MORE

**RAVAC ELECTRONICS CORP.**

432—4th Avenue  
New York 16, N. Y.

**FOR THE "HIGHS"  
In High Fidelity ...**

use the new

**UNIVERSITY  
TWEETER**



**Quick, Easy  
Installation!**

It's a fact! This new tweeter gives you full range reproduction right up to 15,000 cycles when used in conjunction with any standard cone speaker. Quickly attaches to the voice coil terminals of your present cone speaker through a simple, inexpensive high pass filter. Available in handsome walnut cabinet or in single or dual unit unmounted types. Prices from \$20.00. For details write today to UNIVERSITY LOUDSPEAKERS, INC., 80 South Kensico Avenue, White Plains, New York.

*University Loudspeakers*

the setting of the oscillator tuning condenser and repeat. If you still have no luck, try squeezing and expanding the coil. Eventually, the oscillator will be located between 88 and 108 mc.

With the coil and condenser specified, the unit will not quite cover the entire FM band. So select the portion which is most free from signals in your locality, and, by adjusting the condenser and squeezing the coil, set the oscillator to some even-numbered dial division for easy location in the future. Use an insulated screw driver to adjust the condenser—it's hot at both r.f. and d.c.

After frequency has been set, you will notice that the oscillator is very microphonic. This is principally because the coil twangs like any piece of similar metal. To make it more rigid in the model, a plexiglass strip about 1/8 inch wide was cut to the length of the coil and glued to it with Duco cement.

The phonograph connector is on the rear apron of the chassis. Connect a crystal pickup to it and play a record. Volume may be adjusted with the potentiometer mounted on the front chassis apron. Most inexpensive crystal pickups will produce enough output to modulate the oscillator almost completely. This can be checked by listening first to an FM station, then to a record.

If a low-level pickup or microphone is to be used, a preamplifier stage will be necessary. Any ordinary resistance-coupled triode or pentode is suitable, depending on the gain needed. It can be mounted easily on the chassis.

It may prove useful to experiment with the value of plate voltage. This can be done by substituting different values for the power-supply filter resistor. Experiment shows, however, that much higher voltages will not be successful. Whatever voltage produces loudest receiver output is best.

The volume control actually controls frequency swing or deviation. If input from pickup or preamplifier is high, it will be found that increasing the control too much causes distortion.

Any of the usual equalization circuits may be used at the input. Pre-emphasis of highs may be desirable, since FM receivers incorporate de-emphasis.

Any article on phono oscillators—even FM oscillators—should end with the following solemn warning! Unless you have enough surplus income to pay a heavy fine or enough spare time to permit you to waste some of it behind bars, DON'T USE AN ANTENNA!

**NOW *Sound***  
**FOR YOUR SILENT PROJECTOR**  
*Economically*

**\$5.95**

Convert your 16mm silent projector to sound (regardless of make) with Apex sound head & radiofilm adapter. Guaranteed excellent performance. Write today for free information.

APEX VIDEO • 12209 U Brantford St. • Roscoe, Calif.

**TUBULAR ELECTROLYTICS**

**Fresh stock Fully guaranteed**

20 mfd. 150 V.	10 for \$1.79
20-20 mfd. 150 V.	10 for 2.49
8 mfd. 450 V.	10 for 1.85

Postage extra. 25% deposit on COD.  
Write for our free bargain lists featuring "AMERICA'S BEST BUYS"

**POTTER RADIO CO.**  
1312-1314 MeGee St. Kansas City 6, Mo.

# LEEDS

The Home of RADIO

In Our 25th Year

QUALITY!! DEPENDABILITY!! PRICE!!



**ATTENTION!!  
ALL SCR-522 OWNERS**

Remote Control Boxes for SCR 522's, Brand New in Original Packing; Consists of 5 push button switches, 5 Western Electric Pilot Assemblies, with Pilot Bulbs and Dimmer, and lever Switch all finished in Black Crackle. Order yours Today for only **\$1.25 ea.**  
Antenna Plug 46-PS-1 for 522A ..... 15c ea.

## I. T. & T. Selenium Rectifiers

Full Wave Bridge Rectifier: 54 volts AC Input, 39 Volts D.C. Output at 1.2 Amps. Signal Corps. Spec. 4DO238. Special at **\$1.50**

Full Wave Bridge Rectifier: 144 Volts AC Input, 96 Volts DC Output at 1.1 Amp. Signal Corps. Spec. 9DO612B. Special at **\$2.50**

These Rectifiers Are All Brand New.

## 5-Inch Cathode Ray Tubes, Type 5BP1

Green Screen, Brand New in Original Cartons. All Scope Owners Will Want A Few At This Ridiculously New Low Price of **each \$1.45**

## Oil Filled Condensers

3x.2 Mfd 4000 VDC	Tobe	.98
2x.1 Mfd 7500 VDC	G.E.	2.00
.02 Mfd 8000 VDC	Aero	.98
16 Mfd 400 VDC	W.E. Co.	.98
10 Mfd 600 VDC	G.E. or C.D.	.98
1 Mfd 5000 VDC	Solar	2.95
2 Mfd 800 VDC	C.D.	.49
2 Mfd 1000 VDC	Aero	.79

## Another Leeds Special

We have just received some 6.3 Volt Filament Transformers at 6 Amps. They'll Go Fast At **each \$1.50**

## Variable and Mica Condensers

0.4 Mfd Aeroxox Mica Condensers, 600 VDC eff. in low loss moulded Bakelite Case.	<b>each 95c</b>
A Real Buy At	
APC-25 Trimmers, Screw Driver Adjusted 12 plates, 25 Mmfd. Silver Plated Variables.	<b>\$1.25</b>
.15 ea. 10 for	
25 Mmfd Balanced Stator variables, Polished Plates, Isolantite Insulation, Swell for V.H.F.	<b>\$2.50</b>
.29 ea. 10 for	
15 Assorted Silver Micas:	<b>95c</b>
All for	
.01 Mfd 600 VDC Postage Stamp Micas	<b>\$4.75</b>
.05 ea. 100 for	

Ouncer Transformers, Mike to Grid, 25:1 Ratio Low to High Impedance	<b>\$2.95</b>
.35 ea. 10 for	
Crystal Diodes 1N23A	<b>\$1.00</b>
.35 ea. 3 for	
De Jur Wire Wound Potentiometer 12 Watts, 20,000 Ohms.	<b>49c</b>

## RADIO TRANSMITTER & RECEIVER APS-13

17 Tubes

410 - 420 Mc: light weight fully enclosed.  
30 Mc. IF, complete with tubes 5-6J6; 9 - 6AG5; 2 - 2D21; 1 - VR-105; Schematic supplied with each unit.  
Only **\$11.95**



STEEL CHASSIS			
10x17x3	\$.38	11x17x3	\$.86
5x10x3	.87	13x17x3	2.22
7x13x2	.96	7x7x2	.63
10x14x3	1.35	4x17x3	.99
STEEL CANS AND BOXES			
3x4x2	.68	12x7x6	\$.68
4x5x3	.78	15x9x7	2.35
6x6x6	.99	11x12x3	2.25

If not rated 25% with order, balance C.O.D. All prices F.O.B. our warehouse New York. No order under \$2.00. We ship to any part of the globe.

## LEEDS RADIO CO.

75 Vesey Street, Dept. RCF  
Cortland 7-2612 New York City, 7

# 30,000

## RADIO SERVICE-TECHNICIANS READ



### EVERY MONTH

RADIO MAINTENANCE today fills a breach that has existed in the radio field for a long time. Already 30,000 servicemen read RADIO MAINTENANCE every month because it is devoted entirely to the Radio Service Technician. The RADIO MAINTENANCE staff specializes in the preparation of articles on every phase of Radio Maintenance in series form which may be filed and used for reference. The leading articles cover everything for the radio serviceman on Television, FM and AM; Test Equipment; Electronic Appliances; Tools; Antennas; Alignment; Troubleshooting; Repair; Construction; Pick-ups and Sound Amplification and Reproduction Equipment. Also, in RADIO MAINTENANCE each month there are departments on hints and kinks, the latest news of the trade, review of trade literature, radiomen's opinions, new products and news from the organizations. All articles are presented in a step-by-step precision style, clearly illustrated, with schematics, accurate photographs, specially prepared drawings, white on black charts, color diagrams, isometric projections and exploded views.

RADIO MAINTENANCE is not sold on newsstands

Binders in beautiful green simulated leather stamped in gold are now available for your RADIO MAINTENANCE magazines — see the current issue of RADIO MAINTENANCE for information.

RADIO MAINTENANCE MAGAZINE RC2  
460 Bloomfield Avenue,  
Montclair 5, N. J.  
Please send me RADIO MAINTENANCE for  
 1 year at \$3.00  Bill me later  
 2 years at \$5.00  Payment enclosed

Name .....  
Address .....  
City—State .....  
\*Occupation .....  
Title .....  
Employed by .....

\*Independent Serviceman — Dealer Serviceman—  
Service Manager—Dealer—Distributor—Jobber.

**BOLAND & BOYCE INC., PUBLISHERS**

## COMMUNICATIONS

### LICENSES—PRO AND CON

Dear Editor:

Why is it that the licensing of radio servicemen pops up every so often? Just who is back of this anyway? Why always pick on the radio man? What about the automobile mechanic, watch repairman, or refrigerator serviceman? Many a high-priced watch, good car, or refrigerator have been ruined by the so-called tinker. As a radio serviceman for many years, I have heard more complaints along this line than I have heard in regard to gyp radio servicing. It seems to me that, if the radio service profession kept its mouth shut along this line and let things take their own course, all would be well. Every time the public sees an article on licensing radio servicemen they get the idea we are a bunch of crooks out to give them a raw deal and charge 3 times as much as we should for our work.

It is no wonder our profession is the poorest paid of any in the world. Show me another trade that exposes their wholesale prices like we do. Anyone can write for a catalog, and open circulars by the dozen are sent through the mails for everyone to see. Mail-order houses sell tubes for less than we can buy them and then you expect us to charge a fair retail price without the public squawking. To top this off, every so often the bogieman jumps out and labels us as dishonest by yelling "License them!"

It's we and not the people who are making the fuss. I have to hide the December issue of RADIO-CRAFT for fear one of my customers will see the article and begin to wonder for just how much he is going to be taken. If you, who are always ballyhooing about licensing radio servicing, turned your thoughts to publishing articles in leading magazines on how the public should go about selecting reliable repairmen and get behind manufacturers to form service organizations such as Philco has, it would be a great help to us and the public. You always have and always will have crooks in service professions. No amount of licensing is going to clean up the situation.

This is still a free country where the public can take their servicing wherever they want, and it isn't our fault if they don't want to patronize reliable shops. I have seen people get taken and go right back for more. That's the gambling instinct in man, and it is also what keeps this the free country that it is today. No one has been seriously hurt but ourselves.

ALEX JOHNS,  
Johns Radio Shop,  
Dubuque, Iowa

Dear Editor:

Why all this fuss about controls? Who is going to be hurt? The sooner they control the radio servicing industry the better for all concerned. I am 40 years old—made my living all my life in radio.

## LEONARD'S

### WINTER PRICES

#### BEST VALUE HAZELTON

### MULTI TESTER RANGES

AC Volt ..... 0-1500  
DC Volt ..... 0-1500  
DC Mills ..... 0-150  
Resistance 0-300,000

**\$11.75**



### ELECTRONIC MEASUREMENTS

#### VOLOMETERS

101A 3" METER \$17.50 NET  
Model 101B

OPEN FACE 4" METER \$20.95 NET  
OPEN FACE PORTABLE

101AP 3" Meter \$21.50 net  
101BP 4" Meter \$24.95 net



### —LATEST—

### STAR MEASUREMENT TUBE TESTER

Quick operation—with Rotary Selector and lever switches tests all tubes up to 117 volts. Also tests individual sections such as diodes, triodes, pentodes, etc.



**\$29.95 NET**

### RECORD CHANGERS

WEBSTER 56—Automatic Stop ..... \$26.66  
DETROLA ..... 14.50  
SEEBURG—2 Post. .... 22.95

RCA CRYSTAL MIKE with table stand ..... **\$4.95**

12" P.M. SPEAKER 20 OZ. ALNICO MAGNET **7.75 NET**

6L6 Push Pull or Push Pull Parallel 50 watt. Completely shielded. 250 mill primary 5000 ohms—sec. 2-4-8-15-500 ohms. H-57—Special Lim. Quan. .... **\$5.19**

### PHONO MOTOR and PICKUP KIT

SPECIAL **\$4.95**

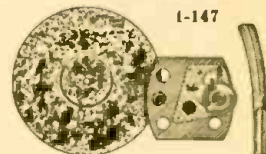

Complete

Crystal pick-up—Top quality constant speed motor. Motor Assembly only. \$3.95

Send 25% deposit with order—balance Express Collect. Orders under \$5.00 send check or money order plus postage.

## LEONARD RADIO INC.

69 CORTLANDT ST.  
NEW YORK 7, N.Y.

We are daily showing radiomen and beginners all over U. S. A. and Canada how to

**MAKE BIG MONEY QUICKLY—EASILY**

Our files bristle with letters of thanks. Why be satisfied with low income? What if you lost your job or business, or became ill and couldn't go to work? We have eye-opening information waiting for you, free.

Write Today  
MERIT, 216-32J 132nd Avenue  
Springfield Gardens 13, New York.

**SOMETHING REALLY NEW!**

Did you ever hear about magnets which can be made without metals? Or condenser-type microphones without condensers? Well, they can be made—thanks to a simple new technique for rearranging the atoms in plastics!

Familiarize yourself with this amazing new branch of science by reading Thomas A. Dickinson's book entitled **ELECTRETS**. If your bookstore can't sell you a copy, write for descriptive literature or send \$2.50 for a postpaid copy from:

Plastics Research Co.  
BOX 346, ALHAMBRA, CALIF.

**EASY TO LEARN CODE**

It is easy to learn or increase speed with an Instructograph Code Teacher. Affords the quickest and most practical method yet developed. For beginners or advanced students. Available tapes from beginner's alphabet to typical messages on all subjects. Speed range 5 to 40 WPM. Always ready—no QRM.



**ENDORSED BY THOUSANDS!**

The Instructograph Code Teacher literally takes the place of an operator-instructor and enables anyone to learn and master code without further assistance. Thousands of successful operators have "acquired the code" with the Instructograph System. Write today for convenient rental and purchase plans.

**INSTRUCTOGRAPH COMPANY**

4701 Sheridan Rd., Dept. RC, Chicago 40, Ill.

**\$25.00 Value for Only \$1.89**

8000 ohm Dual Headset H-16/U—most sensitive phones built—noiseproof—may be used as a sound powered intercom—Also used with simple Xtal to make a complete radio receiver—light, durable, efficient, molded, soft neoprene earcups, shaped to snugly and comfortably envelope the entire ear. Everyone BRAND NEW. Complete with illustrated manual. Send money order or check today. Special per pair \$1.89



Plus 25c each for postage. WRITE FOR BULLETIN R M

**NIAGARA RADIO SUPPLY CORP.**

160 Greenwich St., New York 6, N. Y.



**SPECIAL!  
SPECIAL!  
SPECIAL!**

Highest Grade Standard Output Transformers. Push-Pull 50L6 to 4 ohm Voice Coil ..... 49c  
Single 50L6 to 4 ohm Voice Coil ..... 39c  
Single 42, 43, 6V6, to 4 ohm V.C. .... 42c  
Filter choke 300 ohm, 70 mills. 10 by 39c

● Include sufficient money for postage; unused postage refunded. ● 20% deposit with order, balance C.O.D. Minimum order \$3.00.

Write for Giant Bargain Catalog.

**BUYERS SYNDICATE**

786 Carew Street Springfield, Mass.

**GREYLOCK**

**A Dependable Name in RADIO TUBES**

GT, Glass, and Miniature Types.

All Tubes Individually Boxed.

12SA7, 12SK7, 12SQ7, 50L6, 12AT6, 12BA6, 12BE6, 35W4, 50B5 ..... each 39c  
1R5, 1R5, 1T4, 354, 3Q4, 6AK5, 6AC5, 6AC7, 6AQ5, 6BE6, 6BA6, 6AU6, 6BJ6, 6X4 ..... each 49c  
32L7, 70L7, 117L7 ..... each 59c  
All Tubes Carry RMA 90-Day Guarantee

**PM SPEAKERS**

4" Alnico No. 5 ..... each \$1.19  
5" Alnico No. 5 ..... each 1.29

TERMS: Net COD. No order accepted for less than \$5.00

WRITE FOR BARGAIN CATALOG C-2

**GREYLOCK ELECTRONIC SUPPLY CO.**  
30 Church Street New York 7, N. Y.

I have attended shows, bought books and equipment, and maintained a complete stock of quality parts and tubes. I have worked long hours and given my community honest and—as far as my capabilities permitted—efficient workmanship.

In return I've been called a robber, a gyp, and every uncomplimentary name under the sun. Not by the 10,000 old customers on my books, but by the shopper who had been patronizing the fellows in a chain-store basement. I have spent hours putting a set back together after it was mutilated, and you know I didn't get paid for it. I have tried to defend my charges for quality parts when compared with fly-by-night competitive worse-than-surplus junk.

Who fears controls? Not the fellows who conduct their affairs honestly. Not the fellow who can pass the tests. Don't try to kid an old-timer, son! Controls will encourage the good men in the industry, will elevate the radio technician and his profession to a level consistent with the effort he must spend to be worthy of the name serviceman. Free enterprise?—you bet I'm all for it. Let any doctor practice who has passed through his internship and is qualified and ethical—but clear out the quacks!

ED. CRAWFORD,  
Crawford Radio Service,  
Hibbing, Minnesota

**NOVA SCOTIAN OPINION**

Dear Editor:

Permit me a few minutes of your time to express my appreciation to you for the publication of a fine magazine. Although working for a newspaper, I am an ardent radio fan, and during the recent differences in international opinion served with the RCAF in the Radio Division as a technician. I buy practically every radio magazine published, and find RADIO-CRAFT the best in its line. I also note that in Canada we pay 35c now, and believe me, if the price were again raised, I would still buy the magazine. I have every copy of RADIO-CRAFT for the past number of years, and credit the magazine with keeping me up-to-date on the ever-changing field of radio-electronics. Please accept my sincere thanks for your smart publication.

J. F. MACLEOD,  
Sydney, Nova Scotia

**LIKES CONSTRUCTION**

Dear Editor:

I speak for 10 or 15 friends here in St. Louis who have a superficial knowledge of radio but not too much practical experience.

We like stories on building small receivers, amplifiers, phono oscillators, etc., also instructive articles on design of receiving and sound equipment. Since the hams have their own specialized magazines, I think you would do well to consider the many who have not the time, money, or equipment to go in for transmitters, television, or other more advanced aspects of the field.

(Continued on page 84)

**Get a new ELECTRIC SOLDERING IRON FREE**

and assemble your own **MAGI-KLIPS** RADIO & ELECTRONIC EXPERIMENTER'S KIT



This is the same MAGI-KLIPS Kit—complete with all parts—that we sell ready assembled for \$29.75.

In knocked-down form with full instructions for assembly, it is now available at the **\$19.75** new low price.

..... complete with a new Electric Soldering Iron—the ideal iron for wiring your unassembled MAGI-KLIPS Kit.

Remember, you build 18 different experiments with your MAGI-KLIPS Kit. You actually teach yourself radio and electronics and have a lot of fun at the same time.

**RADIO RECEIVER, HOME BROADCASTER, PHOTOELECTRIC RELAY, CODE PRACTICE OSCILLATOR, SIGNAL TRACER, REMOTE CONTROL RELAY, Phonograph Transmitter, Intercommunication Amplifier, Code Transmitter, Radio Frequency Oscillator, Telephone Line Amplifier, Electronic Switch, Phonograph Amplifier, Temperature Control Relay, Contact Detector, Electronic Metronome, Interval Timer (one-shot), Interval Timer (repeating).**

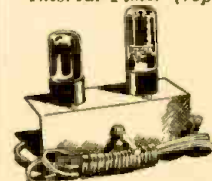

**PHONO-AMPLIFIER KIT**

A real bargain. Uses 35Z5 and 50L6. Complete diagram and instructions for assembling. Also good for call system.  
Kit Form ..... \$1.85  
Wired and Tested, 2.45  
Tubes for above... 1.65

**CODE PRACTICE OSCILLATOR KIT**

Learn the code! Get your ham ticket! Uses 50L6, 35Z5, 4" PM speaker. Tone and volume controls. Ideal for classroom instruction. Complete diagram and assembly instructions.

Kit Form ..... \$2.85  
Speaker and Transformer for above ..... 1.95  
Tubes for above ..... 1.65  
Wired and Tested, with Tubes and Speaker... 6.00

Terms: 20% deposit, balance C.O.D.  
Send for your copy of FREE booklet, "Electronics Made Easy."

**DEER & TAYLOR COMPANY**

Dept. C 1342 Milvia St. Berkeley 9, Cal.

**NOW AVAILABLE!**

*Amplifier for GE pickup*



New circuits for the first time enable you to attain full benefit from the new General Electric Model DL 1RM 6C Variable Reluctance Magnetic pickup. Employs an exclusive, humless (DC on heaters) pre-equalized pre-amplifier to produce the most satisfying musical amplifier the world has ever known. If you are a perfectionist, you are the one for whom the ACA-100GE was designed. Send for technical literature.

**AMPLIFIER CORP. of AMERICA**

398-10 Broadway • New York 13, N. Y.



IF YOU'RE INTERESTED in a steady year-in-and-year-out income—a substantial share of financial security for you and your family—you'll get in on the ground floor of this flourishing industry. You can build a lucrative business of your own NOW with TRADIO, the radio functionally-designed for coin operation in hotels, hospitals, tourist camps, motor courts, etc. Men and women like yourself all over the country are finding it a natural for big earnings and a steady income.

**TRADIO ★ Tried ★ Tested ★ Proven**

TRADIO has pioneered in this profitable postwar industry. Today, there are more TRADIOS installed throughout the country than any other coin radio.

Send for complete information and free illustrated brochure today. We'll put you in touch with the distributor in your territory if you'll phone Asbury Park 2-7447 or write Dept. U-2.



**TRADIO, Inc.** ASBURY PARK NEW JERSEY

**FREE**

UP TO THE MINUTE BUYING INFORMATION



Radio Repair Parts  
Sound Systems • Tools  
Kits • Phono Equipment  
Tubes • Test Instruments  
Experimenters Supplies

**REGULAR SUPPLEMENTS KEEP YOU POSTED**

Catalog sent immediately upon request. Price and Data Supplements, issued regularly, assure you of up-to-the-minute information—give exact and current data you need for profitable buying. Send the coupon today for this helpful buying service.

**BIG VALUES, LARGE STOCKS, FAST, DEPENDABLE SERVICE.**

**FREE...SEND TODAY**

RADOLEK CO., Dept. C-028  
601 W. Randolph St., Chicago 6, Ill.  
Please send your Free Profit Guide Catalog and regular Supplements.

Name .....  
Address .....  
City ..... Zone... State.....

**SAVE AT RADOLEK**

We are interested in wire-recording setups. Will you print some circuits soon? Also good high-fidelity amplifier circuits and some tuners.

CHAS. SHELDON,  
Kirkwood, Missouri

**LICENSES NOT NEEDED**

Dear Editor:

In reply to your recent editorial "Should Servicemen Be Licensed?" I would like to answer that they should not. For one thing, licensing often gets into the hands of state and city administrations, so that getting a license may depend on one's politics. For another, examinations test theory. An applicant may know the whole theory of radio and yet, if he has had no servicing experience, he can do more damage in a few minutes than can be repaired in several hours.

Our Association has been functioning for several years with very good results. An applicant must have 2 years' experience in a repair shop and own or have access to the necessary test equipment specified in the Association's By-laws. He must be examined and pay an initiation fee before he can become a member, and must pay dues and attend monthly meetings thereafter.

We have the cooperation of our local supply houses, which we find very helpful. I think if this method of solving the servicemen's problems could be adopted throughout the country, it would help curb many abuses and weed incompetent persons out of the service field.

SCOTT ADAMS,  
President,  
Radio Technicians Association,  
Huntington, West Virginia

**BASICALLY NEW THINGS**

Dear Editor:

Your magazine was recommended to me by a friend when I first started studying electronics about 12 years ago. I have read several other periodicals along with RADIO-CRAFT and can truthfully say that in my eyes there is and has been no better magazine. Most of those I have seen do not satisfy me like the RADIO-CRAFT I have known for the past 12 years.

Concerning your editorial policy, I admire your clear, frank, forthright honesty in whatever subject you deal with. I imagine it pinches in places always to follow that policy, but I admire you for it and earnestly hope you will continue to follow it in the future.

I like technical articles dealing with basic principles in electronics and always read with intense interest any article that describes something basically new. The electret you described some time back stuck in my mind and I have been hoping you would have more to say about it.

I am also delighted to see that Mr. Shaney is back with us again. I am confident he knows his business and his articles are written so I can understand and profit by them.

VAN BURTIS SPITLER,  
Findlay, Ohio

**ANOTHER New BROWNING DEVICE**

FM-AM TUNER Model RJ-12  
Superb FM reception; quality AM reception. Single antenna for both bands. Separate RF and IF systems on both bands. Armstrong FM circuit.

Frequency meters. WWV standard frequency callibrator Oscilloscope. Power supply and square wave modulator Capacitance Relay. FM-AM Tuners. FM Tuner.

KNOW THE ENTIRE BROWNING LINE • ENGINEERED FOR ENGINEERS

Write Dept. J for Catalog



**BARGAINS**

**FROM OUR FREE CATALOG**

TUBES: Pop. Brand, Sealed Carbons; order any Type, we have 'em all—60% to 80% off.

- 5 TUBE KIT: 50L4, 35Z5, 12SA7, 12SK7, 12SQ7 \$2.79
- 5 TUBE KIT: 50H5, 35W4, 12AT6, 12BA6, 12BE6 2.75
- 12SA7, 354, 6NY, 1T4, 6AK5, 12BD6, 636, 9001, 6AH6, 6AL5, 717A 69c ea.
- SPECIAL: 70L7 79c; 11A6 91c
- ACORN TUBES: 954, 955, 956, 957, 958A 49c
- HEAR. AID: CK501AX to CK509AX 49c

CONDENSERS: Fresh, Pop. Brand; order any type, we have 'em all—80% off.

- 30 @ 150—29c; 50/50 @ 150—59c; 16/16 @ 150—34c; 50 @ 150—39c.
- VOL. CONTROLS: ALL OMMAGES. ¼, ½, and 2 meg. with switch, 3" Shaft 47c
- 12" P.M. Speaker, Heavy Slug 44.95
- L-71 Pickup & Crystal Cartridge 11.89

LOWEST PRICES ANYWHERE WRITE FOR FREE CATALOG

Send 20% With Order—Bal. C. O. D.

**COMMERCIAL RADIO**

36 BRATTLE ST. Boston 8, Mass.

**\$25.00 Value for Only \$1.89**

8000 ohm Dual, Headset H-16/U—most sensitive phones built—noiseproof—may be used as a sound powered intercom—Also used with simple Xtal to make a complete radio receiver—light, durable, efficient, molded, soft neoprene earcups, shaped to snugly and comfortably envelope the entire ear. Everyone BRAND NEW. Complete with illustrated manual. Good money order or check today. Special per pair \$1.89 Plus 25c each for postage WRITE FOR BULLETIN R H



**NIAGARA RADIO SUPPLY CORP**

160 Greenwich St., New York 6, N. Y.

**SIGNAL - TRACER - GENERATOR**

- PENCIL PROBE
- HIGH GAIN TRACER
- BUILT-IN DETECTOR
- SIG. INJECTOR GEN.
- AC-DC OPERATION

ONLY \$16.50



Ready to operate—Signal Tracer with loudspeaker operation—Signal Generator—Multivibrator—Puts out strong A.F., I.F., R.F. signal 1000 cycles to 25 megacycles.

**PHONO-OSC...AMPLIFIERS**



PHONO - OSC - AMPLI - FIERS 35Z5, 12SQ7, 50L4 Hi-Gain, III-Fl, AC DC Amp. Complete \$4.69

Wireless Phono-Osc. Mike or Phono Inp. Complete with tubes \$4.49  
Wired \$4.49

**YORK DISTRIBUTORS**

523 Knickerbocker Ave., Bklyn. 21, N. Y.

**RADIO-FREQUENCY HEATER**  
(Continued from page 22)

This represents full load. If this point cannot be reached, try a different tap on the coil and proceed as before until the maximum plate current, not to exceed 0.6 amp, is reached. In some settings it may be found that a greater current than this will be drawn. In this case the plate overload relay will trip, cutting off the power. In such a case the coil tap must be changed again until the optimum setting is found. For most experimental work it will probably be desirable to have the key switch in the MANUAL position.

Some interesting and enlightening results may be obtained from this device. It is to be noted particularly that a mass of material will heat uniformly throughout, regardless of its thickness. This is in sharp contrast to what takes place in conventional heating, where thermal conduction must be depended upon to conduct the heat from the surface inward. It may readily be appreciated how important this feature becomes in various industrial applications. It is not uncommon for the time required for a given process to be reduced from several hours to a few minutes. Typical applications of this form of treatment are preheating of plastic preforms, setting of plywood, twist-setting of textiles, sealing of plastic sheeting and sterilizing of packaged cereals.

**ELECTRONIC VOLT-OHMMETER**

**\$11<sup>85</sup>**  
110 VOLTS AC 20 RANGES  
0/5/10/50/100/500/1000/5000 volts DC and AC. 0-1,000,000,000 ohms in six overlapping ranges. Sensitivity: over MILLION OHMS per VOLT on 5 volt range.

Complete kit includes all component parts, tubes, punched and drilled chassis and beautifully enamelled panel. Easily assembled and wired.

Special slideback circuit developed during war by scientist at the California Institute of Technology gives amazing sensitivity and flexibility while completely eliminating necessity of batteries and expensive meter. Each instrument is individually calibrated. Dial scale over nine inches long!

In addition to performing the usual volt-ohm functions, this instrument easily measures these voltages: SUPERHET OSCILLATOR, AVC, AFC, TRUE GRID BIAS AT THE GRID, BIAS CELLS without affecting the circuit. Measures the exact leakage resistance of INSULATION, TUBES, CONDENSERS. It can be used with a signal generator for SIGNAL TRACING.

**STERLING ELECTRONIC COMPANY**  
BOWLING GREEN, KENTUCKY

**COMMAND RECEIVERS (274N SERIES)**  
Complete with tubes

	Used	New
BC-948-B; 520 to 1500 KC	.....	\$12.95
BC-483-A; 15 to 50 KC	.....	6.95
BC-454-A; 3 to 6 MC	.....	3.95
BC-455-A; 6 to 9 MC	.....	5.95

**COMMAND TRANSMITTERS**

	Used	New
BC-696; 3 to 4MC	.....	\$5.95
BC-457; 4 to 5.3MC	.....	3.95
BC-458; 5.3 to 7MC	.....	3.95
BC-459; 7 to 9.1MC	.....	3.95
BC-456 MODULATOR	.....	BRAND NEW \$2.95

**RADIO PARTS**

Assorted-100 mica condensers	.....	\$1.19
100 Resistors 1/4 to 1 watt	.....	.95
100 Tubular bypass condensers, assorted	.....	.01
to 1.5 all 600 Volt	.....	4.69
Electrolytic condensers 50-30, 150 Volt	.....	10 for 2.89
1/2 Meg. Volume Controls 1" shaft with switch,	.....	10 for 3.00
1/2 Meg. Volume Controls 1" shaft without	.....	10 for 1.95
Crystal Pick-up, new light wt.	.....	ea. 1.79

**TUBES**

6V6	12J5	12S17GT	
6X5	6AT6	6AR5	
6AQ7	6SF7	10AC Neon	
35W4	5R4	12K8	49c
12AT6	12BE6	6SN7	Lots of 50
12SR7	12AG	6W6	10% Discount
1625	12C8	36	
Amperite 10T1	6SJ7	6GD6	

**SCOPE TUBES**

3AP1	.....	\$1.19
5FP7	.....	1.9C
3FP7	.....	\$1.19
7BP7	.....	1.98

All Shipments F.O.B. Chicago

20% deposit required on all orders

**ARROW SALES INC., Dept. D**

59 WEST HUBBARD ST., CHICAGO 30, ILLINOIS

Telephone: SUPERIOR 5975

**TOP VALUE OFFERS**



**Kit Model S-5**  
a 1-Band Receiver

Model S-5 uses the universally accepted superheterodyne circuit containing the following tubes: 12SA7, 12SK7, 12SQ7, 50L6, 35Z5 and tunes from 550 Kc. to 1600 Kc. Price of kit less tubes ..... **\$10.95**

**Kit Model S-6X**  
a 2-Band Receiver



Model S-6X, a 6-tube 2-band receiver kit covers the following ranges: 550 Kc. - 1600 Kc. 6-16 Mc. Complete with tubes and ready for assembly ..... **\$16.95**

**Also Available**

**MULTITESTER KIT MODEL M-3C**

A versatile, compact multimeter 4" x 7" x 3" using a 3 1/2" rd. meter of 1000 ohms per volt sensitivity. Employs the following ranges: Volts AC or DC 0/5/50/150/500/1500. Milliampere D.C. 0/5/50/150. Ohms 0/2000/20,000/200,000.

**Price Complete \$10.95**

All kits accompanied by a detailed illustrated instruction sheet. Many other kit models available. Write for catalog M.

Now ready! New educational pamphlet... complete and simplified diagrams and instructions on all our models ..... 50c

**RADIO KITS COMPANY**

120 Cedar Street, New York 6, N. Y.

Technicians Everywhere agree that when **BETTER AMPLIFIERS**

are made, it's A. C. Shaney who's "a-goin' to make them"

A. C. Shaney, long known as the outstanding designer of high-quality amplifiers, and his associates at the Amplifier Corp. of America, are getting ready to announce the completion of the finest line of public address and electioneering amplifier equipment ever produced.

New standards of quality and workmanship, new circuits, new materials, and new manufacturing processes have been combined to make this soon-to-be-announced amplifier line the answer to all requirements. Specifications and performance ratings of these popular-priced models will equal or surpass those formerly found only in high-cost, custom-built equipment. And Amplifier Corp. of America will guarantee every amplifier for 5 full years—an expression of confidence that only the country's leading and most thorough manufacturer of the most modern amplifier designs would dare make.

You can't afford to buy any amplifier until you have investigated the new concept in amplifier design and construction offered by A. C. Shaney and the Amplifier Corp. of America.

Join the many thousands who are "watching and waiting" for the latest in amplifiers from

**AMPLIFIER CORP. of AMERICA**

398-10 Broadway, New York 13, N. Y.

A postal card will put you on our mailing list to be among the first to know.

*Insist on Genuine*

**JAMES VIBRATORS**

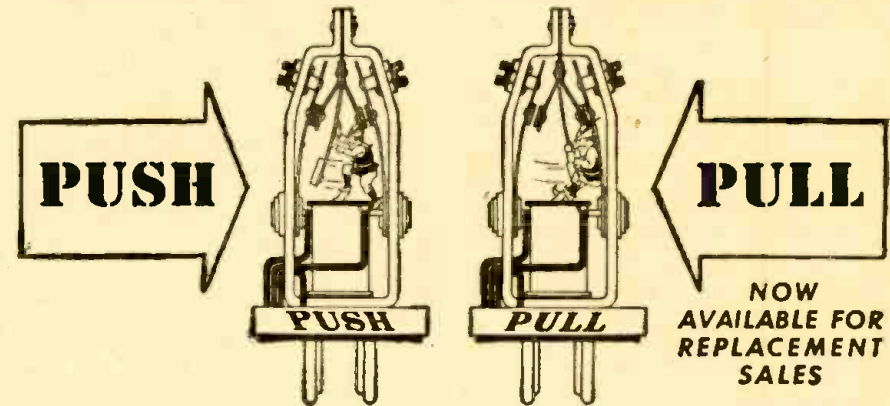

**SYNCHRONOUS AND NON-SYNCHRONOUS TYPES**

Over the years the James Vibrator has become famous for long life and extreme dependability. Note these outstanding features: (1) Patented Push-Pull Action (2) Frame-Mounted cooler-operating reeds (3) Adjustable contacts.

The war years and various shortages have kept the James Vibrator in short supply. New production facilities now permit prompt shipments on replacement vibrators of all types.

Ask your Radio Parts Distributor. Write for Interchangeability Chart, price list and catalog.

**JAMES VIBRAPOWER CO.**

3224 W. Armitage Ave.

Chicago 47, Illinois

# RADIO SCHOOL DIRECTORY

PREPARE NOW FOR SKILLED JOBS IN RADIO AND ELECTRONICS

## PRACTICAL TECHNICAL TRAINING

SPECIALIZE in 6 months to 3 years

### COURSES

#### SERVICE

- 6 to 12 Months
- Electricity
- Welding
- Refrigeration
- Heating

#### TECHNICIAN

- 1 to 2 Years
- Electricity
- Radio
- Electronics
- Refrigeration, Heating and Air Conditioning

#### PROFESSIONAL

- 3 Years
- Electrical Engineering Bachelor of Science Degree
- Major in Machinery or Electronics

Train in Electronics, Radio, Electricity for a substantial career in industry—or a business of your own. Prepare in one year to be a Technician—or in two additional years secure a Bachelor of Science Degree in Electrical Engineering with major in Electronics. More than 35,000 former students in industries the world over. 1,538 students now enrolled from 48 states and 13 overseas countries. Faculty of 72 specialists. Write for catalog and Personal Guidance Questionnaire.

Terms start APRIL, July, Sept.



Dept. RC-248

North Broadway, Milwaukee, Wis.

## CAREERS in RADIO

INTENSIVE COURSES—Thorough, technical education for progressive men and women.

Licensed by the State of New York

1. RADIO TECHNICIAN—The MRI General Course. Includes F.M. & Television. Prepares for FCC Broadcast Licenses.
2. RADIO & TELEVISION SERVICING—Prepares for employment as Repairman on Standard Broadcast, F.M. & Television Receivers.
3. RADIO COMMUNICATIONS—Prepares for FCC Operators' License. Leads to position as Merchant Marine or Flight Radio Officer; Commercial Operator.
4. FUNDAMENTAL RADIO MATHEMATICS—The MRI Preparatory Course. Required pre-training for students lacking a basic mathematical background.

### MELVILLE RADIO INSTITUTE

MELVILLE BUILDING  
15 WEST 46TH ST., N. Y. 19. LO. 4-0340

"The Radio School Managed By Radio Men"

### MELVILLE RADIO INSTITUTE

MELVILLE BUILDING  
15 West 46th St., N. Y. 19, N. Y.

GENTLEMEN: RC  
Send me FREE information about your school.

Name.....

Address.....

MAIL THIS COUPON NOW

## TELEVISION

Practical and Theoretical Technicians Course, covering all phases of Radio, Frequency Modulation, Television, leads to opportunities in Industry, Broadcasting or own Business. Day and Eve. Sessions. Licensed by N. Y. State. Approved for Veterans.

ENROLL NOW FOR NEW CLASSES

Visit, Write or Phone

### RADIO-TELEVISION INSTITUTE

Pioneers in Television Training Since 1938  
490 Lexington Ave., N. Y. 17 (46th St.)  
Plaza 3-4585 2 blocks from Grand Central

LEARN

## RADIO

Get F.C.C. License  
RADIO — TELEVISION  
Repairing

Classes start every month  
Our organization engaged in TECHNICAL TRAINING for 27 Years  
LITERATURE ON REQUEST

BALTIMORE TECHNICAL INSTITUTE  
1425 Eutaw Place, Balto. 17, Md.

APPROVED FOR VETERANS



## RADIO COURSES

Preparatory, Service, Broadcast, Television, Marine Operating, Aeronautical, Frequency Modulation, Radar.

Classes now forming for mid-year term  
Feb. 2nd. Entrance Exam. Jan. 12th.  
Veterans. Literature.

COMMERCIAL RADIO INSTITUTE  
(Founded 1920)  
38 West Biddle Street, Baltimore 1, Md.



### RCA INSTITUTES, Inc.

Offer thorough training courses in all technical phases of

### Radio and Television

DAYS—EVENINGS WEEKLY RATES  
VETERANS: RCA Institutes is approved under G. I. Bill of Rights  
For Free Catalog Write Dept. RC-48

### RCA INSTITUTES, Inc.

A Service of Radio Corporation of America  
78 VARICK STREET NEW YORK 13, N. Y.

## A CAREER WITH A FUTURE!

# TELEVISION

Shop Work · Shop Techniques · Theory  
FULLY EQUIPPED LABORATORIES

- RADIO SERVICE & REPAIR
- F. M. & TELEVISION
- TRANSMITTER COURSES  
*Preparing for F.C.C. LICENSES*
- RADIO TECHNOLOGY  
*A Junior College Level Course preparing for positions in Radio-Electronic Engineering Field.*

MORNING · AFTERNOON · EVENING CLASSES  
MODERATE RATES · INSTALLMENTS

Available Under G. I. Bill  
COME IN AND SEE OUR STUDENTS AT WORK

## DELEHANTY SCHOOL OF

RADIO · ELECTRONICS · TELEVISION  
105 EAST 13 ST., N. Y. 3, N. Y. · DEPT. T  
LICENSED BY STATE OF NEW YORK

### CORRESPONDENCE COURSES IN

## RADIO and ELECTRICAL ENGINEERING

**ELECTRICAL ENGINEERING** Get good grasp of wide electrical field. Prepare yourself at Low Cost, for secure future. Modern course. So simplified anyone can understand quickly.

**RADIO ENGINEERING** Extra fine course in radio, public address, photo-electric work. Trains you to be super-service man, real vacuum-tube technician. Servicemen needed badly. Diploma on completion. Many graduates earning big pay.

Send postcard for Free Copies of school catalog, full details, all \$25 Either about deferred payment plan, ex- perimental kits, etc.

Lincoln Engineering School, Box 931C-108, Lincoln 2, Nebr.

## SOUND RECORDING SCHOOL

A practical 9 months' course in Sound Fundamentals, Recording, and Sound Transmission measurements; in a laboratory containing transmission sets, oscillators, square wave generator and intermodulation analyzer, and other equipment.

Two complete recording studios assimilating broadcast, motion picture and commercial sound recording, under the direction of H. M. Tremaine.

Approved for Veterans  
DON MARTIN SCHOOL OF RADIO ARTS  
1655 Cherokee St., Hollywood, Calif.

## RADIO

TECHNICIAN and RADIO SERVICE COURSES  
FM and TELEVISION

AMERICAN RADIO INSTITUTE  
101 West 63rd St., New York 23, New York  
Approved Under GI Bill of Rights  
Licensed by New York State

## Radio Technician and Announcers

A practical 15-month course in First Class Radiotelephone Operation and Announcing is offered by Don Martin School of Radio Arts. Most stations these days require combination men. We specialize in this type of training and maintain a placement bureau for our graduates. Serving the industry for 10 years, the School of Radio Arts can train you. Write for our catalogue outlining the courses offered. Classes can be arranged so you can do part time work on the side.

APPROVED FOR VETERANS  
DON MARTIN SCHOOL OF RADIO ARTS  
1655 North Cherokee St. Hollywood 28, Calif.

Hollywood Experts Help You **Make Good in RADIO-TELEVISION** at Home

Direct from Hollywood, nerve-center of broadcasting, Television, Radio and Sound activities, comes R-T-A's time-proven and tested home training. Here at last—easy to learn, home instruction that quickly qualifies you for steady, good-pay jobs or your own Radio business. 10 big kits of radio parts given at no extra charge. Get full details at once! Send postal for FREE BOOK "How to Make Good in Radio-Television." R-T-A APPROVED FOR VETERANS.

RADIO TRAINING ASS'N OF AMERICA, Dept. RCB  
5620 Hollywood Blvd. Hollywood 28, Calif.

## CODE SENDING SPEED

Be a "key" man. Learn how to send and receive messages in code by telegraph and radio. Commerce needs thousands of men for jobs. Good pay, adventure, interesting work. Learn at home quickly through famous Candler System. Write for FREE BOOK.

CANDLER SYSTEM CO.  
Dept. 3, E, Box 528, Denver 1, Colo., U.S.A.



# BOOK REVIEWS

**TELEVISION TECHNIQUES**, by Hoyland Bettinger. (With drawings by the author.) Published by Harper & Brothers. Stiff cloth covers, 6 x 8½ inches, 237 pages. Price \$5.00.

Working on the principle that "the basic factors of television showmanship are not new, but are as old as the arts from which they are derived," the author proceeds—after a brief introductory chapter to put the reader at ease with the electronic principles of television—to relate his subject to these older arts.

He deals first with the medium, indicating the limitations as well as possibilities of both sight and sound as transmitted on the television carrier. A long and well-illustrated chapter on pictorial composition and continuity is then followed by one on the video or actual camera technique and another on audio technique. Other chapters deal with television writing, directing and producing, staging the play, the use of film and moving-picture techniques in television programs, and television lighting.

The presentation is directed to the nontechnical user of television or worker in the television field: to the writer, sponsor, advertising agent, studio crew, motion picture field unit, and performers.

**FLUORESCENT LIGHTING MANUAL (Second Edition)**. By Charles L. Amick. Published by McGraw-Hill Book Co. Stiff cloth covers, 6 x 9 inches, 318 pages. Price \$4.00.

Written by a member of the General Electric Lamp Department, this is a complete and up-to-date treatise on fluorescent lighting. It covers not only the elementary subjects expected in a practical manual written in language simple enough for the average installa-

tion man, but deals also with illumination problems from the viewpoint of the engineer, discusses fluorescent lighting design, and devotes a chapter to lighting economics.

A historical sketch and discussion of modern lamps and auxiliary equipment present the fluorescent lamp to the person previously unfamiliar with the subject. Operating hints, installation, and service suggestions are more interesting to the electrician actively engaged in installing lamps; and several chapters on selection and design, color quality and fluorescent applications are useful to the illumination engineer.

**SUNSPOTS IN ACTION**, by Harlan True Stetson, Ph.D., with a foreword by Sir Edward V. Appleton. Published by the Ronald Press Co. Stiff cloth covers, 6 x 8½ inches, 252 pages. Price \$3.50.

The importance of sunspots in radio is apparent to all who have noted the great increase in maximum usable frequencies during the present period of maximum sunspot activity. Reports of reception of American FM stations have been received in Australia; the Atlantic Ocean has been spanned by amateur communication signals on 6 meters and Chicago FM or New York police radio interference mars the images on London television screens. The radioman is very much interested in sunspots as a factor in radio propagation conditions.

Four chapters of Dr. Stetson's work deal with radio, covering the subjects of the effect of sunspots on communications, their importance as a factor in radio predictions, the effect of moonlight on radio, and the recent sunspot maximum's part in the recent FCC actions in regard to FM and other frequency allocations.



Suggested by James Eastcott, Hamilton, Ontario, Canada.

"This set used too many acorn tubes!"

## NOW—A REALLY HIGH-POWERED— Radio Engineering Library

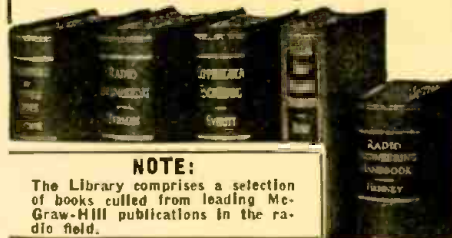

**NOTE:**  
The Library comprises a selection of books culled from leading McGraw-Hill publications in the radio field.

- especially selected by radio specialists of McGraw-Hill publications
- to give most complete, dependable coverage of facts needed by all whose fields are grounded on radio fundamentals
- available at a special price and terms

THESE books cover circuit phenomena, tube theory, networks, measurements, and other subjects—give specialized treatments of all fields of practical design and application. They are books of recognized position in the literature—books you will refer to and be referred to often. If you are a practical designer, researcher or engineer in any field based on radio, you want these books for the help they give in hundreds of problems throughout the whole field of radio engineering.

**5 VOLUMES, 3319 PAGES, 2289 ILLUSTRATIONS**

1. Eastman's FUNDAMENTALS OF VACUUM TUBES
2. Terman's RADIO ENGINEERING
3. Everitt's COMMUNICATION ENGINEERING
4. Hund's HIGH FREQUENCY MEASUREMENTS
5. Henney's RADIO ENGINEERING HANDBOOK

10 days' examination. Easy terms. Special price under this offer less than books bought separately. Add these standard works to your library now; pay small monthly installments, while you use the books.

10 DAYS' FREE EXAMINATION—SEND COUPON

McGraw-Hill Book Co., Inc. 330 W. 42nd St., N. Y. C. 18

Send me Radio Engineering Library, 5 vols., for 10 days' examination on approval. In 10 days I will send \$2.50, plus few cents postage, and \$5.00 monthly till \$27.50 is paid, or return books postpaid. (We pay postage on orders accompanied by remittance of the first installment.)

Name .....  
Address .....  
City and State .....  
Company .....  
Position ..... RC-2-48

Prepare For A Good Job Now in

# RADIO

SOUND and TELEVISION  
in a Few Short Weeks

LEARN QUICKLY IN  
THE GREAT SHOPS OF

# COYNE

Get ready for a better job, bigger pay NOW in Radio. Cash in with "All-around" knowledge of Radio—Sound—Television. Train on actual equipment not by "Home-study". You learn quickest at COYNE because it's a real SHOP course!

**G. I. APPROVED...also Finance Plan for NON-VETERANS.** Don't let lack of cash hold you back. Many earn while learning. FREE Employment Service to graduates. Get facts today!

**SEND COUPON FOR FREE BOOK**

Send at once for Big Free Book on Radio, Sound and Television, and facts about our Finance Plan.

MAIL THIS COUPON TODAY

B. W. COOKE, Pres.,  
Coyne Electrical and Radio School  
500 S. Paulina St., Dept. 28-8H, Chicago 12, Ill.

Please send Big FREE Book and complete details.

NAME .....  
STREET .....  
CITY ..... STATE .....

# AMATEURS! HAMS! EXPERIMENTERS!

Now — TRANSMITTING TUBES AT SENSATIONALLY LOW PRICES!

J. A. N. Inspected.

1625 TRANSMITTING Beam Power, Amplifier. Same as 807 except 12.6 volt filament medium, 7 pin base. . . . . **14c ea.**

836 Half-Wave High Vacuum Rectifier. Ratings—5000 volt maximum. Heater—2.5 volt at 5 amps. . . . . **39c ea.**

836A/3B27 Half Wave High Vacuum Rectifier . . . . . **99c ea.**

829 Push Pull twin-unit. Beam power amplifier tube. . . . . **\$1.49 ea.**

## 4E27/HK257B BEAM POWER AMPLIFIER

with an enclosed tantalum anode. Medium metal shell. Giant 7-pin, bayonet base. Wire top terminal. Cathode 5 volts—7.5 amps. Transconductance Micro-Mhos—2800. Class of Service—C-P. Maximum plate ratings—4000 volts. DC Input—250 W.

Only \$1.95 each



OD3/VR150 — Voltage Regulator Tube . . . . . **49c ea.**

25% deposit on all orders, balance C.O.D.. F.O.B. New York

## SENCO RADIO, Inc.

96A WARREN ST., N. Y. 7, N. Y.  
TEL. BECKMAN 3-6498

## TELEVISION RECEIVER—\$1.00

Complete instructions for building your own television receiver. 16 pages—11"x17" of pictures, pictorial diagrams, clarified schematics. 17"x22" complete schematic diagram & chassis layout. Also booklet of alignment instructions, voltage & resistance tables and troubleshooting hints.—All for \$1.00.

CERTIFIED TELEVISION LABORATORIES  
5507-13th Ave., Brooklyn 19, N. Y.

# WHY PAY MORE?

equip yourself for the RICH FM BUSINESS in your community for only \$19.95

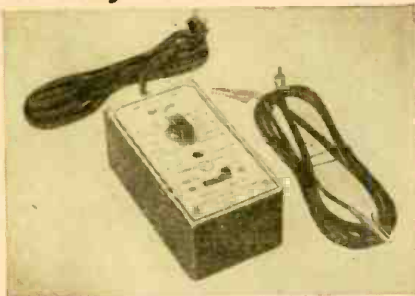

FM SIGNAL GENERATOR MODEL 720

R. C. P. scores another first with this new low-cost accurate, pocket size FM Signal Generator! Start cashing in now on the rich FM business in your community—not by investing 100 dollars—or even 50—but with only \$19.95. Order this extra profit-building FM Signal Generator from your R. C. P. jobber today. Only \$19.95 for an accurate instrument that permits you to align and service FM receivers.

- ★ Complete with tubes ready to operate
- ★ Pocket size 3" x 6" x 2 3/4"
- ★ Completely shielded and isolated from line
- ★ Calibration, accurate within 1% for fixed frequencies of 10.7, 88, 98 and 108 mc.
- ★ Individual trimmers for recalibration
- ★ Equipped with shielded output lead

Send for R. C. P.'s complete new catalog of economy-priced, quality-built precision instruments. Before you buy any instrument—see R. C. P. first! It's best for every test.

## RADIO CITY PRODUCTS CO., INC.

152 West 25th Street, New York 1, N. Y.

## Advertising Index

Abell Distributing Company	72
Air King Radio	Inside Front Cover
Allied Radio Corporation	41
Almo Radio Company	77
American Surplus Products	2
American Television, Inc.	11
Amplifier Corporation of America	69, 83, 85
Apex Video Company	81
Arrow Sales, Inc.	85
Audel Publishers	77
Bell Telephone Laboratories	8
Boland & Boyce, Inc., Publishers	82, Back Cover
Bonafide Radio Company	74
Brooks Radio Distributing Company	72
Browning Laboratories	72, 84
Buffalo Radio Supply	52, 53
Burstein-Applebee Company	88
Buyers Syndicate	83
Capitol Radio Engineering Institute	13
Certified Television Laboratories	88
Cleveland Institute of Radio	51
Commercial Radio	84
Communications Equipment Co.	6
Cofcord Radio Corporation	12
Coradio	70
Coyne Electrical School	73, 87
Deer & Taylor	83
DeForest's Training Institute	7
Edlie Electronic, Inc.	71
Eichel Electronics Corp.	78
Electronic Distributors	79
Espey Manufacturing Co., Inc.	65
Esse Radio Company	14, 15
Fair Radio Sales	88
General Cement Mfg. Co.	69
General Electronic Distributing Co.	Inside Back Cover
General Test Equipment Co.	73
Green Radio Distributor	78
Greylock Electronic Supply Co.	83
The Hallderson Company	71
The Heath Co.	61
Hershel Radio Company	57
Charles Hoodwin Company	78
Hoover Industries	44
Hudson Specialties	80
Instructograph Company	83
International Telephone & Telegraph Co.	64
Joyce Radio Distributors	56
Lafayette Radio	75
Leeds Radio Company	81
Leonard Radio, Inc.	82
Leotone Radio Corp.	62
McGraw-Hill Book Co., Inc.	49, 87
McMurdo Silver Company	4
P. R. Mellory & Co., Inc.	3
Maritime Switchboard	60
Merit Products	83
Metropolitan Electronic & Instrument Co.	75
Mid-America Company	66
Minor Machine Corp.	75
Moss Electronic Distributing Co.	43
National Plans	67
Murray Hill Books, Inc.	63, 80
National Radio Institute	1
National Schools	9
Newcomb Audio Products Company	47
Niagara Radio Supply	73, 77, 83, 84
Ohio Factory Sales	76
Ohmite Manufacturing Company	58
Olson Radio Warehouse	64
Opportunity Adlets	69
Pakette Radio Company, Inc.	79
Plastics Research Company	83
Potter Radio Company	81
Precision Apparatus Company	70
Progressive Electronics Company	55

## RADIO SCHOOL DIRECTORY (See Page 86)

- American Radio Institute
- Baltimore Technical Institute
- Candler System Company
- Commercial Radio Institute
- Delehanty Institute
- Lincoln Engineering School
- Don Martin School of Radio Arts
- Melville Radio Institute
- Milwaukee School of Engineering
- Radio-Television Institute
- Radio Training Association of America
- RCA Institutes

Radio City Products	88
Radio-Craft	68, 70
Radio Dealers Supply Company	76
Radio Distributing Company	85
Radio Kits Company	88
Radio Publications	73
Radio Supply & Engineering Company	39
Radio Wire Television, Inc.	75
Radionic Equipment Company	67
Radolek Company	84
Ravac Electronics Corporation	81
Reed Manufacturing Company	76
Howard W. Sams Company, Inc.	45
Walter L. Schott Company	79
Schuh's Radio Parts	88
Senco Radio, Inc.	50, 88
Sprague Products Company	14
Sprayberry Academy of Radio	5
Star Measurements Company	72
Sterling Electronics	85
Supreme Publications	59

## BARGAIN SPECIAL

### 'Tops' in Headphones

At a Fraction of Original Cost

8000-ohm impedance, highly sensitive. Best quality Alnico magnets in molded black bakelite cases, concealed terminals. Headband fully adjustable, leather covered spring steel 12" cord with PL54 plug attached at side out of way. Jack and rubber cord supplied to extend length to 5 1/2 ft.

Extremely lightweight, only 9 oz., with removable rubber ear cushions of comfortable design Brand New—a 13.50 Value.

Stk. No. 17A37, Special Per Pair **\$1.95**

**ORDER NOW, from this ad Add Postage**

## FREE Catalog

Many other BARGAINS in this BIG NEW 1948 B-A Catalog.

Latest developments in Radio and Electronic parts and devices, newest Ham gear.

Write if you have not received it—Cot. No. 481 FREE on request.

## BURSTEIN-APPLEBEE

1012-14 Mc GEE STREET, Company  
KANSAS CITY 6, MISSOURI

## B19 MARK II TECHNICAL DATA

A.C. Conversion Diagram, postpaid	\$ .50
Schematic Diagram with Parts and Value List, postpaid	.50
Service Manual—Alignment and Test Procedure. Socket Voltages, Parts Layout, Engineering Hints for curing faults. Schematic and Block Diagram, etc., postpaid	1.50

0-500 MICROAMMETER: 0-600 and 0-15 D.C. volt scale, luminous dial, with multipliers. **\$2.50 ea.**

Price

WE CAN FURNISH ANY ITEM FOR B19 SETS!  
No. C.O.D. orders. Shipments F.O.B. Lima, Ohio

## FAIR RADIO SALES

223 S. MAIN ST. • LIMA, OHIO

## CIRCUIT TESTER

CAN BE USED IN PLACE OF MULTIMETER!

Complete with Instruction Book **\$3.95**

TESTS: Indicates AC and DC Voltages  
Fuses • Resistances of Circuits • Capacitors • etc. Unit in small strong metal box. Weighs approx. 2 lbs. Test leads provided. Power may be supplied to test unit from 115 to 130 V. AC or DC NEW. Shipped Medium

In original sealed metal containers. Shipping Wt. 3 1/4 lbs. F.O.B. Chicago, Ill.

**SCHUH'S RADIO PARTS** 1253 Loyola Ave., Chicago 26, Ill.

## VALUABLE COUPON—SCOOP

TUBES—(Std. Brand.) 5Y3GT	3 for \$1.00
TUBES—(Std. Brand.) 125A7	2 for 1.00
MALLORY COND.—40-20 Mfd 150v. FP.	2 for 1.00
P.B. CONDENSER—20-20 Mfd 150v.	3 for 1.00
BY-PASS COND.—.005 or .01 Mfd 500v.	18 for 1.00
TREBOR IF COILS 455 KC (1 1/2 x 2 1/2)	2 for 1.00
OSCIL. COILS 455 KC (for 125A7)	3 for 1.00
LOOP ANTENNA HI Gain (5x27)	3 for 1.00
RESISTOR KIT 50 Ass'd 1/3 to 1 Watt.	3 for 1.00
OUTPUT TRANS. 2000-3 or 7000-3 Ohms 2 for 1.00	
DIAL CORE—50 Ft. Spools Std. or Medium	2 for 1.00

• COMBINATION KIT of All Above Items for Only **10.00**

With This Coupon—Order at Once

RADIO DISTRIBUTING CO. Pasadena 18, Cal.

Technical Radio Parts Co.	77
Radio, Inc.	84
Transvision, Inc.	54
Turner Company	56
Universal General Corp.	72
University Loudspeakers, Inc.	81
James Vibrapower	85
Wright, Inc.	71
X.L. Radio Laboratories	79
York Distributing Co.	84

**MONEY BACK GUARANTEE** — We believe units offered for sale by mail order should be sold only on a "Money-Back-If-Not-Satisfied" basis. We carefully check the design, calibration and value of all items advertised by us and unhesitatingly offer all merchandise subject to a return for credit or refund. You, the customer, are the sole judge as to value of the item or items you have purchased.

## The Model 88-A COMBINATION **SIGNAL GENERATOR** **AND** **SIGNAL TRACER**



The Model 88 comes complete with all test leads and operating instructions.

ONLY

**\$28<sup>85</sup>**  
**NET**

We're prepared for the demand we know will be created by this long overdue combination of the two units which have always been used together. The ultimate in signal tracing procedure is achieved by the Model 88, for the use of this model, enables you to use either the broadcast signal itself or the signal injected by the Signal Generator. This is especially useful of course when servicing "dead" or "intermittent" receivers. The Model 88 you will find is the greatest time-saver ever provided for by combining a full range Signal Generator and Signal Tracer into one unit the set up time for interconnecting, etc., is entirely eliminated.

**Signal Generator Specifications:**

- ★ Frequency Range: 150 Kilocycles to 50 Megacycles.
- ★ The R.F. Signal Frequency is kept completely constant at all output levels. This is accomplished by use of a special grid loaded circuit which provides a constant load on the oscillatory circuit. A grounded plate oscillator is used for additional frequency stability.
- ★ Modulation is accomplished by Grid-blocking action which has proven to be equally effective for alignment of amplitude and frequency modulation as well as for television receivers.
- ★ Positive action attenuator provides effective output control at all times.
- ★ R.F. is obtainable separately or modulated by the Audio Frequency.

**Signal Tracer Specifications:**

- ★ Uses the new Sylvania 1N34 Germanium crystal Diode which combined with a resistance-capacity network provides a frequency range of 300 cycles to 50 Megacycles.
- ★ Simple to Operate—Clips directly on to receiver chassis, no tuning controls.
- ★ Provision is made for insertion of phones of any impedance, a standard Volt-Ohm Milliammeter or Oscilloscope.

## The New Model 777 **20,000 OHMS PER VOLT!!**

### **SET TESTER**



**TUBE TESTER SPECIFICATIONS:**

- Tests all tubes including 4, 5, 6, 7, 7L, Octals, Loctals, Television, Magic Eye, Thyratrons, Single Ended, Floating Filament, Mercury Vapor Rectifiers, New Miniatures, etc. Also Pilot Lights.
- Tests by the well-established emission method for tube quality, directly read on the scale of the meter.
- Tests leakages and shorts of any one element against all elements in all tubes.
- Tests both plates in rectifiers.
- Tests individual sections such as diodes, triodes, pentodes, etc., in multi-purpose tubes.
- New type line voltage adjuster.

**V.O.M. SPECIFICATIONS:**

- D.C. VOLTS: (at 20,000 Ohms Per Volt) 0 to 75/15/75/150/750/1,500 Volts
- A.C. VOLTS: (At 10,000 Ohms Per Volt) 0 to 15/30/150/300/1,500/3,000 Volts
- D.C. CURRENT: 0 to 1.5/15/150 Ma. 0 to 1.5 Amperes
- RESISTANCE: 0 to 5,000/50,000/500,000 Ohms 0 to 50 Megohms
- DECIBELS: (Based on zero decibels equals .006 Watts into a 500-Ohm line.) -10 to + 18 db., + 10 to + 38 db., + 30 to + 58 db.

Model 777 operates on 90-120 Volts 60 cycles A.C. Housed in beautiful hand-rubbed cabinet. Complete with test leads, tubes, charts and detailed operating instructions. Size 13" x 12 1/2" x 6".

**\$59<sup>95</sup>**  
**NET PRICE**

**20% DEPOSIT REQUIRED ON ALL C.O.D. ORDERS**

**GENERAL ELECTRONIC DISTRIBUTING CO. DEPT. RC-2 98 PARK PLACE, NEW YORK 7, N. Y.**

# NOW!

## AT YOUR JOBBER'S THE RADIO DATA BOOK— OVER 1000 PAGES!

All data and basic knowledge  
in radio and electronics  
digested into 12 sections...  
in a complete, quick to find,  
easy to read, handbook form.

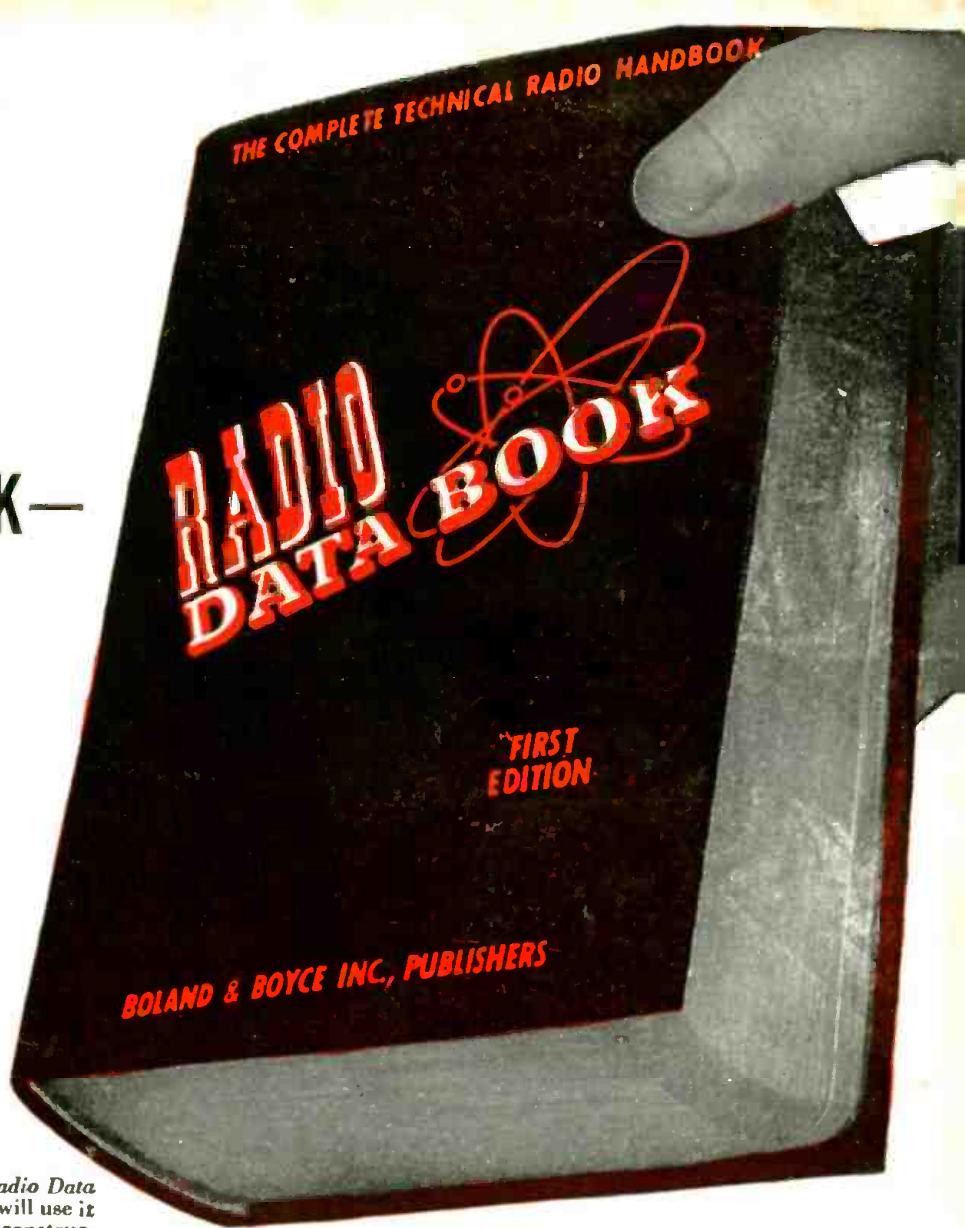

Plan every operation in radio and electronics with the *Radio Data Book*. This new radio bible will be your lifelong tool... you will use it every day, on the board, at the bench, in the field! Use it for construction, troubleshooting and testing. The RADIO DATA BOOK will be your invaluable aid in design, experiment and in layout. It will help make your production better, faster and easier. In any and every operation in radio and electronics, you will use the RADIO DATA BOOK!

The RADIO DATA BOOK is a work of complete authority, prepared by engineers with many years of practical experience. They have been assisted by the Boland & Boyce staff of editors skilled in preparing electronics manuals for the U. S. Signal Corps for many years. These men have worked for several years gathering material for this book... all the knowledge of radio principles and operation... all the statistics... all the newest developments in electronics... every possible angle and detail. Eighteen months were spent digesting this material into the most concise, the clearest, and the most readable form. The result is this invaluable manual... The RADIO DATA BOOK. Whether you use this book for general reference, for scientific instruction, or for education, one thing is certain—the practical help, the daily usefulness you will derive from it will prove to be worth many, many times its astonishingly low price!

Advanced Sale... first printing, Only 10,000 available... To make sure to get your RADIO DATA BOOK, mail your order **NOW!**

Handsomely bound in RED and GOLD

12 complete books in one only **\$5.00!** Less than 42c per book

### Contents

- Each section is a COMPLETE coverage of its subject... 12 sections... 12 books in ONE! 1000 pages... Schematics... Accurate photographs... Specially prepared drawings... White on black charts... Diagrams... Isometric projections and exploded views.
- Section 1. THE 150 BASIC CIRCUITS IN RADIO.  
Every circuit is analysed and explained in a Johnny-on-the-spot reference for any occasion.
  - Section 2. COMPLETE TEST EQUIPMENT DATA.  
Know more about the test instruments you now have... Find the new ones you want to buy... They're All in here—impartially described!
  - Section 3. TESTING, MEASURING AND ALIGNMENT.  
Simplified operation of the Oscilloscope... See what's happening inside any radio circuit... Dynamic alignment—AM, FM and TELEVISION made easy with the Oscilloscope... Scientific use of the Vacuum Tube Voltmeter, Signal Generating Equipment and other basic instruments.
  - Section 4. ALL ABOUT ANTENNAS.  
AM-FM-Television... design, installation, characteristics, construction and feed.
  - Section 5. SOUND SYSTEMS.  
Planning, installing and servicing a PA System. A complete chapter on every component... How to select and combine components... estimating costs... even acoustic requirements!
  - Section 6. ELECTRICAL AND PHYSICAL CHARACTERISTICS OF RADIO COMPONENTS.  
Know the size, the power, the shape! A quick reference on the construction and design of any circuit or equipment.
  - Section 7. COMPLETE TUBE MANUAL: Receiving, transmitting and Commercial.  
A flick of the pages brings you to all the data and ratings of any tube model
  - Section 8. CHARTS, GRAPHS AND CURVES.  
Quick calculation devices... Plotting curves, nomographs, rules and tables for speedy solutions to radio problems.
  - Section 9. CODES, SYMBOLS AND STANDARDS.  
Handy reference to all radio symbols and abbreviations; code symbols, phrases and characters... Where you want them... When you want them!
  - Section 10. 50 TESTED CIRCUITS DESIGNED FOR OPTIMUM PERFORMANCE.  
Find any circuit you want with complete parts lists and specifications... One tube receivers to complete AM, FM and Television receiver circuits... Amplifiers... Transmitters... Test Equipment and Control Circuits... All with the latest engineering refinements.
  - Section 11. DICTIONARY OF RADIO AND ELECTRONIC TERMS.
  - Section 12. RADIO BOOK BIBLIOGRAPHY.

**MAIL THIS COUPON TODAY!**

TO YOUR PARTS JOBBER OR DIRECTLY TO  
**BOLAND & BOYCE INC., PUBLISHERS**  
460 BLOOMFIELD AVE., MONTCLAIR, N. J.

Please send me a copy of

RC-2

**THE RADIO DATA BOOK** Enclosed is \$5.00.

NAME .....  
ADDRESS .....  
CITY ..... ZONE .....  
STATE .....

**BOLAND & BOYCE INC., PUBLISHERS**